



- Reacts quickly thanks to minimal break-away force
- Meets the highest requirements for running characteristics, service life and load carrying ability
- Extensive range of accessories

Specified types in accordance with ATEX directive for potentially explosive atmospheres

➔ www.festo.com/en/ex

Round cylinders DSNU/ESNU

Key features

At a glance

- Round cylinders with piston diameter from 32 to 63 mm
- The series is not repairable
- Piston rod and cylinder barrel made of stainless steel
- The cap is roller burnished onto the barrel
- Good running performance and long service life thanks to smooth, hard inner surface of cylinder barrel
- Three cushioning variants available
 - P cushioning
 - PPV cushioning
 - PPS cushioning

Wide choice of variants

DSNU-...

- Cylinder barrel made from stainless steel
- Bearing and end caps made from wrought aluminium alloy



DSNU/ESNU-...MA

- Bearing cap with flange thread
- Short end cap with axial air connection



DSNU-...MQ

- Bearing cap with flange thread
- Short end cap with lateral air connection



DSNU-...MH

- Direct mounting on the bearing cap
- Short end cap with lateral air connection



DSNU-...KP

- With clamping unit













Cushioning types

	P cushioning	PPS cushioning	PPV cushioning
Mode of operation	<ul style="list-style-type: none"> • The drive is equipped with polymer flexible end position cushioning 	<ul style="list-style-type: none"> • The drive is equipped with self-adjusting end position cushioning 	<ul style="list-style-type: none"> • The drive is equipped with adjustable end position cushioning
Application	<ul style="list-style-type: none"> • Small loads • Low speeds • Low impact energies 	<ul style="list-style-type: none"> • Small to medium loads • Low to medium speeds • Medium impact energies 	<ul style="list-style-type: none"> • Medium to high loads • High speeds • High impact energies
Advantages	<ul style="list-style-type: none"> • No adjustment required • Time-saving 	<ul style="list-style-type: none"> • No adjustment required • Time-saving • Powerful 	<ul style="list-style-type: none"> • Very powerful

Round cylinders DSNU/ESNU

Key features

Additional variants		
Symbol	Key features	Description
	S2 Through piston rod	For working at both ends with the same force in the forward and return stroke, for attaching external stops
	S6 Heat-resistant seals	Temperature resistance up to max. 120 °C
	S10 Constant motion (slow speed) at low piston speeds	Suitable for slow stroke movements at a constant, stick-slip-free speed over the full stroke of the cylinder. Seal contains silicone grease (not free of paint-wetting impairment substances)
	S11 Low friction	Special seals considerably reduce friction. This means a considerably lower response pressure. Seal contains silicone grease (not free of paint-wetting impairment substances)
	K2 Extended male piston rod thread	–
	K3 Female piston rod thread	–
	K5 Special piston rod thread	Metric standard thread to ISO
	K6 Shortened male piston rod thread	–
	K8 Extended piston rod	–
	R3 High corrosion protection	All external cylinder surfaces comply with corrosion resistance class 3 to Festo standard 940 070. The piston rod is made from corrosion and acid-resistant steel

Longer service life thanks to the bellows kit DADB



The bellows kit is a leak-free system. To prevent unwanted media being drawn in, the supply and exhaust air must be ducted via a pressure compensation hole in the connection part **1**.

The kit protects the piston rod, seal and bearings from a wide range of media, for example:

- dust,
- chips,
- oil,
- grease,
- fuel.

Round cylinders DSNU

Product range overview

FESTO

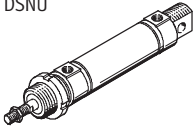
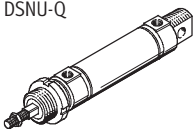
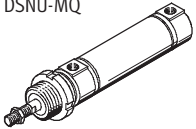
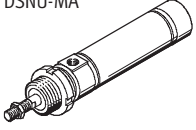
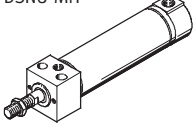
Function	Version	Piston Ø [mm]	Stroke [mm]	Variable stroke ¹⁾ [mm]	Piston rod						
					Through S2	Extended K8	Male thread			Female thread K3	
							Extended K2	Shortened K6	Special thread K5		
Double- acting	Basic version with position sensing										
	DSNU 	32, 40, 50, 63	25, 40, 50, 80, 100, 125, 160, 200, 250, 320	1 ... 500	■	■	■	■	■	■	
	Protected against rotation										
	DSNU-Q 	32	-	5 ... 300							
		40, 50	-	5 ... 400	■	■	■	■	■	■	
		63	-	5 ... 500							
	Lateral air connection										
DSNU-MQ 	32, 40, 50, 63	-	1 ... 500	-	■	■	■	■	■		
Axial air connection											
DSNU-MA 	32, 40, 50, 63	-	1 ... 500	-	■	■	■	■	■		
Direct mounting											
DSNU-MH 	32, 40, 50, 63	-	1 ... 500	-	■	■	■	■	■		

1) Cylinders with position sensing require a minimum stroke of 10 mm to ensure reliable sensing

Round cylinders DSNU

Product range overview

Version	Cushioning			Position sensing	Clamping unit	Heat-resistant seal	Slow speed (constant motion)	Low friction	Corrosion protection	Wiper seal	→ Page/ Internet
	Fixed	Adjustable	Self-adjusting								
	P	PPV	PPS								
Basic version with position sensing											
DSNU	■	■	■	■	■	■	■	■	■	■	11
Protected against rotation											
DSNU-Q	■	■	-	■	■	■	■	■	■	-	18
Lateral air connection											
DSNU-MQ	■	■	■	■	■	■	-	-	■	■	11
Axial air connection											
DSNU-MA	■	-	-	■	■	■	-	-	■	-	11
Direct mounting											
DSNU-MH	■	■	-	■	-	■	-	-	■	-	11

Round cylinders ESNU

Product range overview

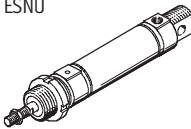
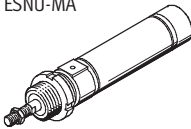

Function	Version	Piston \varnothing [mm]	Stroke ¹⁾ [mm]	Variable stroke [mm]	Fixed cushioning P	Position sensing A
Single-acting	Basic version with position sensing					
	ESNU 	32, 40, 50, 63	10, 25, 50	1 ... 50	■	■
	Axial air connection					
	ESNU-MA 	32, 40, 50, 63	–	1 ... 50	■	■

1) Cylinders with position sensing require a minimum stroke of 10 mm to ensure reliable sensing

Round cylinders ESNU

Product range overview

Version	Piston rod					→ Page/Internet
	Extended	Male thread			Female thread	
		Extended	Shortened	Special thread		
K8	K2	K6	K5	K3		
Basic version with position sensing						
ESNU	■	■	■	■	■	30
Axial air connection						
ESNU-MA	■	■	■	■	■	30

Round cylinders DSNU/ESNU

Peripherals overview

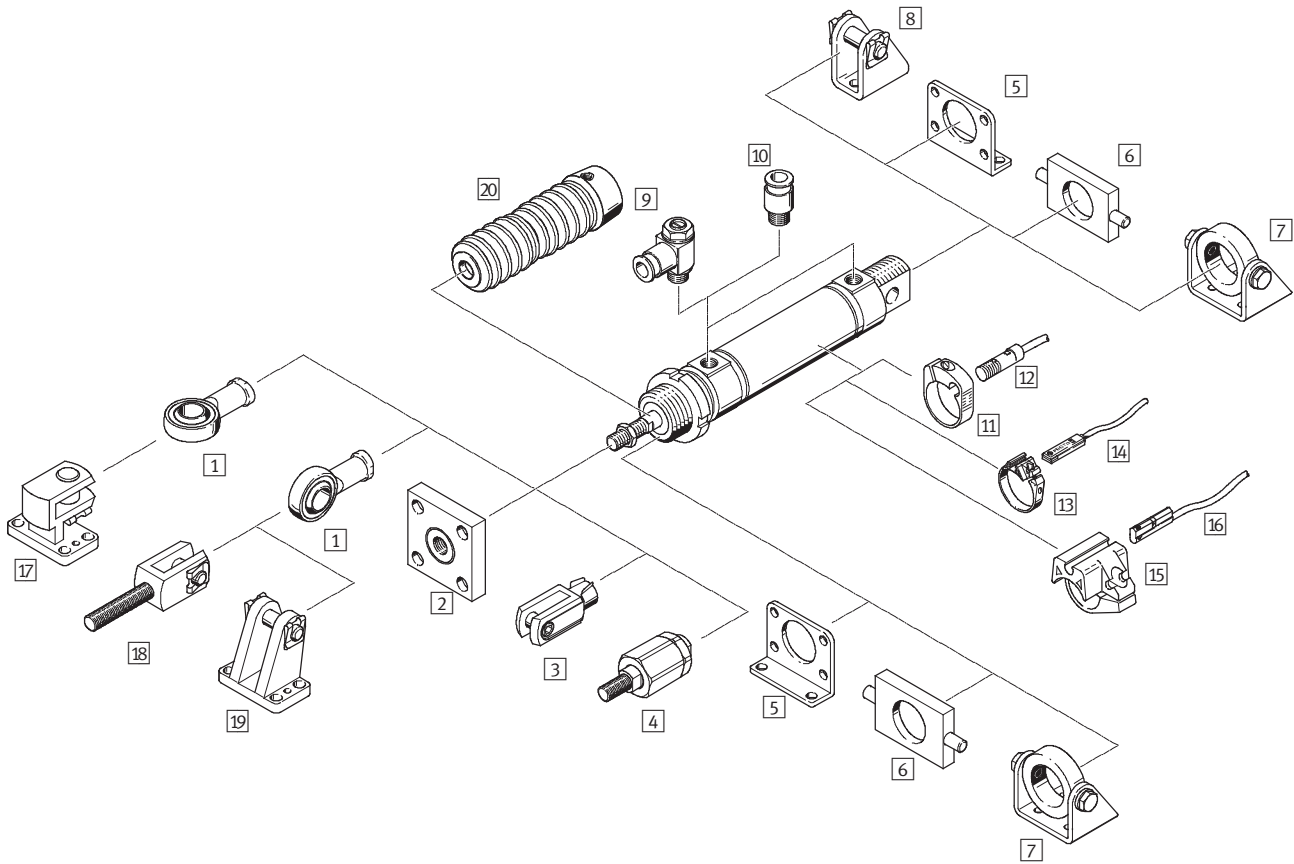

Variants

DSNU-MQ

DSNU-MA

DSNU-MH

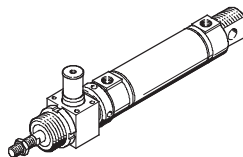
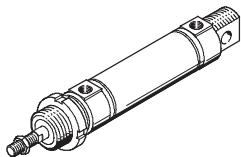
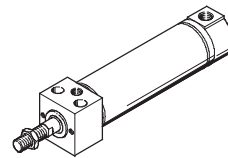
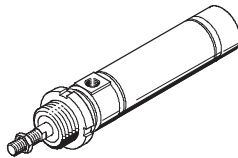
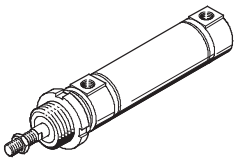

Mounting options

Mounting front and rear

Mounting via hex nut

Swivel mounting

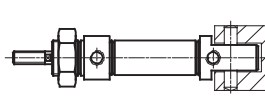
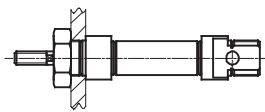
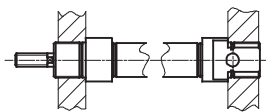

Foot mounting (for short strokes)

Foot mounting

Flange mounting

Swivel mounting

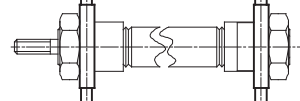
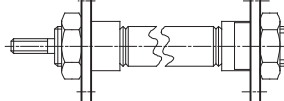
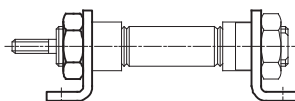
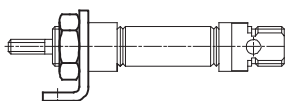

Round cylinders DSNU/ESNU

Peripherals overview

FESTO

Mounting attachments and accessories							
	DSNU/ESNU	DSNU/ESNU MA	DSNU MQ	MH	KP	DSNU-Q	→ Page/Internet
1	Rod eye SGS/CRSGS	■	■	■	■	■	39
2	Coupling piece KSG/KSZ	■	■	■	■	■	39
3	Rod clevis SG/CRSG	■	■	■	■	■	39
4	Self-aligning rod coupler FK	■	■	■	■	■	39
5	Foot mounting HBN/CRH	■	■	■	-	■	36
	Flange mounting FBN/CRFV	■	■	■	-	■	36
6	Swivel mounting ¹⁾ WBN	■	■	■	-	■	37
7	Swivel mounting ¹⁾ SBN	■	■	■	-	■	37
8	Clevis foot LBN/CRLBN	■	-	-	-	■	38
9	One-way flow control valve GRLA/GRLZ/CRGRLA	■	■	■	■	■	39
10	Push-in fitting QS	■	■	■	■	■	quick star
11	Mounting kit CRSMBR	■	■	■	■	■	44
12	Proximity sensor SMEO/SMT0/CRSMEO-4	■	■	■	■	■	44
13	Mounting kit SMBR-8	■	■	■	■	■	45
14	Proximity sensor SME/SMT-8	■	■	■	■	■	45
15	Mounting kit SMBR-10	■	■	■	■	■	46
16	Proximity sensor SME/SMT-10	■	■	■	■	■	46
17	Right-angle clevis foot LQG	■	■	■	■	■	38
18	Rod clevis SGA	■	■	■	■	■	39
19	Clevis foot LBG	■	■	■	■	■	38
20	Bellows kit ²⁾ DADB	■	■	■	-	-	38

-  - Note

1) Cannot be used on the bearing cap in combination with bellows kit DADB.

2) The bellows kit protects the cylinder (piston rod, seal and bearings) against a wide range of media and thus prevents premature wear.

It can only be used in combination with an extended piston rod (K8).

Round cylinders DSNU/ESNU

Type codes

FESTO

	DSNU	–	32	–	80	–	PPV	–	A	–	MQ
Type											
Double-acting											
DSNU	Round cylinder										
Single-acting											
ESNU	Round cylinder										
Piston Ø [mm]											
Stroke [mm]											
Cushioning											
P	Flexible cushioning rings/pads at both ends										
PPV	Pneumatic cushioning, adjustable at both ends										
PPS	Pneumatic cushioning, self-adjusting at both ends										
Position sensing											
A	Via proximity sensor										
Variant											
MQ	Lateral air connection										
MA	Axial air connection										
MH	With mounting flange on bearing cap										

Modular product system

Individually configurable

DSNU → 26

ESNU → 34

- Square piston rod (protection against rotation)
- Through piston rod (piston rod type)
- Extended male piston rod thread
- Male piston rod thread, shortened at one end
- Female piston rod thread (female thread)
- Special piston rod thread (special thread)
- Piston rod extended at front
- Clamping unit on the piston rod
- Heat-resistant seals for temperatures up to 120 °C (temperature resistance)
- Slow speed (constant motion at low piston rod speeds)
- Low friction
- All external cylinder surfaces conform to corrosion resistance class CRC 3 (corrosion protection)
- Dust protection (wiper seal)

Round cylinders DSNU

Technical data

FESTO

Function

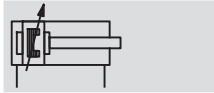
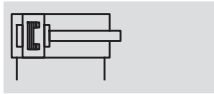

⊘ - Diameter
32 ... 63 mm

┆ - Stroke length
1 ... 500 mm

Variants

→ 16

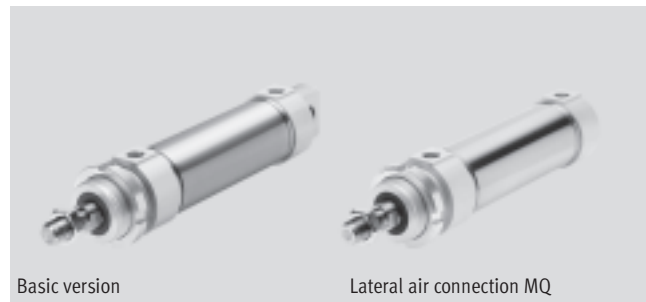

Basic version

Lateral air connection MQ

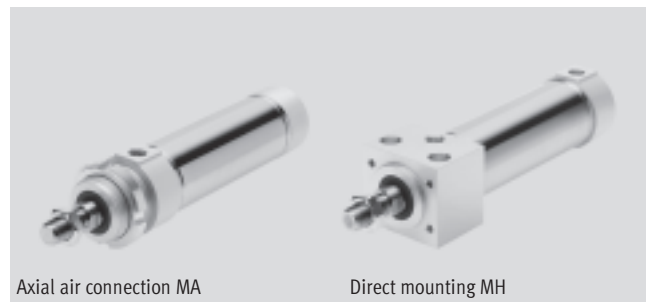

Axial air connection MA

Direct mounting MH

General technical data		32	40	50	63
Piston ∅		32	40	50	63
Pneumatic connection		G $\frac{1}{8}$	G $\frac{1}{4}$	G $\frac{1}{4}$	G $\frac{3}{8}$
Piston rod thread		M10x1.25	M12x1.25	M16x1.5	M16x1.5
Constructional design		Piston			
		Piston rod			
		Cylinder barrel			
Cushioning	P	Flexible cushioning rings/pads at both ends			
	PPV	Adjustable cushioning at both ends			
	PPS	Self-adjusting cushioning at both ends			
Cushioning length	PPV	[mm] 14	18	20	21
	PPS	[mm] 14	18	20	21
Position sensing		Via proximity sensor			
Type of mounting		Direct mounting (MH variant only)			
		Via accessories			
Mounting position		Any			

Operating conditions		32	40	50	63
Piston ∅		32	40	50	63
Operating medium		Compressed air in accordance with ISO 8573-1:2010 [7:4:4]			
Note on operating/pilot medium		Operation with lubricated medium possible (in which case lubricated operation will always be required)			
Operating pressure [bar]	Basic version	1 ... 10			
	S10	0.5 ... 10		0.4 ... 10	
	S11	0.2 ... 10	-	0.2 ... 10	

Ambient conditions		Basic version	S6	S10	S11	R3
Round cylinder		Basic version	S6	S10	S11	R3
Ambient temperature ¹⁾	[°C]	-20 ... +80	0 ... +120	+5 ... +80		-20 ... +80
Corrosion resistance class CRC ²⁾		2	2	2	2	3
ATEX		Specified types → www.festo.com				

1) Note operating range of proximity sensors.

2) Corrosion resistance class 2 as per Festo standard 940 070

Components subject to moderate corrosion stress. Externally visible parts with primarily decorative surface requirements which are in direct contact with a normal industrial environment or media such as coolants or lubricating agents.

Corrosion resistance class 3 as per Festo standard 940 070

Components requiring higher corrosion resistance. External visible parts in direct contact with industrial atmospheres or media such as solvents and cleaning agents, with a predominantly functional requirement for the surface.

Round cylinders DSNU

Technical data

FESTO

Speed [mm/s]		32	40	50	63
Piston \varnothing		32	40	50	63
Speed with stick-slip-free operation, horizontal, without load, at 6 bar	S10	8 ... 100			5 ... 100
Minimum speed, advancing	S11	<1 ¹⁾			
Minimum speed, retracting	S11	<1 ¹⁾			

1) Measurements of less than 1 mm/s were not conducted.

Force [N] and impact energy [J]		32	40	50	63
Piston \varnothing		32	40	50	63
Theoretical force at 6 bar, advancing		483	753	1,178	1,870
Theoretical force at 6 bar, retracting		415	633	990	1,682
Impact energy at the end positions for P cushioning ¹⁾		0.40	0.70	1	1.3

1) The values are reduced by approx. 50% at an ambient temperature of 80 °C.

Mean piston velocity v as a function of applied load m in combination with PPS cushioning

Piston \varnothing 32

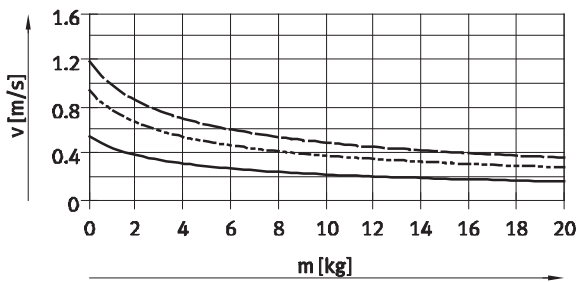

— DSNU-32-50
 - - - DSNU-32-100
 - · - DSNU-32-200

Piston \varnothing 40

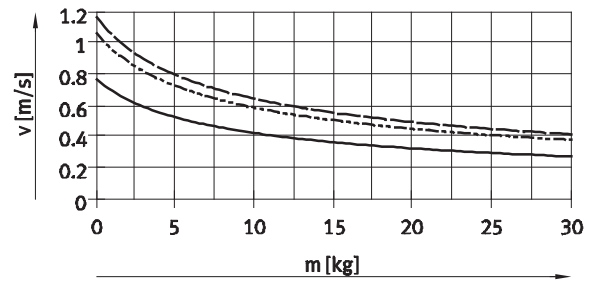

— DSNU-40-50
 - - - DSNU-40-100
 - · - DSNU-40-200

Piston \varnothing 50

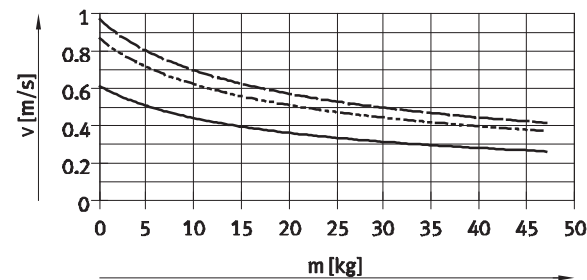

— DSNU-50-50
 - - - DSNU-50-100
 - · - DSNU-50-200

Piston \varnothing 63

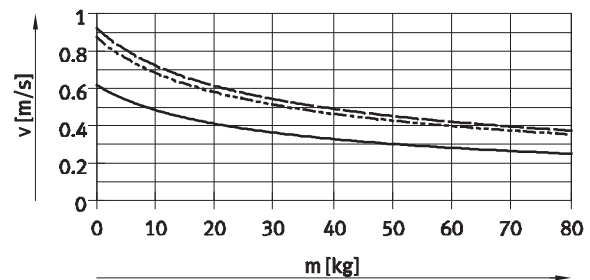

— DSNU-63-50
 - - - DSNU-63-100
 - · - DSNU-63-200

- · - Note
 Mean piston velocity
 = stroke/movement time

- · - Note

Design software for
 P cushioning
 → ProDrive

Additional graphs for
 PPS cushioning
 → www.festo.com

Design software for
 PPV cushioning
 → ProDrive

Round cylinders DSNU

Technical data

FESTO

Weight [g]				
Piston \varnothing	32	40	50	63
Product weight with 0 mm stroke	370.5	661	1,087	1,445
Additional weight per 10 mm stroke	15.5	24	40	44

Max. lateral force F_q as a function of projection l

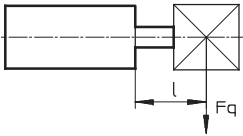

Basic version

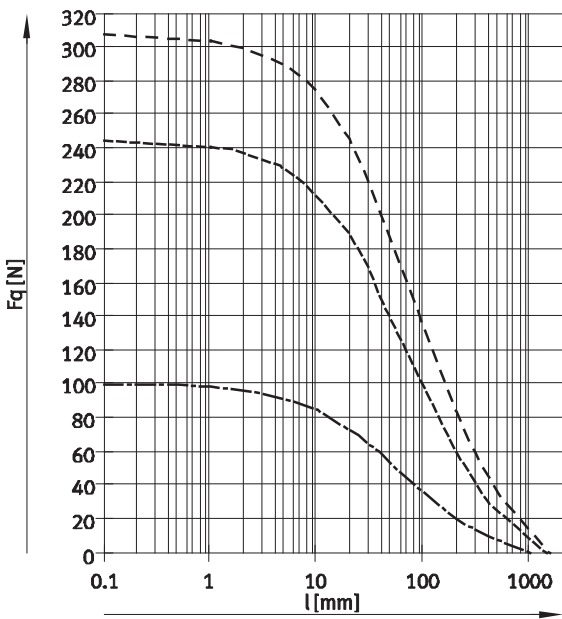

S2 – Through piston rod

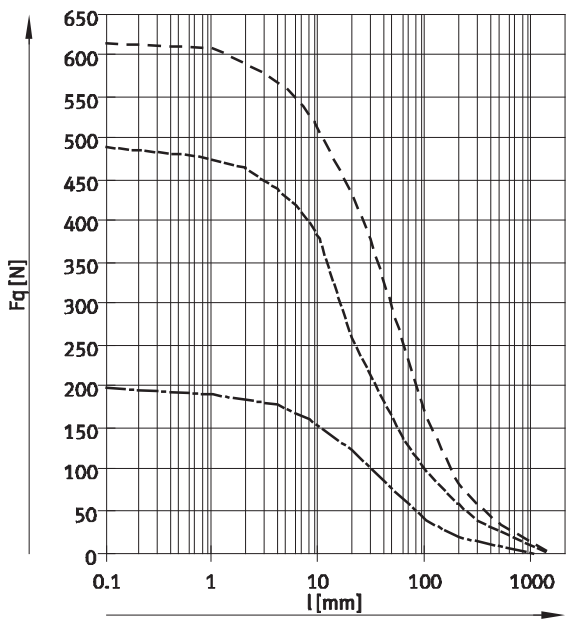

- \varnothing 32
- \varnothing 40
- \varnothing 50/63

Materials

Sectional view

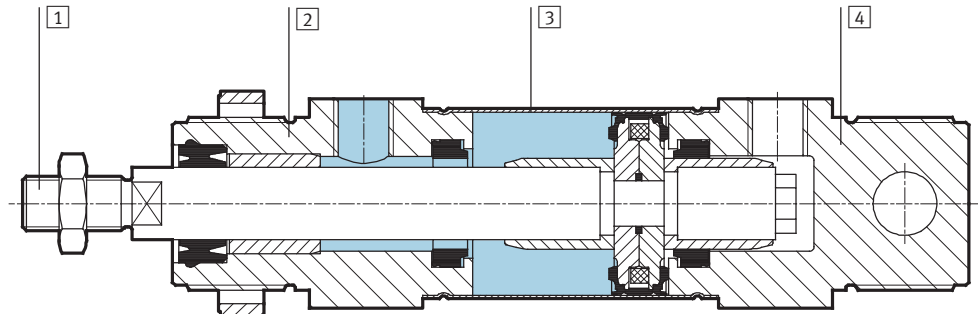

Round cylinder	Basic version	S6	S10	S11	R3
1 Piston rod	High-alloy steel				High-alloy stainless steel
2 Bearing cap	Anodised aluminium				
3 Cylinder barrel	High-alloy stainless steel				
4 End cap	Anodised aluminium				
– Seals	Polyurethane, nitrile rubber	Fluoro rubber	Fluoro rubber, polyurethane		Polyurethane, nitrile rubber
Note on materials	RoHS compliant				

Round cylinders DSNU

Technical data

FESTO

Dimensions

Download CAD data → www.festo.com

Basic version

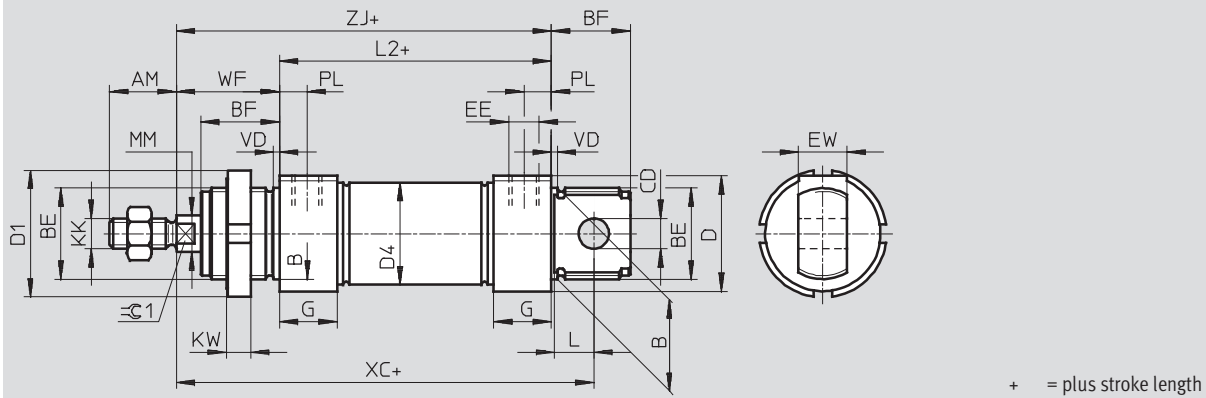

∅	AM	B	BE	BF	CD	D	D1	D4	EE	EW	G
[mm]		∅ h9			∅ E10	∅	∅	∅			
32	22	30	M30x1.5	26	10	38	42	33.6	G $\frac{1}{8}$	16	19
40	24	38	M38x1.5	30	12	46	50	41.6	G $\frac{1}{4}$	18	25
50	32	45	M45x1.5	33	16	57	60	52.4		21	
63						70		65.4	G $\frac{3}{8}$	28	

∅	KK	KW	L	L2	MM	PL	VD	WF	XC	ZJ	∅C1	
[mm]					∅				±1			
32	M10x1.25	8	13	69.5	12	9	2	34	117.5	103.5	10	
40	M12x1.25		15	84.6	16	12		3	39	139.6	123.6	13
50	M16x1.5	10	16	86.2	20		13		44	147.2	130.2	17
63				94.2					45	156.2	139.2	

Round cylinders DSNU

Technical data

FESTO

Dimensions

Download CAD data → www.festo.com

MQ – Lateral air connection

MA – Axial air connection

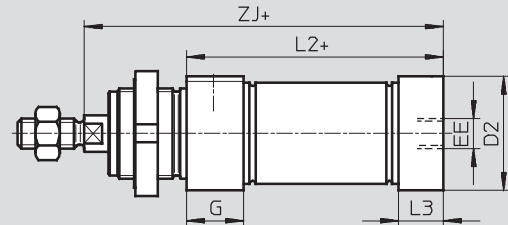
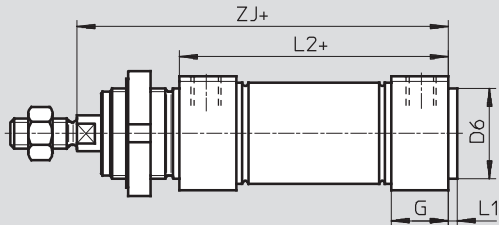

MH – Direct mounting

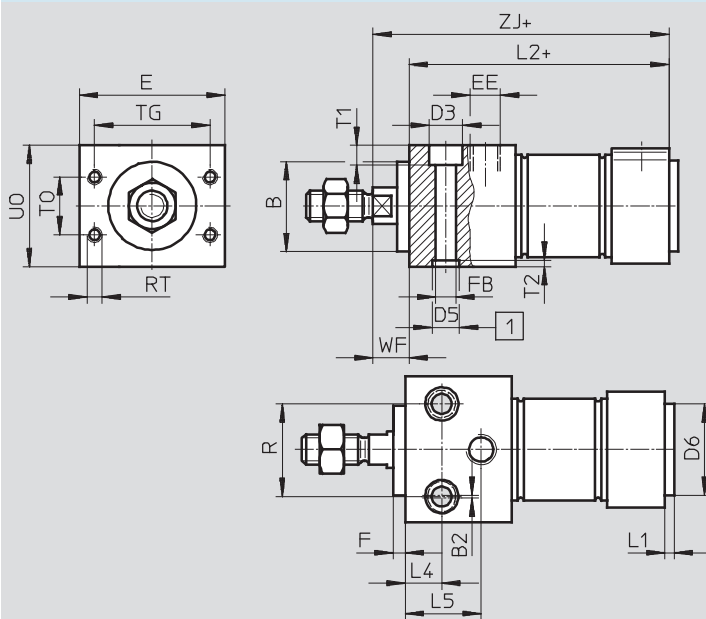

- 1 Centring holes
(2 centring sleeves included in scope of delivery)
- + = plus stroke length

∅ [mm]	B ∅ h9	B2	E	EE	G	F	FB ∅	D2 ∅	D3	D5 ∅	D6 ∅	L1	L2		
													-MQ	-MA	-MH
32	30	1	48	G ¹ / ₈	19	4	6.6	34	11	9	30	3	69.5	65.5	85.5
40	38		54	G ¹ / ₄	25		9	42	14	12	38	4	84.6	77.6	104.6
50	45	2	64	G ³ / ₈	28	4	11	66	18	15	45		4	86.2	86.2
63			72									94.2		94.2	117.2

∅ [mm]	L3	L4	L5	R	RT	T0	T1	T2	TG	U0	WF	ZJ		
												-MQ	-MA	-MH
32	15	12	25	30	M5	19	6.6	2.1	38	40	12	103.5	99.5	97.5
40	18	15	32	38		24	9	2.6	42	48		123.6	116.5	116.6
50	25		35	42	M6	32	11	3.1	50	58	15	130.2	130.2	124.2
63	28	36	44	M8	36	139.2						139.2	132.2	

Round cylinders DSNU

Technical data



Dimensions

Download CAD data → www.festo.com

S2 – Through piston rod

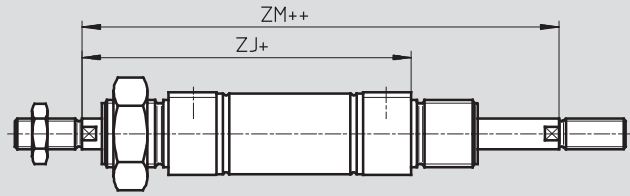

- - Note

The thread types at both piston rod ends are identical. In combination with variant Q, the left-hand piston rod end is square, the right-hand piston rod end round.

+ = plus stroke length
++ = plus 2x stroke length

K2 – Extended male piston rod thread

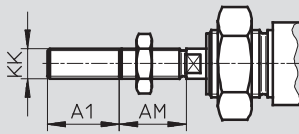

K6 – Shortened male piston rod thread

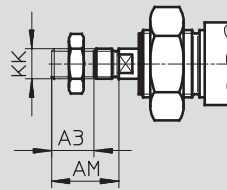

K3 – Female piston rod thread

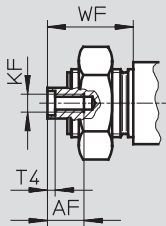

K5 – Special piston rod thread

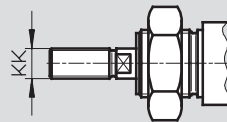

K8 – Extended piston rod

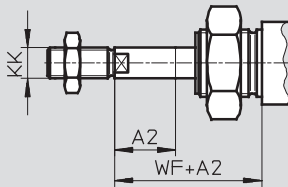

- - Note

If variant K8 is required in combination with S2, the piston rod will only be extended on one side.

∅ [mm]	A1 max.	A2 max.	A3 max.	AF	AM	KF	KK		T4	WF	ZJ			ZM
							Basic thread	Special thread ¹⁾			-MQ	-MA	-MH	
32	35	500	8	12	22	M6	M10x1.25	M10	2.6	34	103.5	99.5	97.5	137.5
40					24	M8	M12x1.25	M12	3.3	39	123.6	111.6	116.6	162.6
50	70		10	16	32	M10	M16x1.5	M16	4.7	44	130.2	130.2	124.2	174.2
63										45	139.2	139.2	132.2	184.2

1) The special threads are only available as male threads. The scope of delivery does not include a hex nut for the piston rod thread

Round cylinders DSNU

Technical data

Ordering data								
Type	Piston Ø [mm]	Stroke [mm]	P – Flexible cushioning rings/ pads at both ends		PPV – Pneumatic cushioning, adjustable at both ends		PPS – Pneumatic cushioning, self-adjusting at both ends	
			A – With position sensing		A – With position sensing		A – With position sensing	
			Part No.	Type	Part No.	Type	Part No.	Type
	32	25	195 980	DSNU-32-25-P-A	196 020	DSNU-32-25-PPV-A	559 295	DSNU-32-25-PPS-A
		40	195 981	DSNU-32-40-P-A	196 021	DSNU-32-40-PPV-A	559 296	DSNU-32-40-PPS-A
		50	195 982	DSNU-32-50-P-A	196 022	DSNU-32-50-PPV-A	559 297	DSNU-32-50-PPS-A
		80	195 983	DSNU-32-80-P-A	196 023	DSNU-32-80-PPV-A	559 298	DSNU-32-80-PPS-A
		100	195 984	DSNU-32-100-P-A	196 024	DSNU-32-100-PPV-A	559 299	DSNU-32-100-PPS-A
		125	195 985	DSNU-32-125-P-A	196 025	DSNU-32-125-PPV-A	559 300	DSNU-32-125-PPS-A
		160	195 986	DSNU-32-160-P-A	196 026	DSNU-32-160-PPV-A	559 301	DSNU-32-160-PPS-A
		200	195 987	DSNU-32-200-P-A	196 027	DSNU-32-200-PPV-A	559 302	DSNU-32-200-PPS-A
		250	195 988	DSNU-32-250-P-A	196 028	DSNU-32-250-PPV-A	559 303	DSNU-32-250-PPS-A
	320	195 989	DSNU-32-320-P-A	196 029	DSNU-32-320-PPV-A	559 304	DSNU-32-320-PPS-A	
	40	25	195 990	DSNU-40-25-P-A	196 030	DSNU-40-25-PPV-A	559 305	DSNU-40-25-PPS-A
		40	195 991	DSNU-40-40-P-A	196 031	DSNU-40-40-PPV-A	559 306	DSNU-40-40-PPS-A
		50	195 992	DSNU-40-50-P-A	196 032	DSNU-40-50-PPV-A	559 307	DSNU-40-50-PPS-A
		80	195 993	DSNU-40-80-P-A	196 033	DSNU-40-80-PPV-A	559 308	DSNU-40-80-PPS-A
		100	195 994	DSNU-40-100-P-A	196 034	DSNU-40-100-PPV-A	559 309	DSNU-40-100-PPS-A
		125	195 995	DSNU-40-125-P-A	196 035	DSNU-40-125-PPV-A	559 310	DSNU-40-125-PPS-A
		160	195 996	DSNU-40-160-P-A	196 036	DSNU-40-160-PPV-A	559 311	DSNU-40-160-PPS-A
		200	195 997	DSNU-40-200-P-A	196 037	DSNU-40-200-PPV-A	559 312	DSNU-40-200-PPS-A
		250	195 998	DSNU-40-250-P-A	196 038	DSNU-40-250-PPV-A	559 313	DSNU-40-250-PPS-A
		320	195 999	DSNU-40-320-P-A	196 039	DSNU-40-320-PPV-A	559 314	DSNU-40-320-PPS-A
		50	25	196 000	DSNU-50-25-P-A	196 040	DSNU-50-25-PPV-A	559 315
	40		196 001	DSNU-50-40-P-A	196 041	DSNU-50-40-PPV-A	559 316	DSNU-50-40-PPS-A
	50		196 002	DSNU-50-50-P-A	196 042	DSNU-50-50-PPV-A	559 317	DSNU-50-50-PPS-A
	80		196 003	DSNU-50-80-P-A	196 043	DSNU-50-80-PPV-A	559 318	DSNU-50-80-PPS-A
	100		196 004	DSNU-50-100-P-A	196 044	DSNU-50-100-PPV-A	559 319	DSNU-50-100-PPS-A
	125		196 005	DSNU-50-125-P-A	196 045	DSNU-50-125-PPV-A	559 320	DSNU-50-125-PPS-A
	160		196 006	DSNU-50-160-P-A	196 046	DSNU-50-160-PPV-A	559 321	DSNU-50-160-PPS-A
	200		196 007	DSNU-50-200-P-A	196 047	DSNU-50-200-PPV-A	559 322	DSNU-50-200-PPS-A
	250		196 008	DSNU-50-250-P-A	196 048	DSNU-50-250-PPV-A	559 323	DSNU-50-250-PPS-A
	320	196 009	DSNU-50-320-P-A	196 049	DSNU-50-320-PPV-A	559 324	DSNU-50-320-PPS-A	
	63	25	196 010	DSNU-63-25-P-A	196 050	DSNU-63-25-PPV-A	559 325	DSNU-63-25-PPS-A
		40	196 011	DSNU-63-40-P-A	196 051	DSNU-63-40-PPV-A	559 326	DSNU-63-40-PPS-A
50		196 012	DSNU-63-50-P-A	196 052	DSNU-63-50-PPV-A	559 327	DSNU-63-50-PPS-A	
80		196 013	DSNU-63-80-P-A	196 053	DSNU-63-80-PPV-A	559 328	DSNU-63-80-PPS-A	
100		196 014	DSNU-63-100-P-A	196 054	DSNU-63-100-PPV-A	559 329	DSNU-63-100-PPS-A	
125		196 015	DSNU-63-125-P-A	196 055	DSNU-63-125-PPV-A	559 330	DSNU-63-125-PPS-A	
160		196 016	DSNU-63-160-P-A	196 056	DSNU-63-160-PPV-A	559 331	DSNU-63-160-PPS-A	
200		196 017	DSNU-63-200-P-A	196 057	DSNU-63-200-PPV-A	559 332	DSNU-63-200-PPS-A	
250		196 018	DSNU-63-250-P-A	196 058	DSNU-63-250-PPV-A	559 333	DSNU-63-250-PPS-A	
320		196 019	DSNU-63-320-P-A	196 059	DSNU-63-320-PPV-A	559 334	DSNU-63-320-PPS-A	

 Note

Variable strokes and additional variants can be configured and ordered through the DSNU modular product system → 26.

Round cylinders DSNU-Q, protected against rotation

FESTO

Technical data

Function

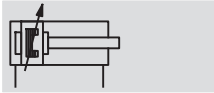
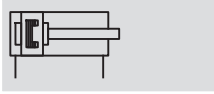

∅ - Diameter
32 ... 63 mm

— | — Stroke length
5 ... 500 mm



General technical data				
Piston ∅	32	40	50	63
Pneumatic connection	G $\frac{1}{8}$	G $\frac{1}{4}$	G $\frac{1}{4}$	G $\frac{3}{8}$
Piston rod thread	M10x1.25	M12x1.25	M16x1.5	M16x1.5
Operating medium	Filtered compressed air, lubricated or unlubricated			
Constructional design	Piston Protected against rotation with square piston rod			
Max. torque at the piston rod [Nm]	0.8	1.1	1.5	1.5
Cushioning	Flexible cushioning rings/pads at both ends Pneumatic cushioning, adjustable at both ends			
Cushioning length (PPV) [mm]	14	18	20	21
Position sensing	Via proximity sensor			
Type of mounting	Via accessories			
Mounting position	Any			

Operating conditions				
Piston ∅	32	40	50	63
Operating medium	Compressed air in accordance with ISO 8573-1:2010 [7:4:4]			
Note on operating/ pilot medium	Operation with lubricated medium possible (in which case lubricated operation will always be required)			
Operating pressure [bar]	1 ... 10			

Ambient conditions		
Round cylinder	Basic version	R3
Ambient temperature ¹⁾ [°C]	-20 ... +80	
Corrosion resistance class CRC ²⁾	2	3

1) Note operating range of proximity sensors

2) Corrosion resistance class 2 as per Festo standard 940 070

Components subject to moderate corrosion stress. Externally visible parts with primarily decorative surface requirements which are in direct contact with a normal industrial environment or media such as coolants or lubricating agents.

Corrosion resistance class 3 as per Festo standard 940 070

Components requiring higher corrosion resistance. External visible parts in direct contact with industrial atmospheres or media such as solvents and cleaning agents, with a predominantly functional requirement for the surface.

Round cylinders DSNU-Q, protected against rotation

Technical data

Force [N] and impact energy [J]				
Piston Ø	32	40	50	63
Theoretical force at 6 bar, advancing	483	753	1,178	1,870
Theoretical force at 6 bar, retracting	415	633	990	1,682
Impact energy at the end positions	0.40	0.70	1	1.3

Weight [g]				
Piston Ø	32	40	50	63
Product weight with 0 mm stroke	370.5	661	1,087	1,445
Additional weight per 10 mm stroke	15.5	24	40	44

Materials

Sectional view

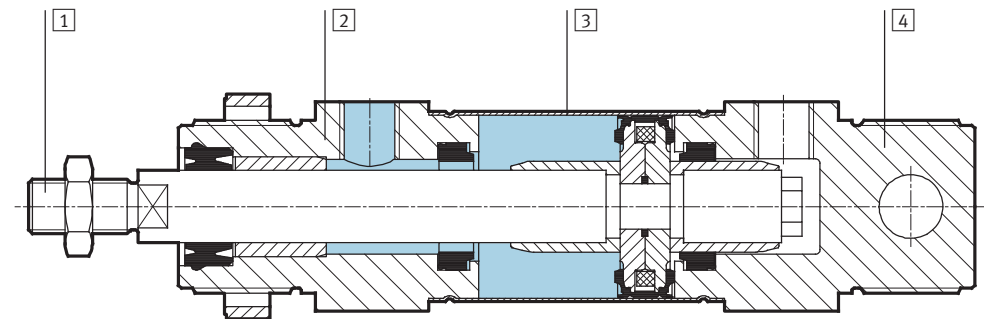

Round cylinder	Basic version	R3
1 Piston rod	High-alloy steel	High-alloy stainless steel
2 Bearing cap	Anodised aluminium	
3 Cylinder barrel	High-alloy stainless steel	
4 End cap	Anodised aluminium	
- Seals	Polyurethane, nitrile rubber	
Note on materials	RoHS compliant	

Round cylinders DSNU-Q, protected against rotation

Technical data

Dimensions Download CAD data → www.festo.com
 Basic version

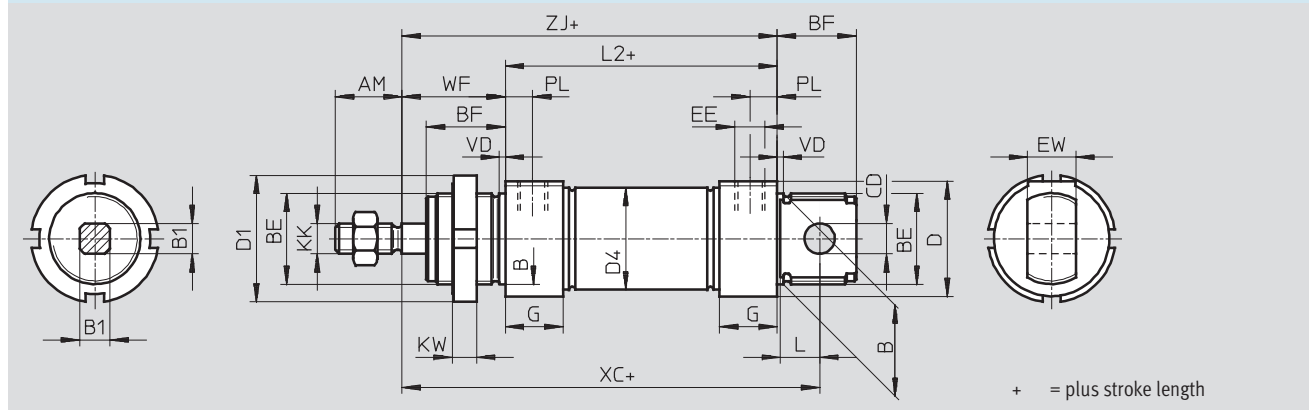

∅	AM	B	B1	BE	BF	CD	D	D1	D4	EE	EW
[mm]		∅ h9	□			∅ E10	∅	∅	∅		
32	22	30	10	M30x1.5	26	10	38	42	33.6	G1/8	16
40	24	38	12	M38x1.5	30	12	46	50	41.6	G1/4	18
50	32	45	16	M45x1.5	33	16	57	60	52.4	G1/4	21
63	32	45	16	M45x1.5	33	16	70	60	65.4	G3/8	21

∅	G	KK	KW	L	L2	PL	VD	WF	XC	ZJ
[mm]									±1	
32	19	M10x1.25	8	13	69.5	9	2	34	117.5	103.5
40	25	M12x1.25	10	15	84.6	12	3	39	139.6	123.6
50	25	M16x1.5	10	16	86.2	12	3	44	147.2	130.2
63	28	M16x1.5	10	16	94.2	13	3	45	156.2	139.2

Round cylinders DSNU-KP, with clamping unit

Technical data

Function

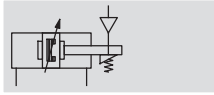
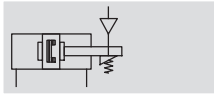

- \varnothing - Diameter
32 ... 63 mm

- | - Stroke length
1 ... 500 mm

-  - Note

Additional measures are required for use in safety-related applications; in Europe, for example, the standards listed under the EC Machinery Directive must be observed. Without additional measures in accordance with statutory minimum requirements, the product is not suitable for use in safety-related sections of control systems.



General technical data		32	40	50	63
Piston \varnothing		32	40	50	63
Pneumatic connection		G $\frac{1}{8}$	G $\frac{1}{4}$	G $\frac{1}{4}$	G $\frac{3}{8}$
Piston rod thread		M10x1.25	M12x1.25	M16x1.5	M16x1.5
Constructional design		Piston			
		Piston rod			
		Cylinder barrel			
Cushioning	P	Flexible cushioning rings/pads at both ends			
	PPV	Pneumatic cushioning, adjustable at both ends			
	PPS	Cushioning, self-adjusting at both ends			
Cushioning length	PPV [mm]	14	18	20	21
	PPS [mm]	14	18	20	21
Position sensing		Via proximity sensor			
Type of mounting		Via through-holes			
		Via accessories			
Mounting position		Any			
Clamping unit holding force [N]		600	1,000	1,400	2,000
Axial play under load [mm]		0.5		0.8	
Clamping unit pneumatic connection		M5	G $\frac{1}{8}$	G $\frac{1}{8}$	G $\frac{1}{8}$

Operating conditions		32	40	50	63
Piston \varnothing		32	40	50	63
Operating medium		Compressed air in accordance with ISO 8573-1:2010 [7:4:4]			
Note on operating/pilot medium		Operation with lubricated medium possible (in which case lubricated operation will always be required)			
Operating pressure [bar]		3 ... 10			

Ambient conditions		Basic version	R3
Round cylinder		Basic version	R3
Ambient temperature ¹⁾ [°C]		-10 ... +80	
Corrosion resistance class CRC ²⁾		2	3

1) Note operating range of proximity sensors

2) Corrosion resistance class 2 as per Festo standard 940 070

Components subject to moderate corrosion stress. Externally visible parts with primarily decorative surface requirements which are in direct contact with a normal industrial environment or media such as coolants or lubricating agents.

Corrosion resistance class 3 as per Festo standard 940 070

Components requiring higher corrosion resistance. External visible parts in direct contact with industrial atmospheres or media such as solvents and cleaning agents, with a predominantly functional requirement for the surface.

Round cylinders DSNU-KP, with clamping unit

Technical data

FESTO

Force [N] and impact energy [J]				
Piston Ø	32	40	50	63
Theoretical force at 6 bar, advancing	483	753	1,178	1,870
Theoretical force at 6 bar, retracting	415	633	990	1,682
Impact energy at the end positions ¹⁾	0.40	0.70	1	1.3

1) The values are reduced by approx. 50% at an ambient temperature of 80 °C.

Mean piston velocity v as a function of applied load m in combination with PPS cushioning

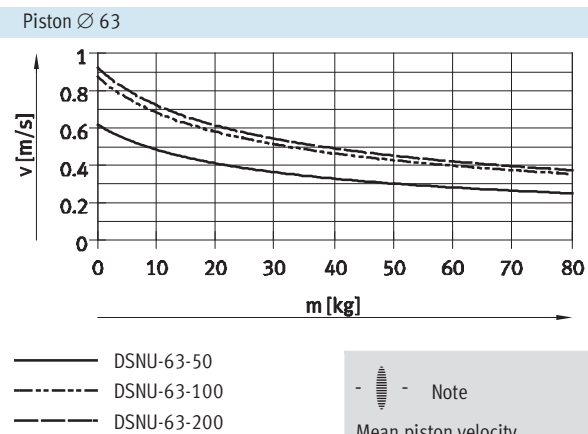
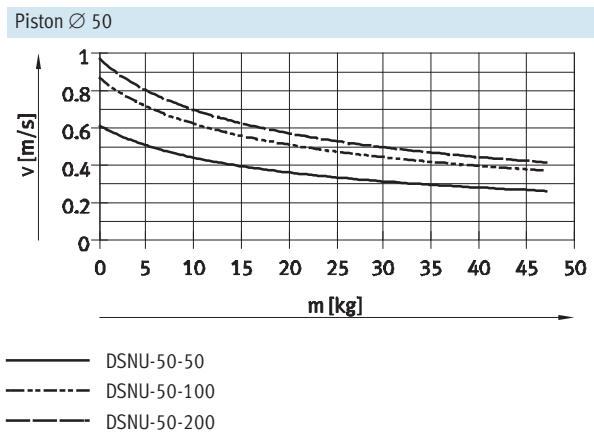
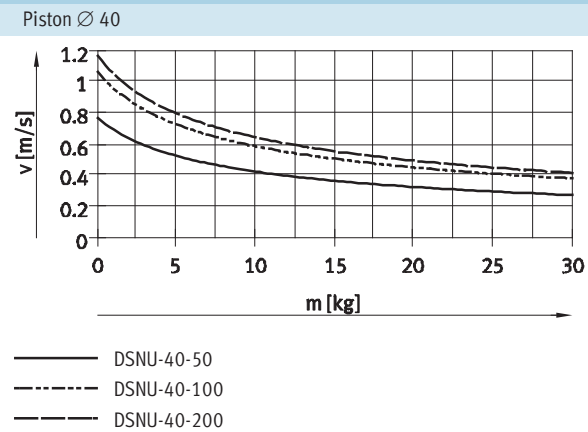
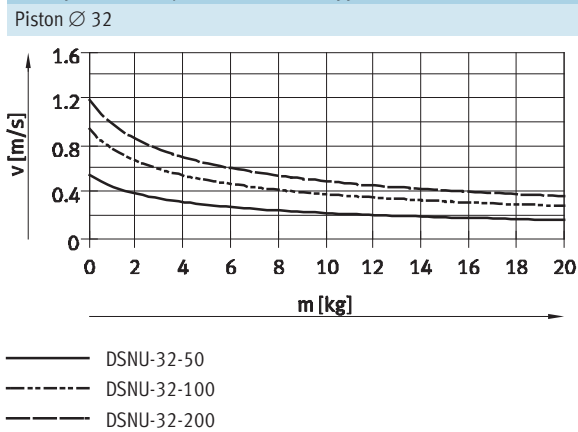

- - Note
Mean piston velocity
= stroke/movement time

- - Note

Design software for P cushioning → ProDrive	Additional graphs for PPS cushioning → www.festo.com	Design software for PPV cushioning → ProDrive
---	---	---

Weight [g]				
Piston Ø	32	40	50	63
Product weight with 0 mm stroke	711.5	1,287	2,059	2,556
Additional weight per 10 mm stroke	15.5	24	40	44

Round cylinders DSNU-KP, with clamping unit

Technical data

Max. lateral force F_q as a function of projection l

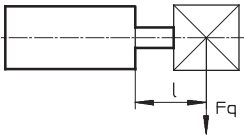

Basic version

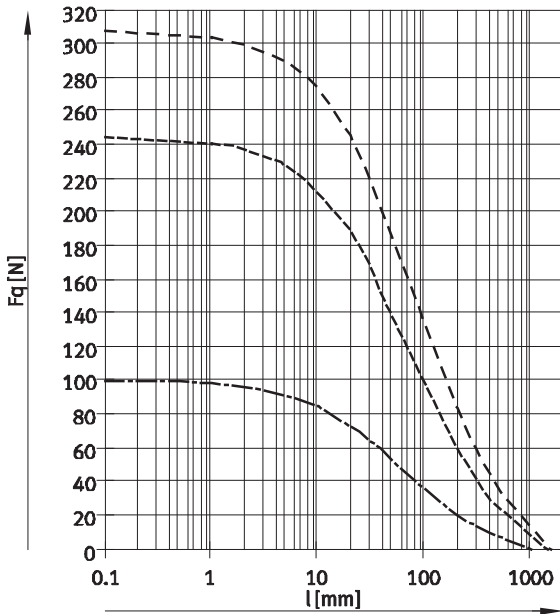

S2 – Through piston rod

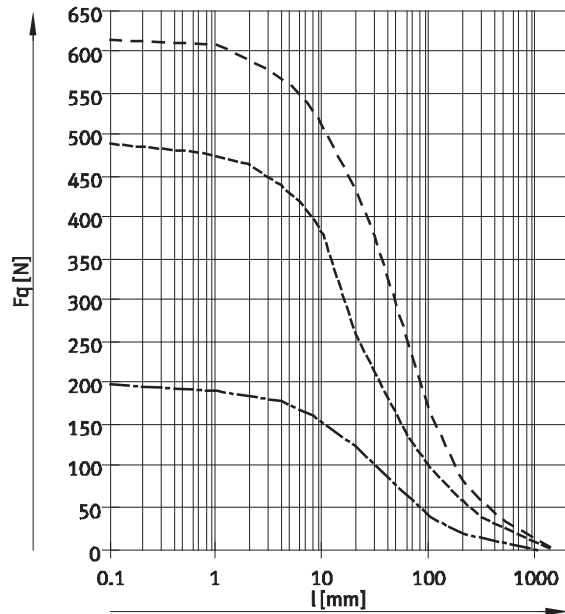

- $\varnothing 32$
- $\varnothing 40$
- $\varnothing 50/63$

Materials

Sectional view

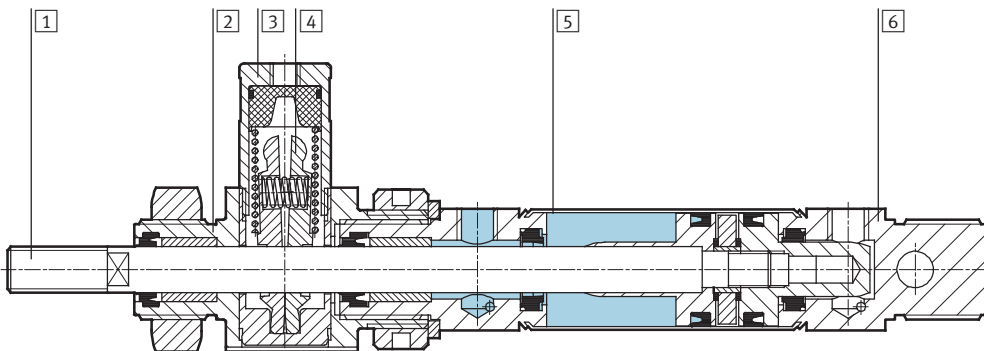

Round cylinder	Basic version	R3
1 Piston rod	High-alloy steel	High-alloy stainless steel
2 Bearing cap	Anodised aluminium	
3 Housing, clamping unit	Wrought aluminium alloy	
4 Clamping jaws	Brass	
5 Cylinder barrel	High-alloy stainless steel	
6 End cap	Anodised aluminium	
- Piston, clamping unit	Polyacetate	
- Spring	Spring steel	
- Seals	Polyurethane, nitrile rubber	
Note on materials	RoHS compliant	

Round cylinders DSNU-KP, with clamping unit

Technical data

FESTO

Dimensions

Download CAD data → www.festo.com

Basic version

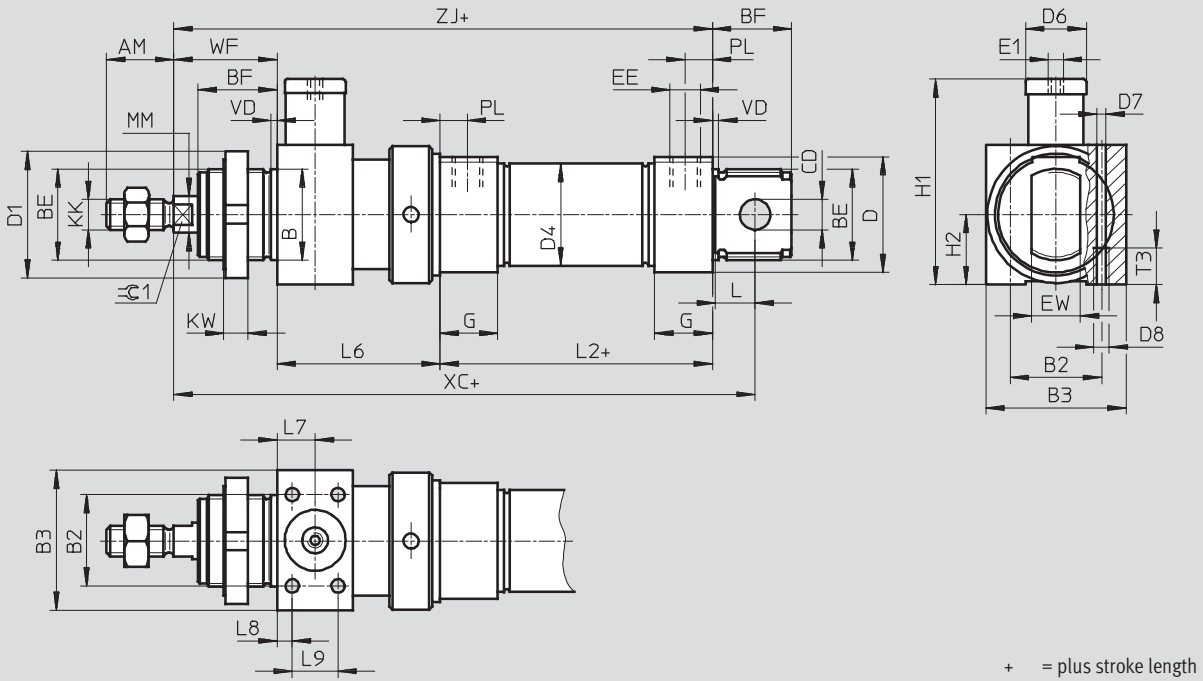

S2 – Through piston rod

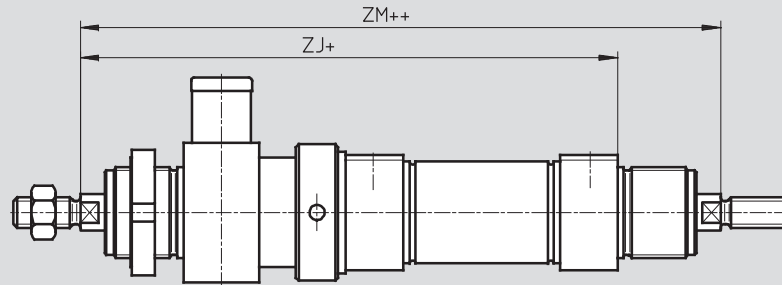

-  - Note

The thread types at both piston rod ends are identical. The clamping unit is mounted on only one side.

In combination with variant Q, the right-hand piston rod is square, the left-hand piston rod round.

The clamping unit is mounted on the left-hand, round piston rod.

+ = plus stroke length

++ = plus 2x stroke length

Round cylinders DSNU-KP, with clamping unit

Technical data

∅ [mm]	AM	B ∅ h9	B2	B3	BE	BF	CD ∅ E10	D ∅	D1 ∅	D4 ∅	D6	D7
32	22	30	30	46	M30x1.5	26	10	38	42	33.6	20	4.4
40	24	38	36	56	M38x1.5	30	12	46	50	41.6	24	6.8
50	32	45	50	65	M45x1.5	33	16	57	60	52.4	30	8.5
63			54	72	M45x1.5			70		65.4	38	

∅ [mm]	D8	E1	EE	EW	G	H1	H2	KK	KW	MM ∅	L	L2
32	M5	M5	G $\frac{1}{8}$	16	19	67.5	23	M10x1.25	8	12	13	69.5
40	M8	G $\frac{1}{8}$	G $\frac{1}{4}$	18	25	89	28	M12x1.25	10	16	15	84.6
50	M10	G $\frac{1}{8}$		21		107.5	32.5	M16x1.5		20	16	86.2
63		G $\frac{1}{8}$	G $\frac{3}{8}$		28	121.5	36		94.2			

∅ [mm]	L6 ±0.75	L7	L8	L9	T3	PL	VD	WF	XC ±1	ZJ	ZM	≈±1
32	55	12.5	5	15	12	9	2	34.5	173	159	191	10
40	69	17	7	20	18	12	3	40.5	210.1	194.1	230.1	13
50	78	20		26	20			45.5	226.7	209.7	250.7	17
63	86	24	8	32	21	13		46.5	243.7	226.7	268.7	

Round cylinders DSNU

Ordering data – Modular products

M Mandatory data					O Options →			
Module No.	Function	Piston Ø	Stroke	Cushioning	Position sensing	Cylinder end cap	Type of piston rod	Extended male thread
193 992	DSNU	32	1 ... 500	P	A	MQ	S2	...K2
193 993		40		PPV		MA		
193 994		50		PPS		MH		
193 995		63						
Order example								
193 994	DSNU	50	400	PPV	A	MQ		

Ordering table								
Size	32	40	50	63	Condi- tions	Code	Enter code	
M Module No.	193 992	193 993	193 994	193 995				
Function	Double-acting round cylinder						DSNU	DSNU
Piston Ø [mm]	32	40	50	63		-...		
Stroke [mm]	1 ... 500					-...		
Cushioning	Flexible cushioning rings/pads at both ends					-P		
	Pneumatic cushioning, adjustable at both ends				1	-PPV		
	Pneumatic cushioning, self-adjusting at both ends				15	-PPS		
O Position sensing	Via proximity sensor				2	-A		
Cylinder end cap	Lateral air connection, end cap				3	-MQ		
	Axial air connection, end cap				4	-MA		
	Mounting flange at front (direct mounting), bearing cap				5	-MH		
Type of piston rod	Through piston rod				6	-S2		
Extended male thread [mm]	Piston rod with extended male thread				7	-...K2		
	1 ... 35	1 ... 70						

- | | | | |
|--------------|---------------------------|---------------|---|
| 1 PPV | Not with MA | 5 MH | Not with combination S6-R3 |
| 2 A | Minimum stroke: 10 mm | | Not with KP, S10, S11, R8 |
| 3 MQ | Not with S2, S10, S11 | 6 S2 | Not with MQ, MA, S10, S11 |
| 4 MA | Not with S2, S10, S11, R8 | 7 K2 | Not with K3, K6 |
| | | 15 PPS | Not with MA, MH, S6, S10, S11
and not with combination MQ-R3 |

 **Note**

The bellows kit DADB must not be used in combination with the variant MH.

The running characteristics change slightly when the bellows kit DADB is combined with the variant S10 or S11.

Transfer order code

DSNU - - - - - - - -

Round cylinders DSNU

Ordering data – Modular products

FESTO

→ <input type="checkbox"/> Options									
Shortened male thread	Female thread	Special thread	Extended piston rod	Clamping unit	Temperature resistance	Slow speed (constant motion)	Running characteristics	Corrosion protection	Wiper seal
...K6	K3	"..."K5	...K8	KP	S6	S10	S11	R3	R8
- 8K6	-	-	-	-	- S6	-	-	- R3	-

Ordering table										
Size	32	40	50	63	Condi- tions	Code	Enter code			
↓ Shortened male thread	Piston rod with shortened male thread				<input type="checkbox"/>	-...K6				
<input type="checkbox"/> [mm]	1 ... 8	1 ... 10								
Female thread	Piston rod with female thread				<input type="checkbox"/>	-K3				
	(M6)	(M8)	(M10)							
Special thread	Piston rod with special thread				<input type="checkbox"/>	-"..."K5				
	M10	M12	M16							
Piston rod extended at one end	Extended piston rod at one end				<input type="checkbox"/>	...K8				
[mm]	1 ... 500									
Clamping unit	Attached				<input type="checkbox"/>	-KP				
Temperature resistance	Heat-resistant seals for temperatures up to 120 °C				<input type="checkbox"/>	-S6				
Slow speed (constant motion)	Slow speed (constant motion at low piston speeds)				<input type="checkbox"/>	-S10				
Running characteristics	Low friction				<input type="checkbox"/>	-S11				
Corrosion protection	High corrosion protection				<input type="checkbox"/>	-R3				
Wiper seal	Metal wiper seal				<input type="checkbox"/>	-R8				

- K6** Not with K3
- K3** Not with K5
- KP** Not with S6, S10, S11, R3, R8

- S6** Not with S10, S11
- S10** Not with S11, R3, R8
- S11** Not with R3, R8
- R3** Not with R8

Transfer order code

- - - - - - - - - - -

Round cylinders DSNU-Q, protected against rotation

Ordering data – Modular products

M Mandatory data					O Options →				
Module No.	Function	Piston Ø	Stroke	Cushioning	Position sensing	Cylinder end cap	Protection against rotation	Type of piston rod	Extended male thread
193 992	DSNU	32	1 ... 500	P	A	MQ	Q	S2	...K2
193 993		40		PPV		MA			
193 994		50				MH			
193 995		63							
Order example									
193 992	DSNU	32	500	P	A	MA	Q		

Ordering table										
Size	32	40	50	63	Condi- tions	Code	Enter code			
M Module No.	193 992	193 993	193 994	193 995						
Function	Double-acting round cylinder						DSNU	DSNU		
Piston Ø [mm]	32	40	50	63		-...				
Stroke [mm]	1 ... 500					-...				
Cushioning	Flexible cushioning rings/pads at both ends					-P				
	Pneumatic cushioning, adjustable at both ends				1	-PPV				
O Position sensing	Via proximity sensor				2	-A				
Cylinder end cap	Lateral air connection, end cap				3	-MQ				
	Axial air connection, end cap				3	-MA				
	Mounting flange at front (direct mounting), bearing cap				4	-MH				
Protection against rotation	Square piston rod					-Q	-Q			
	Restricted stroke [mm]				5 ... 300	5 ... 400	5 ... 500			
Type of piston rod	Through piston rod					-S2				
Extended male thread	Piston rod with extended male thread									
	[mm]	1 ... 35		1 ... 70		5	-...K2			

- 1 PPV Not with MA
- 2 A Minimum stroke: 10 mm
- 3 MQ, MA Not with S2
- 4 MH Not with combinations: Q-R3, S6-R3
- 5 K2 Not with KP
- Not with K3, K6

 Note
The bellows kit DADB must not be used in combination with the variant Q.

Transfer order code

DSNU - - - - - - - - - -

Round cylinders DSNU-Q, protected against rotation

Ordering data – Modular products

→ 0 Options

Male thread shortened at one end	Female thread	Special thread	Extended piston rod	Clamping unit	Temperature resistance	Corrosion protection
...K6	K3	"..."K5	...K8	KP	S6	R3
-	- K3 -	-	-	- KP -	-	-

Ordering table							
Size	32	40	50	63	Condi-tions	Code	Enter code
↓ Shortened male thread	Piston rod with shortened male thread						
0 Shortened male thread [mm]	1 ... 8	1 ... 10			6	-...K6	
Female thread	Piston rod with female thread						
	(M6)	(M8)	(M10)		7	-K3	
Special thread	Piston rod with special thread						
	M10	M12	M16			"..."K5	
Piston rod extended at one end	Extended piston rod at one end						
[mm]	1 ... 500						...K8
Clamping unit	Attached				8	-KP	
Temperature resistance	Heat-resistant seals for temperatures up to 120 °C					-S6	
Corrosion protection	High corrosion protection					-R3	

6 **K6** Not with K3
 7 **K3** Not with K5

8 **KP** Only with S2
 Not with S6, R3

Transfer order code

- [] - [] - [] - [] - [] - [] - []

Round cylinders ESNU

Technical data

FESTO

Function

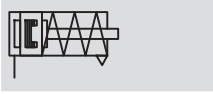

∅ - Diameter
32 ... 63 mm

l - Stroke length
1 ... 50 mm

Additional variants

→ 33



Basic version



Axial air connection MA

General technical data				
Piston ∅	32	40	50	63
Pneumatic connection	G $\frac{1}{8}$	G $\frac{1}{4}$	G $\frac{1}{4}$	G $\frac{3}{8}$
Piston rod thread	M10x1.25	M12x1.25	M16x1.5	M16x1.5
Constructional design	Piston			
	Piston rod			
	Cylinder barrel			
Cushioning	Flexible cushioning rings/pads at both ends			
Position sensing	Via proximity sensor			
Type of mounting	Via accessories			
Mounting position	Any			

Operating conditions				
Piston ∅	32	40	50	63
Operating medium	Compressed air in accordance with ISO 8573-1:2010 [7:4:4]			
Note on operating/ pilot medium	Operation with lubricated medium possible (in which case lubricated operation will always be required)			
Operating pressure [bar]	1.2 ... 10			

Ambient conditions		
Round cylinder		
Ambient temperature ¹⁾ [°C]	-20 ... +80	
Corrosion resistance class CRC ²⁾	2	

1) Note operating range of proximity sensors.

2) Corrosion resistance class 2 as per Festo standard 940 070

Components subject to moderate corrosion stress. Externally visible parts with primarily decorative surface requirements which are in direct contact with a normal industrial environment or media such as coolants or lubricating agents.

Round cylinders ESNU

Technical data

FESTO

Force [N] and impact energy [J]				
Piston Ø	32	40	50	63
Theoretical force at 6 bar, advancing	442	688	1,071	1,763
Spring return force 10 mm stroke	36	60	95	95
Spring return force 25 mm stroke	30	50	82	82
Spring return force 50 mm stroke	20	30	60	60
Impact energy at the end positions ¹⁾	0.40	0.70	1	1.3

1) The values are reduced by approx. 50% at an ambient temperature of 80 °C.

Weight ESNU-... [g]				
Piston Ø	32	40	50	63
Product weight with 0 mm stroke	370.5	661	1,087	1,445
Additional weight per 10 mm stroke	15.5	24	40	44

Weight ESNU-...-MA [g]				
Piston Ø	32	40	50	63
Product weight with 0 mm stroke	330	585	1,013	1,369
Additional weight per 10 mm stroke	15.5	24	40	44

Materials

Sectional view

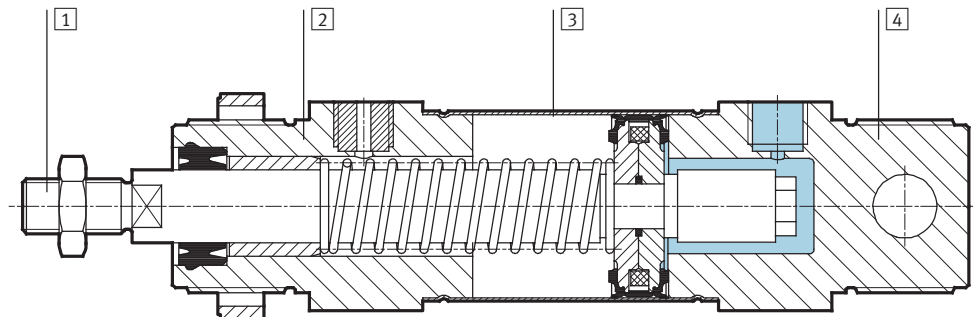

Round cylinder	
1	Piston rod High-alloy steel
2	Bearing cap Anodised aluminium
3	Cylinder barrel High-alloy stainless steel
4	End cap Anodised aluminium
-	Seals Polyurethane, nitrile rubber
-	Spring Spring steel
Note on materials RoHS compliant	

Round cylinders ESNU

Technical data

FESTO

Dimensions

Download CAD data → www.festo.com

Basic version

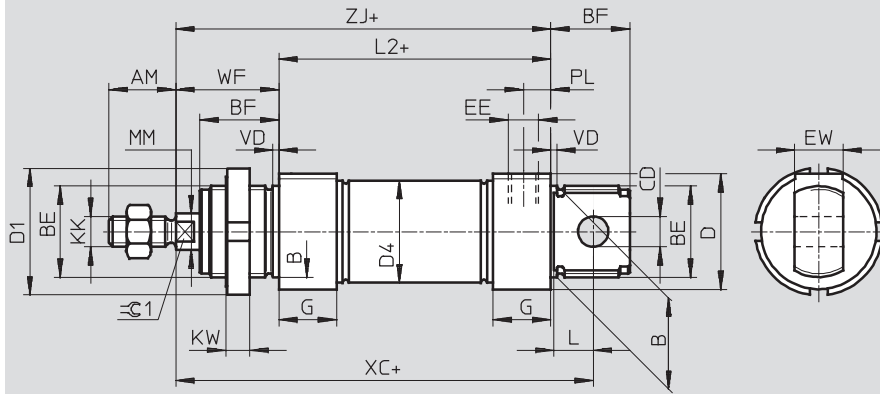

+ = plus stroke length

MA – Axial air connection

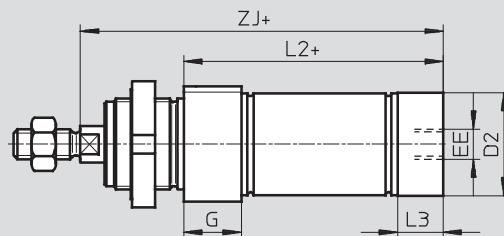

+ = plus stroke length

∅	AM	B	BE	BF	CD	D	D1	D2	D4	EE	EW	G	KK
[mm]		∅ h9			∅ E10	∅	∅	∅	∅				
32	22	30	M30x1.5	26	10	38	42	34	33.6	G $\frac{1}{8}$	16	19	M10x1.25
40	24	38	M38x1.5	30	12	46	50	42	41.6	G $\frac{1}{4}$	18	25	M12x1.25
50	32	45	M45x1.5	33	16	57	60	53	52.4				
63						70		66	65.4				

∅	KW	L	L2		L3	PL	MM	VD	WF	XC	ZJ		∅C1
[mm]				-MA			∅			±1		-MA	
32	8	13	69.5	65.5	15	9	12	2	34	117.5	103.5	99.5	10
40	10	15	84.6	77.6	18	12	16	3	39	139.6	123.6	116.6	13
50		16	86.2	86.2	25				44	147.2	130.2	130.2	17
63		94.2	94.2	28	13	45	156.2		139.2	139.2			

Round cylinders ESNU

Technical data

FESTO

Dimensions Download CAD data → www.festo.com

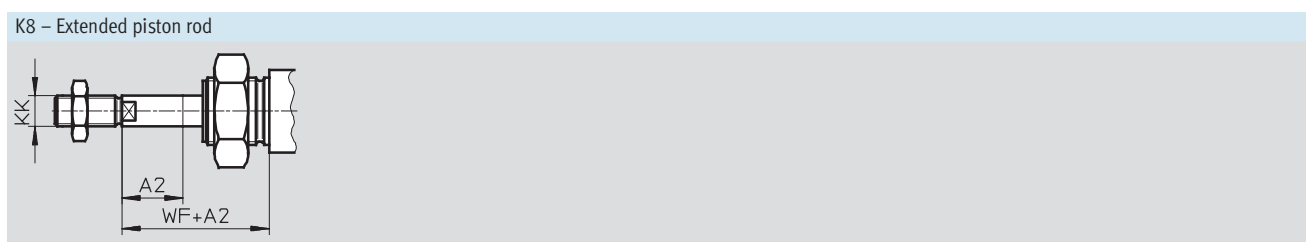
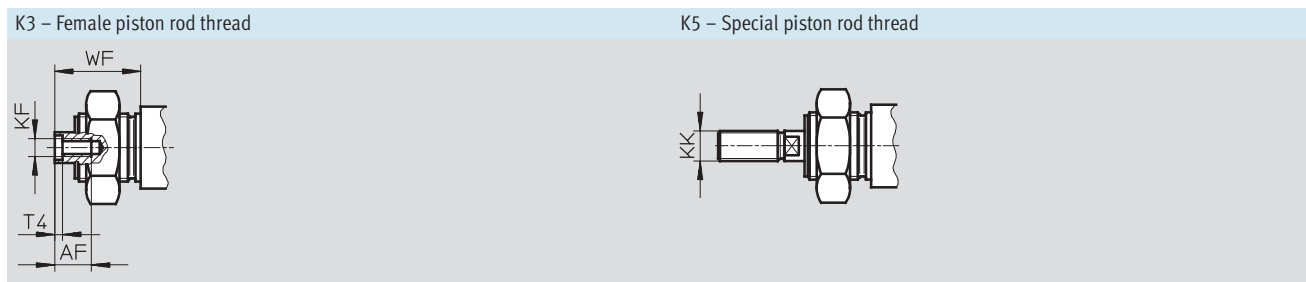
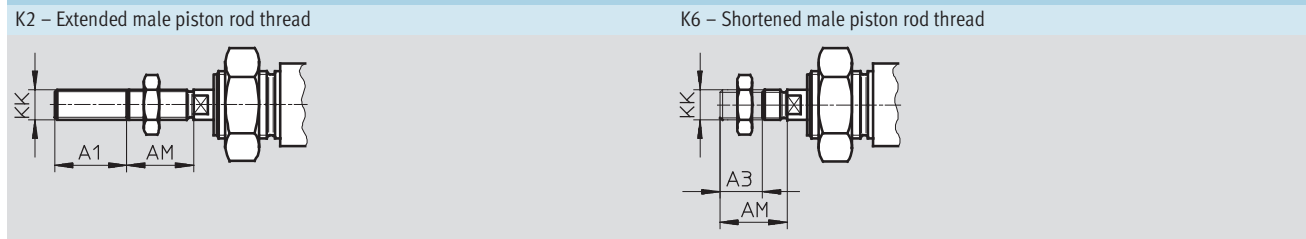

∅ [mm]	A1 max.	A2 max.	A3 max.	AF	AM	KF	KK		T4	WF
							Basic thread	Special thread ¹⁾		
32	35	50	8	12	22	M6	M10x1.25	M10	2.6	34
40						M8	M12x1.25	M12	3.3	39
50			10	16	32	M10	M16x1.5	M16	4.7	44
63										45

1) The special threads are only available as male threads. The scope of delivery does not include a hex nut for the piston rod thread.

Ordering data						
Type	Piston ∅ [mm]	Stroke [mm]	Without position sensing		With position sensing	
			Part No.	Type	Part No.	Type
	32	10	195 870	ESNU-32-10-P	196 376	ESNU-32-10-P-A
		25	195 871	ESNU-32-25-P	196 377	ESNU-32-25-P-A
		50	195 872	ESNU-32-50-P	196 378	ESNU-32-50-P-A
	40	10	195 873	ESNU-40-10-P	196 379	ESNU-40-10-P-A
		25	195 874	ESNU-40-25-P	196 380	ESNU-40-25-P-A
		50	195 875	ESNU-40-50-P	196 381	ESNU-40-50-P-A
	50	10	195 876	ESNU-50-10-P	196 382	ESNU-50-10-P-A
		25	195 877	ESNU-50-25-P	196 383	ESNU-50-25-P-A
		50	195 878	ESNU-50-50-P	196 384	ESNU-50-50-P-A
	63	10	195 879	ESNU-63-10-P	196 385	ESNU-63-10-P-A
		25	195 880	ESNU-63-25-P	196 386	ESNU-63-25-P-A
		50	195 881	ESNU-63-50-P	196 387	ESNU-63-50-P-A

Round cylinders ESNU

Ordering data – Modular products



M Mandatory data					O Options →	
Module No.	Function	Piston Ø	Stroke	Cushioning	Position sensing	End cap
194 002	ESNU	32	1 ... 50	P	A	MA
194 003		40				
194 004		50				
194 005		63				
Order example						
194 002	ESNU	- 32	- 45	- P	- A	- MA

Ordering table							
Size	32	40	50	63	Condi- tions	Code	Enter code
M Module No.	194 002	194 003	194 004	194 005			
Function	Single-acting round cylinder					ESNU	ESNU
Piston Ø [mm]	32	40	50	63		-...	
Stroke [mm]	1 ... 50					-...	
Cushioning	Flexible cushioning rings/pads at both ends					-P	-P
O Position sensing	Via proximity sensor				1	-A	
↓ End cap	Axial air connection					-MA	

1 A Minimum stroke: 10 mm

Transfer order code

Round cylinders ESNU

Ordering data – Modular products



0 Options				
Extended male thread	Shortened male thread	Female thread	Special thread	Extended piston rod
...K2	...K6	K3	"..."K5	...K8
50K2	-	-	"M10"K5	30K8

Ordering table							
Size	32	40	50	63	Condi- tions	Code	Enter code
↓							
0 Extended male thread [mm]	Piston rod with extended male thread 1 ... 35				2	-...K2	
Shortened male thread [mm]	Piston rod with shortened male thread 1 ... 8		1 ... 10			-...K6	
Female thread	Piston rod with female thread (M6) (M8) (M10)				3	-K3	
Special thread	Piston rod with special thread M10 M12 M16					-..."K5	
Extended piston rod [mm]	Extended piston rod 1 ... 50					...K8	

- 2 K2 Not with female thread K3, shortened male thread K6
- 3 K3 Not with special thread K5, shortened male thread K6

Transfer order code

- - - -

Round cylinders DSNU/ESNU

Accessories



Foot mounting HBN/CRH

Material:

HBN: Galvanised steel

CRH: High-alloy stainless steel

Free of copper and PTFE

RoHS-compliant

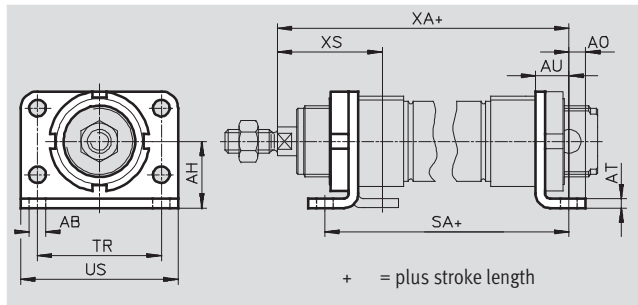

Dimensions and ordering data

For \varnothing [mm]	AB \varnothing	AH	AO	AT	AU	SA		TR	US	XA		XS	
							-KP				-KP		
32	7	28	7	4	14	97.5	151	52	66	117.5	171	44	-
40	9	33	10	5	20	124.6	192.1	60	80	138.6	206.1	49	-
50	9	40	10	6	20	126.2	202.7	70	90	150.2	226.7	58	-
63	9	45	10	6	20	134.2	218.7	76	96	159.2	243.7	59	-

For \varnothing [mm]	Basic version				High corrosion protection			
	CRC ¹⁾	Weight [g]	Part No.	Type	CRC ¹⁾	Weight [g]	Part No.	Type
32	2	247	195 851	HBN-32x2	4	237	162 951	CRH-32
40	2	446	195 852	HBN-40x2	4	341	162 952	CRH-40
50	2	666	195 853	HBN-50x2	4	559	162 953	CRH-50
63	2	816	195 854	HBN-63x2	4	680	162 954	CRH-63

Flange mounting FBN/CRFV

Material:

FBN: Galvanised steel

CRFV: High-alloy stainless steel

Free of copper and PTFE

RoHS-compliant

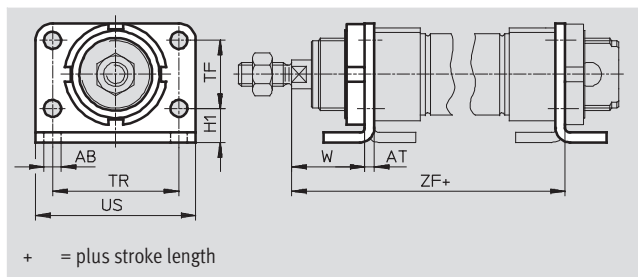

Dimensions and ordering data

For \varnothing [mm]	AB \varnothing	AT	H1	TF	TR	US	W	ZF	
									-KP
32	7	4	14	28	52	66	30	107.5	161
40	9	5	18	30	60	80	29	123.6	191.1
50	9	6	20	40	70	90	38	136.2	212.6
63	9	6	20	50	76	96	39	145.2	229.7

For \varnothing [mm]	Basic version				High corrosion protection			
	CRC ¹⁾	Weight [g]	Part No.	Type	CRC ¹⁾	Weight [g]	Part No.	Type
32	2	102	195 855	FBN-32	4	102	161 858	CRFV-32
40	2	190	195 856	FBN-40	4	190	161 859	CRFV-40
50	2	290	195 857	FBN-50	4	290	161 860	CRFV-50
63	2	365	195 858	FBN-63	4	365	161 861	CRFV-63

1) Corrosion resistance class 2 as per Festo standard 940 070

Components subject to moderate corrosion stress. Externally visible parts with primarily decorative surface requirements which are in direct contact with a normal industrial environment or media such as coolants or lubricating agents.

Corrosion resistance class 4 as per Festo standard 940 070

Components requiring higher corrosion resistance. Parts used with aggressive media, e.g. food or chemical industry. These applications should be supported with special tests with the media if required.

Round cylinders DSNU/ESNU

Accessories

Swivel mounting WBN

Material:
Galvanised steel
Free of copper and PTFE
RoHS-compliant
Cannot be used on the bearing cap in combination with bellows kit DADB.

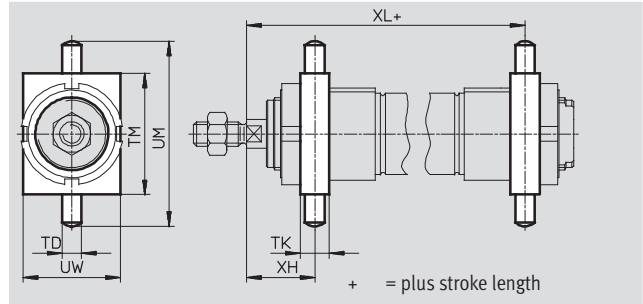

Dimensions and ordering data												
For \varnothing	TD	TK	TM	UM	UW	XH	XL		CRC ¹⁾	Weight	Part No.	Type
[mm]	\varnothing f8							-KP		[g]		
32	8	12	50	76	40	28	109.5	163	2	130	195 863	WBN-32
40	10	15	60	92	50	31.5	126.1	193.6	2	240	195 864	WBN-40
50	12	20	80	116	65	34	140.2	216.7	2	610	195 865	WBN-50/63
63	12	20	80	116	65	35	149.2	233.7	2	610	195 865	WBN-50/63

1) Corrosion resistance class 2 as per Festo standard 940 070
Components subject to moderate corrosion stress. Externally visible parts with primarily decorative surface requirements which are in direct contact with a surrounding industrial atmosphere or media such as cooling or lubricating agents.

Swivel mounting SBN

Material:
Mounting ring: Wrought aluminium alloy, anodised
Bearing: Bronze
Screws: Galvanised steel
Bracket: Steel
Cannot be used on the bearing cap in combination with bellows kit DADB.

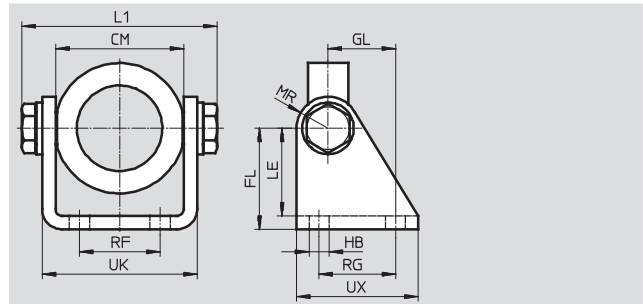
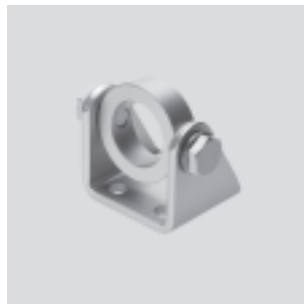

Dimensions and ordering data															
For \varnothing	CM	FL	GL	HB	L1	LE	MR	RF	RG	UK	UX	CRC ¹⁾	Weight	Part No.	Type
[mm]					max.								[g]		
32	46.1+0.2	40	27	9	72.2	35	13	28	30	56.1	50	2	295	539 924	SBN-32
40	57.1+0.2	45	30	9	88.2	39	14	36	34	69.1	54	2	465	539 925	SBN-40
50/63	70.1+0.4	50	34	9	102.2	44	16	42	35	82.1	65	2	670	539 926	SBN-50/63

1) Corrosion resistance class 2 as per Festo standard 940 070
Components subject to moderate corrosion stress. Externally visible parts with primarily decorative surface requirements which are in direct contact with a surrounding industrial atmosphere or media such as cooling or lubricating agents.

Round cylinders DSNU/ESNU

Accessories

FESTO

Clevis foot LBN/CRLBN

Material:

LBN: Galvanised steel

CRLBN: High-alloy stainless steel

Free of copper and PTFE

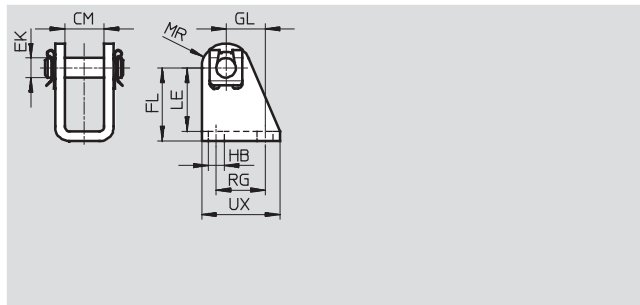

Dimensions and ordering data									
For Ø	CM	EK	FL	GL	HB	LE	MR	RG	UX
[mm]		Ø							
32	16.1	10	35 +0.4/-0.2	18.5	6.6	31	11	24	35
40	18.1	12	40 +0.4/-0.2	24.5	9	35	13	30	45
50, 63	21.1	16	45 +0.5/-0.2	28	9	39	14	34	50

For Ø	Basic version				High corrosion protection			
	CRC ¹⁾	Weight [g]	Part No.	Type	CRC ¹⁾	Weight [g]	Part No.	Type
32	2	109	195 860	LBN-32	4	107	195 866	CRLBN-32
40	2	192	195 861	LBN-40	4	184	195 867	CRLBN-40
50, 63	2	302	195 862	LBN-50/63	4	289	195 868	CRLBN-50/63

1) Corrosion resistance class 2 as per Festo standard 940 070

Components subject to moderate corrosion stress. Externally visible parts with primarily decorative surface requirements which are in direct contact with a normal industrial environment or media such as coolants or lubricating agents.

Corrosion resistance class 4 as per Festo standard 940 070





Components requiring higher corrosion resistance. Parts used with aggressive media, e.g. food or chemical industry. These applications should be supported with special tests with the media if required.



Ordering data – Mounting attachments				Technical data → Internet: clevis foot			
Designation	For Ø	Part No.	Type	Designation	For Ø	Part No.	Type
Clevis foot LBG				Right-angle clevis foot LQG			
	32	31 761	LBG-32		32	31 768	LQG-32
	40	31 762	LBG-40		40	31 769	LQG-40
	50	31 763	LBG-50		50	31 770	LQG-50
	63	31 764	LBG-63		63	31 771	LQG-63

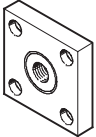
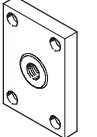

Round cylinders DSNU/ESNU

Accessories

FESTO

Ordering data – Piston rod attachments				Technical data → Internet: piston rod attachment			
Designation	For Ø	Part No.	Type	Designation	For Ø	Part No.	Type
Rod eye SGS				Rod clevis SGA			
	32	9 261	SGS-M10x1,25		32	32 954	SGA-M10x1,25
	40	9 262	SGS-M12x1,25		40	10 767	SGA-M12x1,25
	50	9 263	SGS-M16x1,5		50	10 768	SGA-M16x1,5
	63				63		
Rod clevis SG				Self-aligning rod coupler FK			
	32	6 144	SG-M10x1,25		32	6 140	FK-M10x1,25
	40	6 145	SG-M12x1,25		40	6 141	FK-M12x1,25
	50	6 146	SG-M16x1,5		50	6 142	FK-M16x1,5
	63				63		
Coupling piece KSG				Coupling piece KSZ			
	32	32 963	KSG-M10x1,25		32	36 125	KSZ-M10x1,25
	40	32 964	KSG-M12x1,25		40	36 126	KSZ-M12x1,25
	50	32 965	KSG-M16x1,5		50	36 127	KSZ-M16x1,5
	63				63		

Ordering data – Piston rod attachments, corrosion-resistant				Technical data → Internet: crsg			
Designation	For Ø	Part No.	Type	Designation	For Ø	Part No.	Type
Rod eye CRSGS				Rod clevis CRSG			
	32	195 582	CRSGS-M10x1,25		32	13 569	CRSG-M10x1,25
	40	195 583	CRSGS-M12x1,25		40	13 570	CRSG-M12x1,25
	50	195 584	CRSGS-M16x1,5		50	13 571	CRSG-M16x1,5
	63				63		

Ordering data – One-way flow control valves				Technical data → Internet: grl						
	Connection	For tubing O.D.	Material	Part No.	Type					
	Thread									
For exhaust air										
	G ¹ / ₈	3	Metal design	193 142	GRLA- ¹ / ₈ -QS-3-D					
		4			193 143 GRLA- ¹ / ₈ -QS-4-D					
		6			193 144 GRLA- ¹ / ₈ -QS-6-D					
		8			193 145 GRLA- ¹ / ₈ -QS-8-D					
	G ¹ / ₄	6			193 146 GRLA- ¹ / ₄ -QS-6-D					
		8			193 147 GRLA- ¹ / ₄ -QS-8-D					
		10			193 148 GRLA- ¹ / ₄ -QS-10-D					
	G ³ / ₈	6			193 149 GRLA- ³ / ₈ -QS-6-D					
		8			193 150 GRLA- ³ / ₈ -QS-8-D					
		10			193 151 GRLA- ³ / ₈ -QS-10-D					
	For supply air									
		G ¹ / ₈			3	Metal design	193 156	GRLZ- ¹ / ₈ -QS-3-D		
4			193 157 GRLZ- ¹ / ₈ -QS-4-D							
6			193 158 GRLZ- ¹ / ₈ -QS-6-D							
8			193 159 GRLZ- ¹ / ₈ -QS-8-D							

Ordering data – One-way flow control valves, corrosion-resistant				Technical data → Internet: crgla			
	Connection	For push-in fitting	Material	Part No.	Type		
	Thread						
For exhaust air							
	G ¹ / ₈	CRQS/CRQSL/CRQST	Electrolytically polished stainless steel casting	161 404	CRGRLA- ¹ / ₈ -B		
	G ¹ / ₄				161 405 CRGRLA- ¹ / ₄ -B		
	G ³ / ₈				161 406 CRGRLA- ³ / ₈ -B		

Round cylinders DSNU/ESNU

Accessories

FESTO

Bellows kit DADB



General technical data						
Type DADB-S1-		32	40	50	63	
Max. cylinder stroke range ¹⁾	DSNU [mm]	10 ... 500	10 ... 500	10 ... 500	10 ... 500	10 ... 500
	ESNU ²⁾ [mm]	10 ... 50	10 ... 50	10 ... 50	10 ... 50	10 ... 50
Type of mounting	Via threaded pin					
Mounting position	Any					
Resistance to media	Dust, chips, oil, grease, fuel (→ Internet: media resistance)					
Ambient temperature ³⁾	[°C]	-10 ... +80				
Protection class	IP54					
Corrosion resistance class CRC ⁴⁾	3					

1) In combination with the bellows kit DADB.

2) Slight change in the spring return force.

3) Note operating range of proximity sensors and cylinder.

4) Corrosion resistance class 3 as per Festo standard 940 070

Components with heavy corrosion exposure. Externally visible components in direct contact with normal industrial atmosphere or media such as solvents and cleaning agents, where the surface requirement is predominantly functional.

Materials

Sectional view

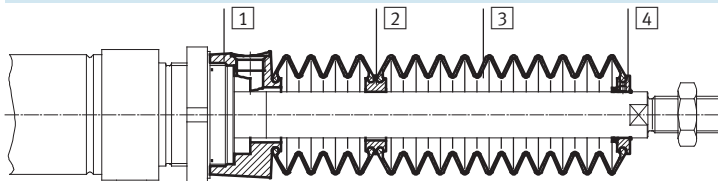

Bellows		
1	Connection	Polyamide
2	Intermediate piece	Polyamide
3	Bellows	Nitrile rubber
4	End piece	Polyamide
-	O-ring	Nitrile rubber
Note on materials		Free of copper and PTFE
		RoHS-compliant

Weight [g]				
Type DADB-S1- Stroke [mm]	32	40	50	63
10 ... 50	29	34	55	55
51 ... 125	41	49	75	75
126 ... 175	51	60	89	89
176 ... 250	66	78	113	113
251 ... 300	79	93	131	131
301 ... 350	92	108	149	149
351 ... 375	92	108	151	151
376 ... 425	104	122	169	169
426 ... 475	117	137	187	187
476 ... 500	117	137	189	189

Round cylinders DSNU/ESNU

Accessories

Travel velocity v as a function of tubing length l



The bellows kit is a leak-free system. To prevent unwanted media being drawn in, the supply and exhaust air must be ducted via a pressure compensation hole in the connection part

1. The pressure generated in the bellows kit by the positioning motion is primarily defined by travel velocity

and tubing length. The recommended tubing length based on the travel velocity of the drive can be read from the graph.

Advancing

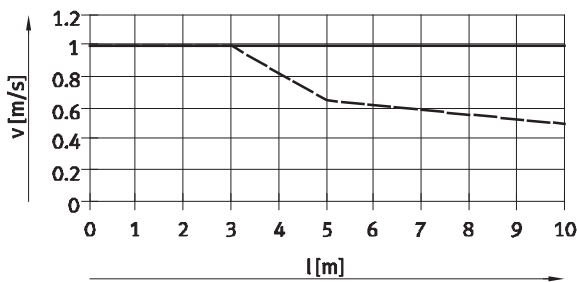

— Ø 32/50/63
- - - Ø 40

Returning

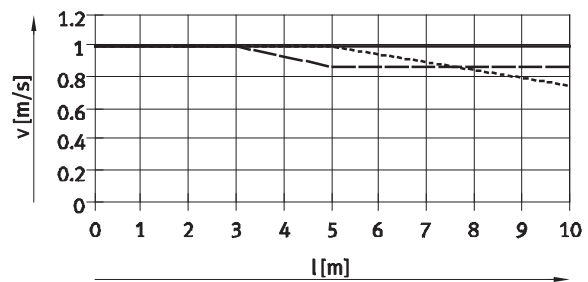

— Ø 32
- - - Ø 40
· · · · · Ø 50/63

Note

The push-in fittings opposite must be used for the pressure compensation hole.

Silencers can also be used as an alternative. This reduces the travel velocity slightly.

Tubing size and push-in fitting for pressure compensation hole

Ø [mm]	Tubing O.D. [mm]	Push-in fitting	
		Part No.	Type
32, 40	8	186 109	QS-G $\frac{1}{8}$ -8-I
		533 929	QS-F-G $\frac{1}{8}$ -8-I
		533 880	QS-F-G $\frac{1}{8}$ -8H
50, 63	12	186 350	QS-G $\frac{1}{4}$ -12
		533 848	QS-F-G $\frac{1}{4}$ -12
		533 884	QS-F-G $\frac{1}{4}$ -12H

Round cylinders DSNU/ESNU

Accessories

Dimensions

Download CAD data → www.festo.com

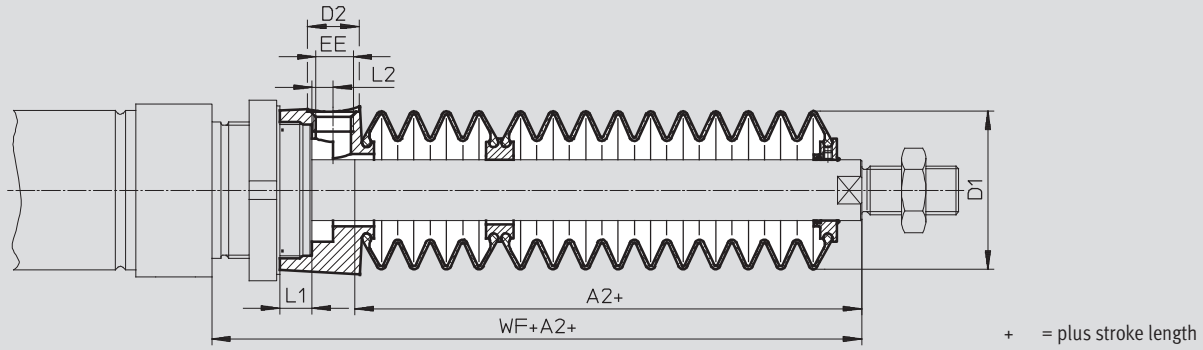

Ø Stroke [mm]	32							40						
	A2 ¹⁾	D1 max.	D2	EE	L1	L2	WF+A2	A2 ¹⁾	D1 max.	D2	EE	L1	L2	WF+A2
10 ... 50	30	38	14	G1/8	12.9	5.4	64	29	46	14	G1/8	8.1	5.4	68
51 ... 125	48						82	44						83
126 ... 175	63						97	57						96
176 ... 250	82						116	73						112
251 ... 300	97						131	87						126
301 ... 350	113						147	101						140
351 ... 375	115						149	102						141
376 ... 425	131						165	116						155
426 ... 475	147						181	131						170
476 ... 500	149						183	132						171

Ø Stroke [mm]	50/63						
	A2 ¹⁾	D1 max.	D2	EE	L1	L2	WF+A2
10 ... 50	30	57	17	G3/4	10.65	7	74/75
51 ... 125	48						92/93
126 ... 175	58						102/103
176 ... 250	77						121/122
251 ... 300	88						132/133
301 ... 350	99						143/144
351 ... 375	106						150/151
376 ... 425	117						161/162
426 ... 475	128						172/173
476 ... 500	135						179/180

1) The dimension corresponds to the K8 value (extended piston rod) of the drive

Round cylinders DSNU/ESNU

Accessories

Ordering data – Bellows kit

An extended piston rod (order code K8) is absolutely necessary when using a bellows kit. → Ordering data – Modular products.

The necessary dimension for K8 as a function of piston diameter and cylinder stroke as well as the associated bellows kit is indicated in the following table:

Order example:

Selected standard cylinder:

DSNU-32-320-PPV-A-MQ-...

Dimension for the corresponding K8 value (see table):
113 mm

Complete type designation for the standard cylinder:

DSNU-32-320-PPV-A-MQ-...-113K8

Associated bellows kit:

DADB-S1-32-S301-350

Cylinder data			Bellows kit		Cylinder data			Bellows kit	
∅	Stroke	Dimension for K8	Part No.	Type	∅	Stroke	Dimension for K8	Part No.	Type
[mm]	[mm]	[mm]			[mm]	[mm]	[mm]		
32	10 ... 50	30	553 441	DADB-S1-32-S10-50	40	10 ... 50	29	553 461	DADB-S1-40-S10-50
	51 ... 125	48	553 443	DADB-S1-32-S51-125		51 ... 125	44	553 463	DADB-S1-40-S51-125
	126 ... 175	63	553 445	DADB-S1-32-S126-175		126 ... 175	57	553 465	DADB-S1-40-S126-175
	176 ... 250	82	553 447	DADB-S1-32-S176-250		176 ... 250	73	553 467	DADB-S1-40-S176-250
	251 ... 300	97	553 449	DADB-S1-32-S251-300		251 ... 300	87	553 469	DADB-S1-40-S251-300
	301 ... 350	113	553 451	DADB-S1-32-S301-350		301 ... 350	101	553 471	DADB-S1-40-S301-350
	351 ... 375	115	553 453	DADB-S1-32-S351-375		351 ... 375	102	553 473	DADB-S1-40-S351-375
	376 ... 425	131	553 455	DADB-S1-32-S376-425		376 ... 425	116	553 475	DADB-S1-40-S376-425
	426 ... 475	147	553 457	DADB-S1-32-S426-475		426 ... 475	131	553 477	DADB-S1-40-S426-475
	476 ... 500	149	553 459	DADB-S1-32-S476-500		476 ... 500	132	553 479	DADB-S1-40-S476-500
50	10 ... 50	30	553 481	DADB-S1-50-S10-50	63	10 ... 50	30	553 501	DADB-S1-63-S10-50
	51 ... 125	48	553 483	DADB-S1-50-S51-125		51 ... 125	48	553 503	DADB-S1-63-S51-125
	126 ... 175	58	553 485	DADB-S1-50-S126-175		126 ... 175	58	553 505	DADB-S1-63-S126-175
	176 ... 250	77	553 487	DADB-S1-50-S176-250		176 ... 250	77	553 507	DADB-S1-63-S176-250
	251 ... 300	88	553 489	DADB-S1-50-S251-300		251 ... 300	88	553 509	DADB-S1-63-S251-300
	301 ... 350	99	553 491	DADB-S1-50-S301-350		301 ... 350	99	553 511	DADB-S1-63-S301-350
	351 ... 375	106	553 493	DADB-S1-50-S351-375		351 ... 375	106	553 513	DADB-S1-63-S351-375
	376 ... 425	117	553 495	DADB-S1-50-S376-425		376 ... 425	117	553 515	DADB-S1-63-S376-425
	426 ... 475	128	553 497	DADB-S1-50-S426-475		426 ... 475	128	553 517	DADB-S1-63-S426-475
	476 ... 500	135	553 499	DADB-S1-50-S476-500		476 ... 500	135	553 519	DADB-S1-63-S476-500

Round cylinders DSNU/ESNU

Accessories

FESTO

Ordering data – Proximity sensors, round design, magneto-resistive							Technical data → Internet: smto	
	Assembly	Switching output	Electrical connection		Cable length [m]	Connection direction	Part No.	Type
			Cable	Plug M8				
N/O contact								
	Via accessories	PNP	3-wire	–	2.5	In-line	152 836	SMTO-4U-PS-K-LED-24
			–	3-pin	–	In-line	152 742	SMTO-4U-PS-S-LED-24
		NPN	3-wire	–	2.5	In-line	152 837	SMTO-4U-NS-K-LED-24
			–	3-pin	–	In-line	152 743	SMTO-4U-NS-S-LED-24

Ordering data – Proximity sensors, round design, magnetic reed							Technical data → Internet: smeo	
	Assembly	Electrical connection		Cable length [m]	Connection direction	Part No.	Type	
		Cable	Plug M8					
N/O contact								
	Via accessories	3-wire	–	2.5	In-line	36 198	SMEO-4U-K-LED-24	
			5	In-line	175 401	SMEO-4U-K5-LED-24		
		–	3-pin	–	In-line	151 526	SMEO-4U-S-LED-24-B	

Ordering data – Proximity sensors, round design, magnetic reed, corrosion-resistant							Technical data → Internet: crsmeo	
	Assembly	Electrical connection		Cable length [m]	Connection direction	Part No.	Type	
		Cable	Plug M8					
N/O contact								
	Via accessories	3-wire	–	2.5	In-line	161 775	CRSMEO-4-K-LED-24	



Ordering data – Mounting kits for proximity sensors SMEO/SMTO/CRSMEO						Technical data → Internet: crsmb	
Designation	For Ø					Part No.	Type
Mounting kit CRSMBR, corrosion-resistant							
	32					163 888	CRSMBR-32
	40					163 889	CRSMBR-40
	50					163 890	CRSMBR-50
	63					163 891	CRSMBR-63

Round cylinders DSNU/ESNU

Accessories

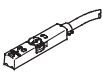
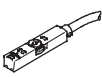
FESTO

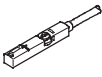
Ordering data – Proximity sensors for T-slot, magneto-resistive						Technical data → Internet: smt	
	Type of mounting	Switch output	Electrical connection	Cable length [m]	Part No.	Type	
N/O contact							
	Insertable in the slot from above, flush with cylinder profile, short design	PNP	Cable, 3-wire	2.5	574335	SMT-8M-A-PS-24V-E-2,5-OE	
			Plug M8x1, 3-pin	0.3	574334	SMT-8M-A-PS-24V-E-0,3-M8D	
			Plug M12x1, 3-pin	0.3	574337	SMT-8M-A-PS-24V-E-0,3-M12	
		NPN	Cable, 3-wire	2.5	574338	SMT-8M-A-NS-24V-E-2,5-OE	
			Plug M8x1, 3-pin	0.3	574339	SMT-8M-A-NS-24V-E-0,3-M8D	
N/C contact							
	Insertable in the slot from above, flush with cylinder profile, short design	PNP	Cable, 3-wire	7.5	574340	SMT-8M-A-PO-24V-E-7,5-OE	

Ordering data – Proximity sensors for T-slot, magnetic reed						Technical data → Internet: sme		
	Type of mounting	Switching output	Electrical connection	Cable length [m]	Part No.	Type		
N/O contact								
	Insertable in the slot from above, flush with the cylinder profile	Contacting	Cable, 3-wire	2.5	543 862	SME-8M-DS-24V-K-2,5-OE		
				5.0	543 863	SME-8M-DS-24V-K-5,0-OE		
			Plug M8x1, 3-pin	Cable, 2-wire	2.5	543 872	SME-8M-ZS-24V-K-2,5-OE	
				0.3	543 861	SME-8M-DS-24V-K-0,3-M8D		
	Insertable in the slot lengthwise, flush with the cylinder profile	Contacting	Cable, 3-wire	2.5	150 855	SME-8-K-LED-24		
			Plug M8x1, 3-pin	0.3	150 857	SME-8-S-LED-24		
N/C contact								
	Insertable in the slot lengthwise, flush with the cylinder profile	Contacting	Cable, 3-wire	7.5	160 251	SME-8-O-K-LED-24		



Ordering data – Mounting kits for proximity sensors SME/SMT-8					Technical data → Internet: smbr		
Designation	For Ø		Part No.	Type			
Mounting kit SMBR-8							
	32		175 097	SMBR-8-32			
	40		175 098	SMBR-8-40			
	50		175 099	SMBR-8-50			
	63		175 100	SMBR-8-63			

Round cylinders DSNU/ESNU



Accessories

FESTO

Ordering data – Proximity sensors for C-slot, magneto-resistive						Technical data → Internet: smt
	Type of mounting	Switching output	Electrical connection, connection direction	Cable length [m]	Part No.	Type
N/O contact						
	Insertable in the slot from above	PNP	Cable, 3-wire, in-line	2.5	551 373	SMT-10M-PS-24V-E-2,5-L-OE
			Plug M8x1, 3-pin, in-line	0.3	551 375	SMT-10M-PS-24V-E-0,3-L-M8D
			Plug M8x1, 3-pin, lateral	0.3	551 376	SMT-10M-PS-24V-E-0,3-Q-M8D

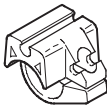
Ordering data – Proximity sensors for C-slot, magnetic reed						Technical data → Internet: sme
	Type of mounting	Switching output	Electrical connection, connection direction	Cable length [m]	Part No.	Type
N/O contact						
	Insertable in the slot from above	Contacting	Plug M8x1, 3-pin, in-line	0.3	551 367	SME-10M-DS-24V-E-0,3-L-M8D
			Cable, 3-wire, in-line	2.5	551 365	SME-10M-DS-24V-E-2,5-L-OE
			Cable, 2-wire, in-line	2.5	551 369	SME-10M-ZS-24V-E-2,5-L-OE
	Insertable in the slot lengthwise	Contacting	Plug M8x1, 3-pin, in-line	0.3	173 212	SME-10-SL-LED-24
			Cable, 3-wire, in-line	2.5	173 210	SME-10-KL-LED-24

Ordering data – Mounting kits for proximity sensors SME/SMT-10				Technical data → Internet: smbr
Designation	For Ø	Part No.	Type	
Mounting kit SMBR-10				
	32	175 105	SMBR-10-32	
	40	175 106	SMBR-10-40	
	50	175 107	SMBR-10-50	
	63	175 108	SMBR-10-63	

Ordering data – Connecting cables					Technical data → Internet: nebu
	Electrical connection, left	Electrical connection, right	Cable length [m]	Part No.	Type
	Straight socket, M8x1, 3-pin	Cable, open end, 3-wire	2.5	541 333	NEBU-M8G3-K-2.5-LE3
			5	541 334	NEBU-M8G3-K-5-LE3
	Straight socket, M12x1, 5-pin	Cable, open end, 3-wire	2.5	541 363	NEBU-M12G5-K-2.5-LE3
			5	541 364	NEBU-M12G5-K-5-LE3
	Angled socket, M8x1, 3-pin	Cable, open end, 3-wire	2.5	541 338	NEBU-M8W3-K-2.5-LE3
			5	541 341	NEBU-M8W3-K-5-LE3
	Angled socket, M12x1, 5-pin	Cable, open end, 3-wire	2.5	541 367	NEBU-M12W5-K-2.5-LE3
			5	541 370	NEBU-M12W5-K-5-LE3

Product Range and Company Overview

A Complete Suite of Automation Services

Our experienced engineers provide complete support at every stage of your development process, including: conceptualization, analysis, engineering, design, assembly, documentation, validation, and production.



Custom Automation Components
Complete custom engineered solutions



Custom Control Cabinets
Comprehensive engineering support and on-site services



Complete Systems
Shipment, stocking and storage services

The Broadest Range of Automation Components

With a comprehensive line of more than 30,000 automation components, Festo is capable of solving the most complex automation requirements.



Electromechanical
Electromechanical actuators, motors, controllers & drives



Pneumatics
Pneumatic linear and rotary actuators, valves, and air supply



PLCs and I/O Devices
PLC's, operator interfaces, sensors and I/O devices

Supporting Advanced Automation... As No One Else Can!

Festo is a leading global manufacturer of pneumatic and electromechanical systems, components and controls for industrial automation, with more than 12,000 employees in 56 national headquarters serving more than 180 countries. For more than 80 years, Festo has continuously elevated the state of manufacturing with innovations and optimized motion control solutions that deliver higher performing, more profitable automated manufacturing and processing equipment. Our dedication to the advancement of automation extends beyond technology to the education and development of current and future automation and robotics designers with simulation tools, teaching programs, and on-site services.

Quality Assurance, ISO 9001 and ISO 14001 Certifications

Festo Corporation is committed to supply all Festo products and services that will meet or exceed our customers' requirements in product quality, delivery, customer service and satisfaction.

To meet this commitment, we strive to ensure a consistent, integrated, and systematic approach to management that will meet or exceed the requirements of the ISO 9001 standard for Quality Management and the ISO 14001 standard for Environmental Management.



© Copyright 2008, Festo Corporation. While every effort is made to ensure that all dimensions and specifications are correct, Festo cannot guarantee that publications are completely free of any error, in particular typing or printing errors. Accordingly, Festo cannot be held responsible for the same. For Liability and Warranty conditions, refer to our "Terms and Conditions of Sale", available from your local Festo office. All rights reserved. No part of this publication may be reproduced, distributed, or transmitted in any form or by any means, electronic, mechanical, photocopying or otherwise, without the prior written permission of Festo. All technical data subject to change according to technical update.



Printed on recycled paper at New Horizon Graphic, Inc., FSC certified as an environmentally friendly printing plant.

Festo North America

Festo Regional Contact Center

5300 Explorer Drive
Mississauga, Ontario L4W 5G4
Canada

USA Customers:

For ordering assistance,

Call: 1.800.99.FESTO (1.800.993.3786)

Fax: 1.800.96.FESTO (1.800.963.3786)

Email: customer.service@us.festo.com

For technical support,

Call: 1.866.GO.FESTO (1.866.463.3786)

Fax: 1.800.96.FESTO (1.800.963.3786)

Email: product.support@us.festo.com

Canadian Customers:

Call: 1.877.GO.FESTO (1.877.463.3786)

Fax: 1.877.FX.FESTO (1.877.393.3786)

Email: festo.canada@ca.festo.com

USA Headquarters

Festo Corporation
395 Moreland Road
P.O. Box 18023
Hauppauge, NY 11788, USA
www.festo.com/us

USA Sales Offices

Appleton

North 922 Tower View Drive, Suite N
Greenville, WI 54942, USA

Boston

120 Presidential Way, Suite 330
Woburn, MA 01801, USA

Chicago

1441 East Business Center Drive
Mt. Prospect, IL 60056, USA

Dallas

1825 Lakeway Drive, Suite 600
Lewisville, TX 75057, USA

Detroit – Automotive Engineering Center

2601 Cambridge Court, Suite 320
Auburn Hills, MI 48326, USA

New York

395 Moreland Road
Hauppauge, NY 11788, USA

Silicon Valley

4935 Southfront Road, Suite F
Livermore, CA 94550, USA

United States



USA Headquarters, East: Festo Corp., 395 Moreland Road, Hauppauge, NY 11788

Phone: 1.631.435.0800; Fax: 1.631.435.8026;

Email: info@festo-usa.com

www.festo.com/us

Canada



Headquarters: Festo Inc., 5300 Explorer Drive, Mississauga, Ontario L4W 5G4

Phone: 1.905.624.9000; Fax: 1.905.624.9001;

Email: festo.canada@ca.festo.com

www.festo.ca

Mexico



Headquarters: Festo Pneumatic, S.A., Av. Ceylán 3, Col. Tequesquahuac,
54020 Tlalneantla, Edo. de México

Phone: 011 52 [55] 53 21 66 00; Fax: 011 52 [55] 53 21 66 65;

Email: festo.mexico@mx.festo.com

www.festo.com/mx

Central USA

Festo Corporation
1441 East Business
Center Drive
Mt. Prospect, IL 60056, USA
Phone: 1.847.759.2600
Fax: 1.847.768.9480



Western USA

Festo Corporation
4935 Southfront Road,
Suite F
Livermore, CA 94550, USA
Phone: 1.925.371.1099
Fax: 1.925.245.1286



Festo Worldwide

Argentina Australia Austria Belarus Belgium Brazil Bulgaria Canada Chile China Colombia Croatia Czech Republic Denmark
Estonia Finland France Germany Great Britain Greece Hong Kong Hungary India Indonesia Iran Ireland Israel Italy Japan Latvia
Lithuania Malaysia Mexico Netherlands New Zealand Norway Peru Philippines Poland Romania Russia Serbia Singapore
Slovakia Slovenia South Africa South Korea Spain Sweden Switzerland Taiwan Thailand Turkey Ukraine United States Venezuela

www.festo.com