

Operating Instructions

Proline Promag W 400

PROFIBUS DP

Electromagnetic flowmeter

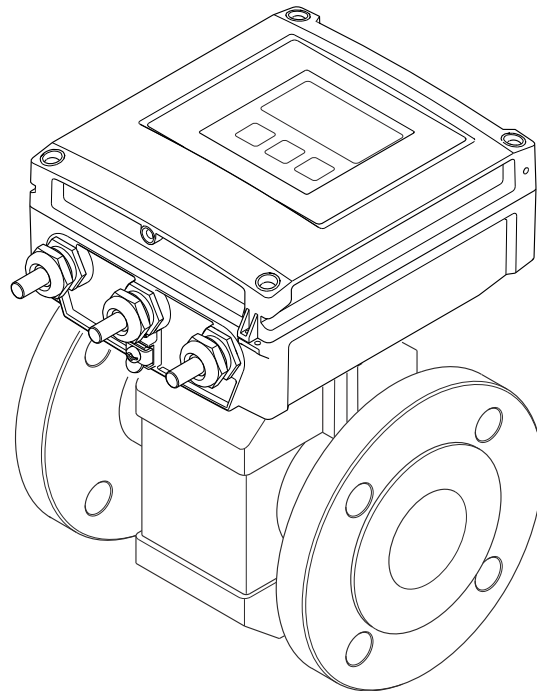

- Make sure the document is stored in a safe place such that it is always available when working on or with the device.
- To avoid danger to individuals or the facility, read the "Basic safety instructions" section carefully, as well as all other safety instructions in the document that are specific to working procedures.
- The manufacturer reserves the right to modify technical data without prior notice. Your Endress+Hauser Sales Center will supply you with current information and updates to these instructions.

Table of contents

1	About this document	6			
1.1	Document function	6			
1.2	Symbols	6			
1.2.1	Safety symbols	6			
1.2.2	Electrical symbols	6			
1.2.3	Communication symbols	6			
1.2.4	Tool symbols	7			
1.2.5	Symbols for certain types of information	7			
1.2.6	Symbols in graphics	7			
1.3	Documentation	8			
1.3.1	Standard documentation	8			
1.3.2	Supplementary device-dependent documentation	8			
1.4	Registered trademarks	8			
2	Safety instructions	9			
2.1	Requirements for the personnel	9			
2.2	Designated use	9			
2.3	Workplace safety	10			
2.4	Operational safety	10			
2.5	Product safety	10			
2.6	IT security	11			
2.7	Device-specific IT security	11			
2.7.1	Protecting access via a password	11			
2.7.2	Access via Web server	12			
3	Product description	13			
3.1	Product design	13			
4	Incoming acceptance and product identification	14			
4.1	Incoming acceptance	14			
4.2	Product identification	14			
4.2.1	Transmitter nameplate	15			
4.2.2	Sensor nameplate	15			
4.2.3	Symbols on measuring device	16			
5	Storage and transport	17			
5.1	Storage conditions	17			
5.2	Transporting the product	17			
5.2.1	Measuring devices without lifting lugs	17			
5.2.2	Measuring devices with lifting lugs	18			
5.2.3	Transporting with a fork lift	18			
5.3	Packaging disposal	18			
6	Installation	19			
6.1	Installation conditions	19			
6.1.1	Mounting location	19			
6.1.2	Orientation	21			
6.1.3	Inlet and outlet runs	23			
6.1.4	Dimensions	25			
6.1.5	Environment and process requirements	25			
6.1.6	Special mounting instructions	27			
6.2	Mounting the measuring device	28			
6.2.1	Required tool	28			
6.2.2	Preparing the measuring device	29			
6.2.3	Mounting the sensor	29			
6.2.4	Mounting the transmitter of the remote version	36			
6.2.5	Turning the transmitter housing	37			
6.2.6	Turning the display module	39			
6.3	Post-installation check	40			
7	Electrical connection	41			
7.1	Electrical safety	41			
7.2	Connection conditions	41			
7.2.1	Required tools	41			
7.2.2	Requirements for connecting cable	41			
7.2.3	Terminal assignment	43			
7.2.4	Shielding and grounding	44			
7.2.5	Preparing the measuring device	45			
7.2.6	Preparing the connecting cable for the remote version	46			
7.3	Connecting the measuring device	47			
7.3.1	Connecting the remote version	47			
7.3.2	Connecting the transmitter	50			
7.3.3	Ensuring potential equalization	52			
7.4	Special connection instructions	56			
7.4.1	Connection examples	56			
7.5	Hardware settings	56			
7.5.1	Setting the device address	56			
7.5.2	Enabling the terminating resistor	57			
7.6	Ensuring the degree of protection	58			
7.6.1	Degree of protection IP66/67, Type 4X enclosure	58			
7.6.2	Degree of protection IP68, Type 6P enclosure, with "Cust-potted" option	58			
7.7	Post-connection check	59			
8	Operation methods	60			
8.1	Overview of operation methods	60			
8.2	Structure and function of the operating menu	61			
8.2.1	Structure of the operating menu	61			
8.2.2	Operating philosophy	62			
8.3	Access to the operating menu via the local display	63			
8.3.1	Operational display	63			
8.3.2	Navigation view	65			
8.3.3	Editing view	67			
8.3.4	Operating elements	68			
8.3.5	Opening the context menu	69			

8.3.6	Navigating and selecting from list . . .	71	10.6.3	Configuring the totalizer	106
8.3.7	Calling the parameter directly	71	10.6.4	Carrying out additional display configurations	108
8.3.8	Calling up help text	72	10.6.5	Performing electrode cleaning	111
8.3.9	Changing the parameters	73	10.6.6	WLAN configuration	111
8.3.10	User roles and related access authorization	74	10.6.7	Using parameters for device administration	113
8.3.11	Disabling write protection via access code	74	10.7	Simulation	115
8.3.12	Enabling and disabling the keypad lock	75	10.8	Protecting settings from unauthorized access	116
8.4	Access to the operating menu via the Web browser	75	10.8.1	Write protection via access code . . .	116
8.4.1	Function scope	75	10.8.2	Write protection via write protection switch	117
8.4.2	Prerequisites	75	11	Operation	119
8.4.3	Establishing a connection	77	11.1	Reading the device locking status	119
8.4.4	Logging on	78	11.2	Adjusting the operating language	119
8.4.5	User interface	79	11.3	Configuring the display	119
8.4.6	Disabling the Web server	80	11.4	Reading measured values	119
8.4.7	Logging out	81	11.4.1	Process variables	119
8.5	Access to the operating menu via the operating tool	81	11.4.2	Totalizer	120
8.5.1	Connecting the operating tool	81	11.5	Adapting the measuring device to the process conditions	121
8.5.2	FieldCare	83	11.6	Performing a totalizer reset	121
8.5.3	DeviceCare	84	11.7	Showing data logging	122
8.5.4	Field Xpert SMT70, SMT77	85	12	Diagnostics and troubleshooting . .	126
9	System integration	86	12.1	General troubleshooting	126
9.1	Overview of device description files	86	12.2	Diagnostic information via light emitting diodes	127
9.1.1	Current version data for the device . . .	86	12.2.1	Transmitter	127
9.1.2	Operating tools	86	12.3	Diagnostic information on local display	129
9.2	Device master file (GSD)	86	12.3.1	Diagnostic message	129
9.2.1	Manufacturer-specific GSD	86	12.3.2	Calling up remedial measures	131
9.2.2	Profile GSD	87	12.4	Diagnostic information in the Web browser .	131
9.2.3	Compatibility with other Endress +Hauser measuring devices	87	12.4.1	Diagnostic options	131
9.3	Cyclic data transmission	89	12.4.2	Calling up remedy information	132
9.3.1	Block model	89	12.5	Diagnostic information in FieldCare or DeviceCare	132
9.3.2	Description of the modules	89	12.5.1	Diagnostic options	132
10	Commissioning	95	12.5.2	Calling up remedy information	133
10.1	Function check	95	12.6	Adapting the diagnostic information	134
10.2	Switching on the measuring device	95	12.6.1	Adapting the diagnostic behavior . . .	134
10.3	Configuring the device address via software . .	95	12.7	Overview of diagnostic information	136
10.3.1	PROFIBUS network	95	12.7.1	Diagnostic of sensor	137
10.4	Setting the operating language	95	12.7.2	Diagnostic of electronic	140
10.5	Configuring the measuring device	96	12.7.3	Diagnostic of configuration	152
10.5.1	Defining the tag name	97	12.7.4	Diagnostic of process	157
10.5.2	Setting the system units	98	12.8	Pending diagnostic events	161
10.5.3	Configuring communication interface	99	12.9	Diagnostic list	162
10.5.4	Configuring the local display	99	12.10	Event logbook	162
10.5.5	Configuring the analog inputs	102	12.10.1	Reading out the event logbook	162
10.5.6	Configuring the low flow cut off	103	12.10.2	Filtering the event logbook	163
10.5.7	Configuring empty pipe detection	104	12.10.3	Overview of information events	163
10.6	Advanced settings	105	12.11	Resetting the measuring device	165
10.6.1	Using the parameter to enter the access code	106	12.11.1	Function scope of the "Device reset" parameter	165
10.6.2	Carrying out a sensor adjustment	106	12.12	Device information	165
			12.13	Firmware history	167

13	Maintenance	168
13.1	Maintenance tasks	168
13.1.1	Exterior cleaning	168
13.1.2	Interior cleaning	168
13.2	Measuring and test equipment	168
13.3	Endress+Hauser services	168
14	Repair	169
14.1	General information	169
14.1.1	Repair and conversion concept	169
14.1.2	Notes for repair and conversion	169
14.2	Spare parts	169
14.3	Endress+Hauser services	169
14.4	Return	169
14.5	Disposal	170
14.5.1	Removing the measuring device	170
14.5.2	Disposing of the measuring device ..	170
15	Accessories	171
15.1	Device-specific accessories	171
15.1.1	For the transmitter	171
15.1.2	For the sensor	171
15.2	Communication-specific accessories	171
15.3	Service-specific accessories	172
15.4	System components	173
16	Technical data	174
16.1	Application	174
16.2	Function and system design	174
16.3	Input	174
16.4	Output	179
16.5	Power supply	181
16.6	Performance characteristics	182
16.7	Installation	184
16.8	Environment	184
16.9	Process	187
16.10	Mechanical construction	189
16.11	Human interface	198
16.12	Certificates and approvals	202
16.13	Application packages	203
16.14	Accessories	204
16.15	Supplementary documentation	204
Index	206	

1 About this document

1.1 Document function

These Operating Instructions contain all the information that is required in various phases of the life cycle of the device: from product identification, incoming acceptance and storage, to mounting, connection, operation and commissioning through to troubleshooting, maintenance and disposal.

1.2 Symbols

1.2.1 Safety symbols

DANGER

This symbol alerts you to a dangerous situation. Failure to avoid this situation will result in serious or fatal injury.

WARNING

This symbol alerts you to a dangerous situation. Failure to avoid this situation can result in serious or fatal injury.





CAUTION

This symbol alerts you to a dangerous situation. Failure to avoid this situation can result in minor or medium injury.



NOTICE



This symbol contains information on procedures and other facts which do not result in personal injury.

1.2.2 Electrical symbols



Symbol	Meaning
	Direct current
	Alternating current
	Direct current and alternating current
	Ground connection A grounded terminal which, as far as the operator is concerned, is grounded via a grounding system.
	Protective Earth (PE) A terminal which must be connected to ground prior to establishing any other connections. The ground terminals are situated inside and outside the device: <ul style="list-style-type: none"> ▪ Inner ground terminal: Connects the protective earth to the mains supply. ▪ Outer ground terminal: Connects the device to the plant grounding system.

1.2.3 Communication symbols













Symbol	Meaning
	Wireless Local Area Network (WLAN) Communication via a wireless, local network.
	Bluetooth Wireless data transmission between devices over a short distance.
	LED Light emitting diode is off.

Symbol	Meaning
	LED Light emitting diode is on.
	LED Light emitting diode is flashing.

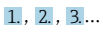

1.2.4 Tool symbols



Symbol	Meaning
	Torx screwdriver
	Phillips head screwdriver
	Open-ended wrench

1.2.5 Symbols for certain types of information

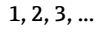
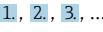
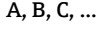
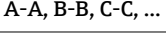
Symbol	Meaning
	Permitted Procedures, processes or actions that are permitted.
	Preferred Procedures, processes or actions that are preferred.
	Forbidden Procedures, processes or actions that are forbidden.
	Tip Indicates additional information.
	Reference to documentation
	Reference to page
	Reference to graphic
	Notice or individual step to be observed
	Series of steps
	Result of a step
	Help in the event of a problem
	Visual inspection

1.2.6 Symbols in graphics

Symbol	Meaning
	Item numbers
	Series of steps
	Views
	Sections
	Hazardous area

Symbol	Meaning
	Safe area (non-hazardous area)
	Flow direction

1.3 Documentation

 For an overview of the scope of the associated Technical Documentation, refer to the following:

- *W@M Device Viewer* (www.endress.com/deviceviewer): Enter the serial number from the nameplate
- *Endress+Hauser Operations App*: Enter the serial number from the nameplate or scan the matrix code on the nameplate

 Detailed list of the individual documents along with the documentation code
→  204

1.3.1 Standard documentation

Document type	Purpose and content of the document
Technical Information	Planning aid for your device The document contains all the technical data on the device and provides an overview of the accessories and other products that can be ordered for the device.
Sensor Brief Operating Instructions	Getting the 1st measured value quickly - Part 1 The Sensor Brief Operating Instructions are aimed at specialists with responsibility for installing the measuring device. <ul style="list-style-type: none"> ▪ Incoming acceptance and product identification ▪ Storage and transport ▪ Installation
Transmitter Brief Operating Instructions	Getting the 1st measured value quickly - Part 2 The Transmitter Brief Operating Instructions are aimed at specialists with responsibility for commissioning, configuring and parameterizing the measuring device (until the first measured value). <ul style="list-style-type: none"> ▪ Product description ▪ Installation ▪ Electrical connection ▪ Operation options ▪ System integration ▪ Commissioning ▪ Diagnostic information
Description of Device Parameters	Reference for your parameters The document provides a detailed explanation of each individual parameter in the Expert operating menu. The description is aimed at those who work with the device over the entire life cycle and perform specific configurations.

1.3.2 Supplementary device-dependent documentation

Additional documents are supplied depending on the device version ordered: Always comply strictly with the instructions in the supplementary documentation. The supplementary documentation is an integral part of the device documentation.

1.4 Registered trademarks

PROFIBUS®

Registered trademark of the PROFIBUS User Organization, Karlsruhe, Germany

2 Safety instructions

2.1 Requirements for the personnel

The personnel for installation, commissioning, diagnostics and maintenance must fulfill the following requirements:

- ▶ Trained, qualified specialists must have a relevant qualification for this specific function and task.
- ▶ Are authorized by the plant owner/operator.
- ▶ Are familiar with federal/national regulations.
- ▶ Before starting work, read and understand the instructions in the manual and supplementary documentation as well as the certificates (depending on the application).
- ▶ Follow instructions and comply with basic conditions.

The operating personnel must fulfill the following requirements:

- ▶ Are instructed and authorized according to the requirements of the task by the facility's owner-operator.
- ▶ Follow the instructions in this manual.

2.2 Designated use

Application and media

The measuring device described in this manual is intended only for the flow measurement of liquids with a minimum conductivity of 5 $\mu\text{S}/\text{cm}$.

Depending on the version ordered, the measuring device can also measure potentially explosive, flammable, poisonous and oxidizing media.

Measuring devices for use in hazardous areas, in hygienic applications or where there is an increased risk due to process pressure, are labeled accordingly on the nameplate.

To ensure that the measuring device remains in proper condition for the operation time:

- ▶ Keep within the specified pressure and temperature range.
- ▶ Only use the measuring device in full compliance with the data on the nameplate and the general conditions listed in the Operating Instructions and supplementary documentation.
- ▶ Based on the nameplate, check whether the ordered device is permitted for the intended use in the hazardous area (e.g. explosion protection, pressure vessel safety).
- ▶ Use the measuring device only for media to which the process-wetted materials are sufficiently resistant.
- ▶ If the ambient temperature of the measuring device is outside the atmospheric temperature, it is absolutely essential to comply with the relevant basic conditions as specified in the device documentation. →  8
- ▶ Protect the measuring device permanently against corrosion from environmental influences.

 The measuring device is optionally tested in accordance with OIML R49: 2006 and has an EC type-examination certificate according to Measuring Instruments Directive 2004/22/EC (MID) for service subject to legal metrological control ("custody transfer") for cold water (Annex MI-001).

The permitted medium temperature in these applications is 0 to +50 °C (+32 to +122 °F).

Incorrect use

Non-designated use can compromise safety. The manufacturer is not liable for damage caused by improper or non-designated use.

⚠ WARNING**Danger of breakage due to corrosive or abrasive fluids and ambient conditions!**

- ▶ Verify the compatibility of the process fluid with the sensor material.
- ▶ Ensure the resistance of all fluid-wetted materials in the process.
- ▶ Keep within the specified pressure and temperature range.

NOTICE**Verification for borderline cases:**

- ▶ For special fluids and fluids for cleaning, Endress+Hauser is glad to provide assistance in verifying the corrosion resistance of fluid-wetted materials, but does not accept any warranty or liability as minute changes in the temperature, concentration or level of contamination in the process can alter the corrosion resistance properties.

Residual risks**⚠ WARNING****If the temperature of the media or electronics unit is high or low, this may cause the surfaces of the device to become hot or cold. This poses a risk of burns or frostbite!**

- ▶ In the case of hot or cold medium temperatures, install appropriate protection against contact.

2.3 Workplace safety

For work on and with the device:

- ▶ Wear the required personal protective equipment according to national regulations.

For welding work on the piping:

- ▶ Do not ground the welding unit via the measuring device.

If working on and with the device with wet hands:

- ▶ Due to the increased risk of electric shock, wear suitable gloves.

2.4 Operational safety

Risk of injury.

- ▶ Operate the device in proper technical condition and fail-safe condition only.
- ▶ The operator is responsible for interference-free operation of the device.

Conversions to the device

Unauthorized modifications to the device are not permitted and can lead to unforeseeable dangers.

- ▶ If, despite this, modifications are required, consult with Endress+Hauser.

Repair

To ensure continued operational safety and reliability,

- ▶ Carry out repairs on the device only if they are expressly permitted.
- ▶ Observe federal/national regulations pertaining to repair of an electrical device.
- ▶ Use original spare parts and accessories from Endress+Hauser only.

2.5 Product safety

This measuring device is designed in accordance with good engineering practice to meet state-of-the-art safety requirements, has been tested, and left the factory in a condition in which it is safe to operate.

It meets general safety standards and legal requirements. It also complies with the EU directives listed in the device-specific EU Declaration of Conformity. Endress+Hauser confirms this by affixing the CE mark to the device.

Furthermore, the device meets the legal requirements of the applicable UK regulations (Statutory Instruments). These are listed in the UKCA Declaration of Conformity along with the designated standards.

By selecting the order option for UKCA marking, Endress+Hauser confirms a successful evaluation and testing of the device by affixing the UKCA mark.

Contact address Endress+Hauser UK:

Endress+Hauser Ltd.
Floats Road
Manchester M23 9NF
United Kingdom
www.uk.endress.com

2.6 IT security

Our warranty is valid only if the device is installed and used as described in the Operating Instructions. The device is equipped with security mechanisms to protect it against any inadvertent changes to the settings.

IT security measures, which provide additional protection for the device and associated data transfer, must be implemented by the operators themselves in line with their security standards.

2.7 Device-specific IT security

The device offers a range of specific functions to support protective measures on the operator's side. These functions can be configured by the user and guarantee greater in-operation safety if used correctly. An overview of the most important functions is provided in the following section.

2.7.1 Protecting access via a password

Different passwords are available to protect write access to the device parameters or access to the device via the WLAN interface.

- **User-specific access code**
Protect write access to the device parameters via the local display, Web browser or operating tool (e.g. FieldCare, DeviceCare). Access authorization is clearly regulated through the use of a user-specific access code.
- **WLAN passphrase**
The network key protects a connection between an operating unit (e.g. notebook or tablet) and the device via the WLAN interface which can be ordered as an option.

User-specific access code

Write access to the device parameters via the local display or operating tool (e.g. FieldCare, DeviceCare) can be protected by the modifiable, user-specific access code (→  116).

When the device is delivered, the device does not have an access code and is equivalent to 0000 (open).

WLAN passphrase: Operation as WLAN access point

A connection between an operating unit (e.g. notebook or tablet) and the device via the WLAN interface (→  82), which can be ordered as an optional extra, is protected by

the network key. The WLAN authentication of the network key complies with the IEEE 802.11 standard.

When the device is delivered, the network key is pre-defined depending on the device. It can be changed via the **WLAN settings** submenu in the **WLAN passphrase** parameter (→  113).

General notes on the use of passwords

- The access code and network key supplied with the device should be changed during commissioning.
- Follow the general rules for generating a secure password when defining and managing the access code or network key.
- The user is responsible for the management and careful handling of the access code and network key.
- For information on configuring the access code or on what to do if you lose the password, for example, see the "Write protection via access code" section →  116

2.7.2 Access via Web server

The device can be operated and configured via a Web browser with the integrated Web server (→  75). The connection is via the service interface (CDI-RJ45) or the WLAN interface.

The Web server is enabled when the device is delivered. The Web server can be disabled if necessary (e.g. after commissioning) via the **Web server functionality** parameter.

The device and status information can be hidden on the login page. This prevents unauthorized access to the information.



For detailed information on device parameters, see:
The "Description of Device Parameters" document →  205.

3 Product description

The device consists of a transmitter and a sensor.

Two device versions are available:

- Compact version - transmitter and sensor form a mechanical unit.
- Remote version - transmitter and sensor are mounted in separate locations.

3.1 Product design

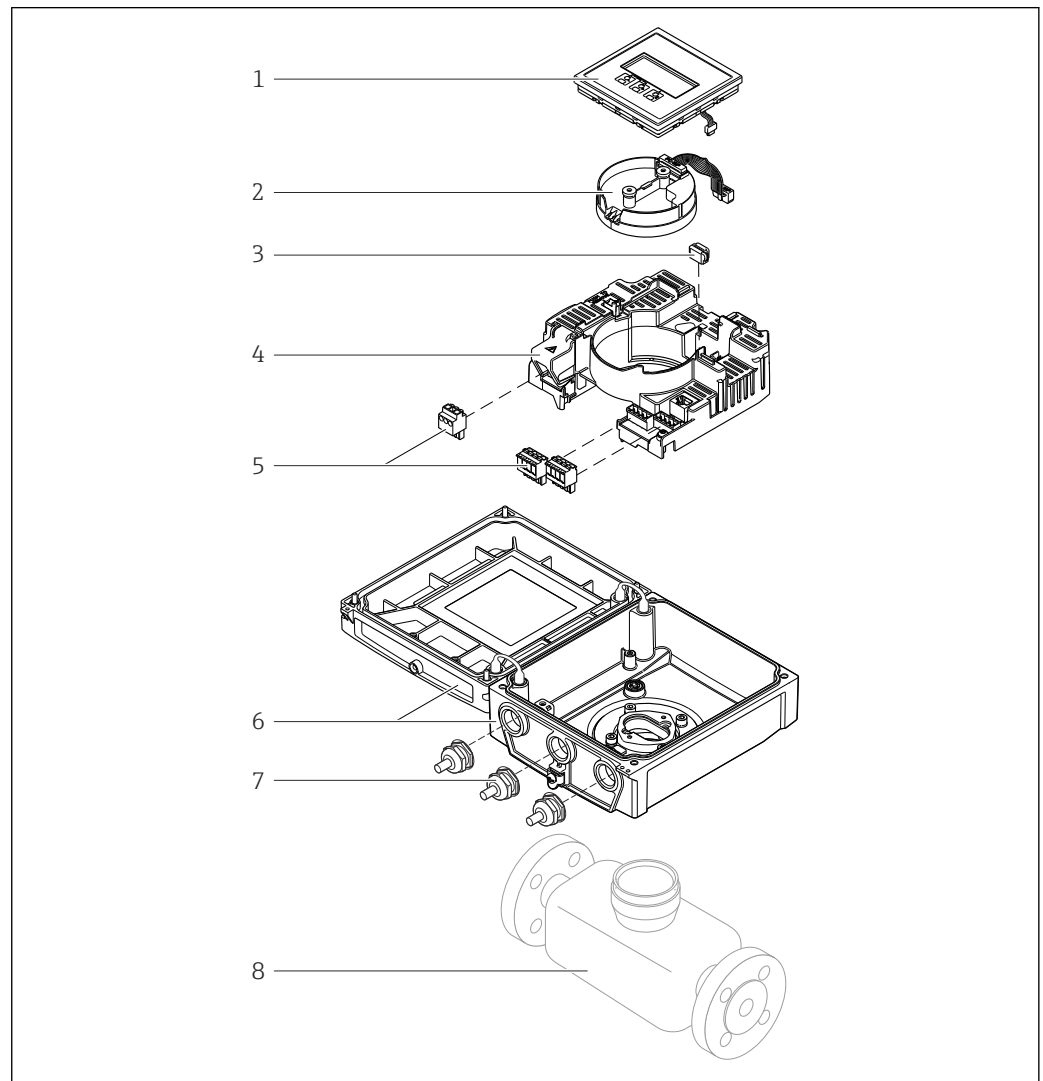

A0017218

1 Important components of the compact version

- 1 Display module
- 2 Smart sensor electronics module
- 3 HistoROM DAT (plug-in memory)
- 4 Main electronics module
- 5 Terminals (screw terminals, some available as plug-in terminals) or fieldbus connectors
- 6 Transmitter housing, compact version
- 7 Cable glands
- 8 Sensor, compact version

4 Incoming acceptance and product identification

4.1 Incoming acceptance

Are the order codes on the delivery note (1) and the product sticker (2) identical?

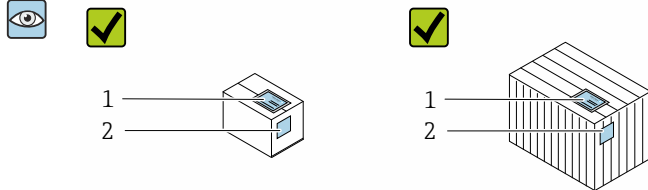

Are the goods undamaged?

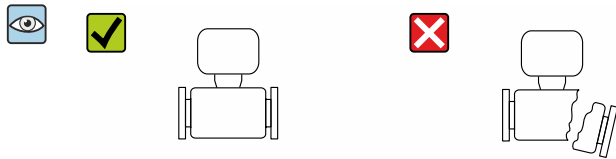

Do the nameplate data match the ordering information on the delivery note?

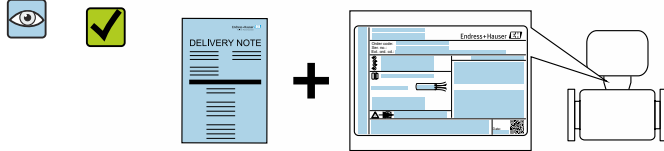

Is the envelope present with accompanying documents?

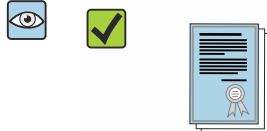



- i** ■ If one of the conditions is not satisfied, contact your Endress+Hauser Sales Center.
- The Technical Documentation is available via the Internet or via the *Endress+Hauser Operations App*, see the "Product identification" section → 15.

4.2 Product identification

The following options are available for identification of the device:

- Nameplate specifications
- Order code with breakdown of the device features on the delivery note
- Enter the serial numbers from the nameplates in *W@M Device Viewer* (www.endress.com/deviceviewer): all the information about the device is displayed.
- Enter the serial numbers from the nameplates into the *Endress+Hauser Operations App* or scan the DataMatrix code on the nameplate with the *Endress+Hauser Operations App*: all the information about the device is displayed.

For an overview of the scope of the associated Technical Documentation, refer to the following:

- The chapters "Additional standard documentation on the device" →  8 and "Supplementary device-dependent documentation" →  8
- The *W@M Device Viewer*: Enter the serial number from the nameplate (www.endress.com/deviceviewer)
- The *Endress+Hauser Operations App*: Enter the serial number from the nameplate or scan the DataMatrix code on the nameplate.

4.2.1 Transmitter nameplate

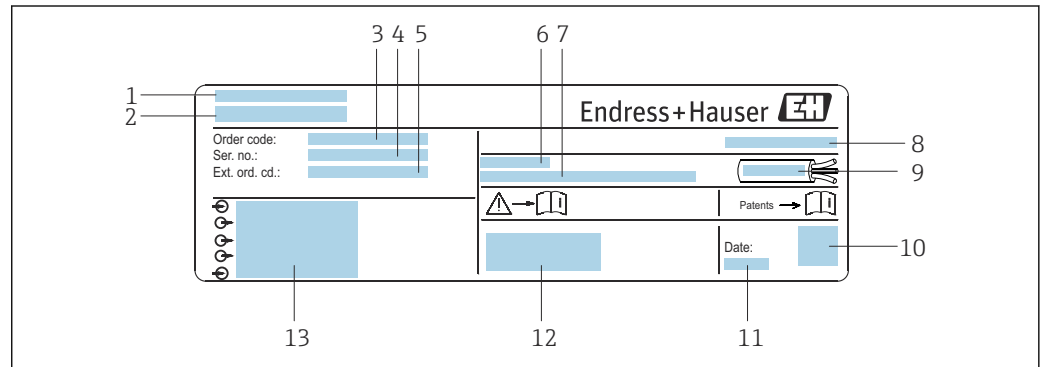

A0017346

 2 Example of a transmitter nameplate

- 1 Place of manufacture
- 2 Name of the transmitter
- 3 Order code
- 4 Serial number (Ser. no.)
- 5 Extended order code (Ext. ord. cd.)
- 6 Permitted ambient temperature (T_a)
- 7 Firmware version (FW) and device revision (Dev.Rev.) from the factory
- 8 Degree of protection
- 9 Permitted temperature range for cable
- 10 2-D matrix code
- 11 Date of manufacture: year-month
- 12 CE mark, RCM-Tick mark
- 13 Electrical connection data, e.g. available inputs and outputs, supply voltage

4.2.2 Sensor nameplate





Order code

The measuring device is reordered using the order code.

Extended order code

- The device type (product root) and basic specifications (mandatory features) are always listed.
- Of the optional specifications (optional features), only the safety and approval-related specifications are listed (e.g. LA). If other optional specifications are also ordered, these are indicated collectively using the # placeholder symbol (e.g. #LA#).
- If the ordered optional specifications do not include any safety and approval-related specifications, they are indicated by the + placeholder symbol (e.g. XXXXXX-ABCDE+).

4.2.3 Symbols on measuring device

Symbol	Meaning
	WARNING! This symbol alerts you to a dangerous situation. Failure to avoid this situation can result in serious or fatal injury. To determine the nature of the potential hazard and the measures required to avoid it, consult the documentation accompanying the measuring device.
	Reference to documentation Refers to the corresponding device documentation.
	Protective ground connection A terminal which must be connected to ground prior to establishing any other connections.

5 Storage and transport

5.1 Storage conditions

Observe the following notes for storage:

- ▶ Store in the original packaging to ensure protection from shock.
- ▶ Do not remove protective covers or protective caps installed on process connections. They prevent mechanical damage to the sealing surfaces and contamination in the measuring tube.
- ▶ Protect from direct sunlight to avoid unacceptably high surface temperatures.
- ▶ Select a storage location where moisture cannot collect in the measuring device as fungus and bacteria infestation can damage the liner.
- ▶ Store in a dry and dust-free place.
- ▶ Do not store outdoors.

Storage temperature →  184

5.2 Transporting the product

Transport the measuring device to the measuring point in the original packaging.

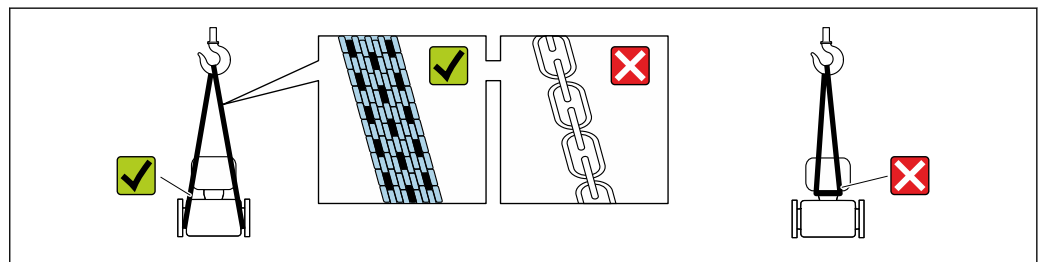

A0029252

-  Do not remove protective covers or caps installed on process connections. They prevent mechanical damage to the sealing surfaces and contamination in the measuring tube.

5.2.1 Measuring devices without lifting lugs

WARNING

Center of gravity of the measuring device is higher than the suspension points of the webbing slings.

Risk of injury if the measuring device slips.

- ▶ Secure the measuring device against slipping or turning.
- ▶ Observe the weight specified on the packaging (stick-on label).

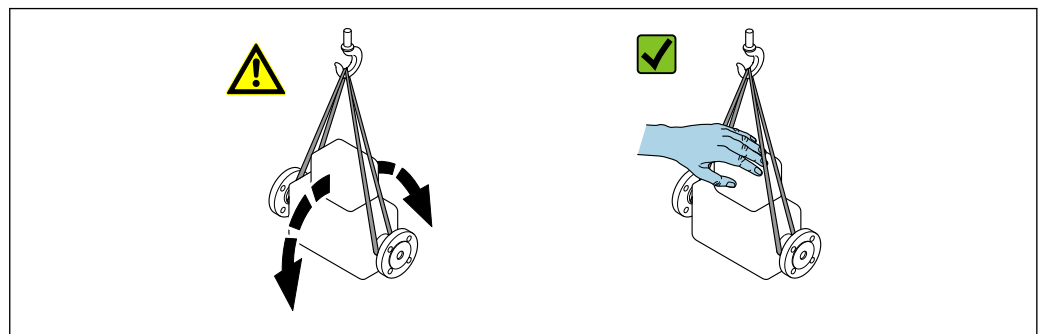

A0029214

5.2.2 Measuring devices with lifting lugs

⚠ CAUTION

Special transportation instructions for devices with lifting lugs

- ▶ Only use the lifting lugs fitted on the device or flanges to transport the device.
- ▶ The device must always be secured at two lifting lugs at least.

5.2.3 Transporting with a fork lift

If transporting in wood crates, the floor structure enables the crates to be lifted lengthwise or at both sides using a forklift.

⚠ CAUTION

Risk of damaging the magnetic coil

- ▶ If transporting by forklift, do not lift the sensor by the metal casing.
- ▶ This would buckle the casing and damage the internal magnetic coils.

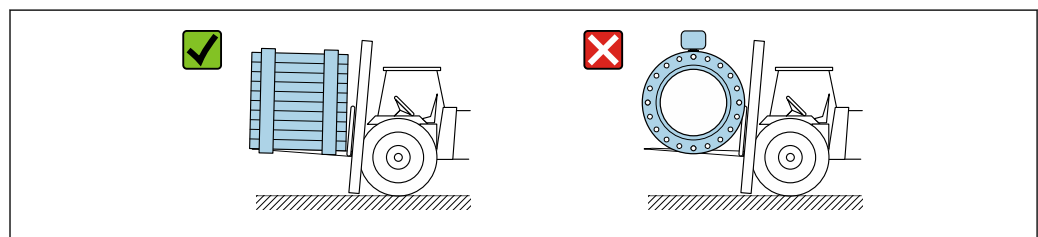

A0029319

5.3 Packaging disposal

All packaging materials are environmentally friendly and 100 % recyclable:

- Outer packaging of device
 - Polymer stretch wrap, complying with EU Directive 2002/95/EC (RoHS)
- Packaging
 - Wooden crate treated in accordance with ISPM 15 standard, confirmed by IPPC logo
 - Cardboard box in accordance with European packaging guideline 94/62EC, recyclability confirmed by Resy symbol
- Carrying and securing materials
 - Disposable plastic pallet
 - Plastic straps
 - Plastic adhesive strips
- Filler material
 - Paper pads

6 Installation

6.1 Installation conditions

6.1.1 Mounting location

- Do not install the device at the highest point of the pipe.
- Do not install the device upstream from a free pipe outlet in a down pipe.

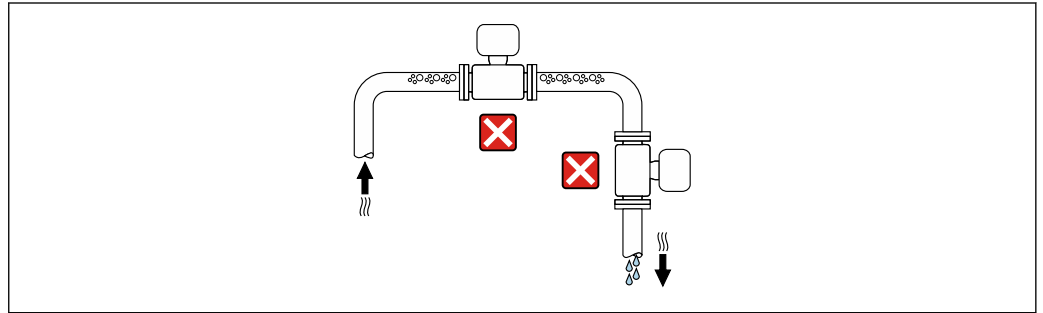

A0042131

The device should ideally be installed in an ascending pipe.

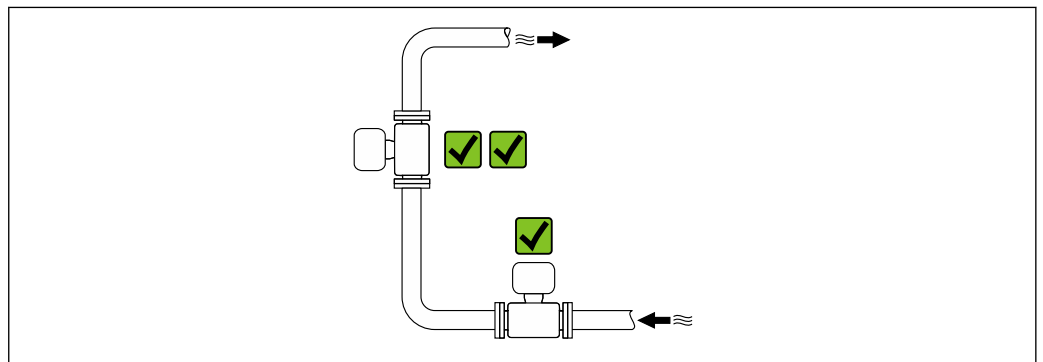

A0042137

Installation near valves

Install the device in the direction of flow upstream from the valve.

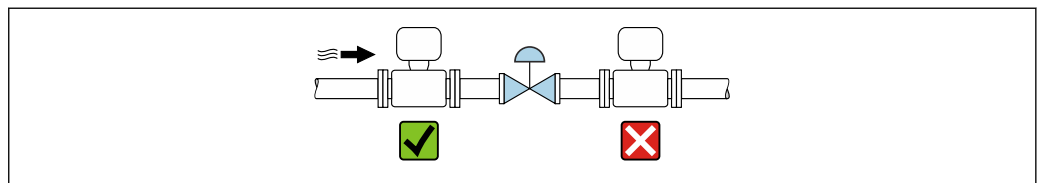

A0041091

Installation upstream from a down pipe

NOTICE

Negative pressure in the measuring pipe can damage the liner!

- ▶ If installing upstream from down pipes with a length $h \geq 5$ m (16.4 ft), install a siphon with a vent valve downstream from the device.

i This arrangement prevents the stoppage of liquid flow and the formation of air pockets.

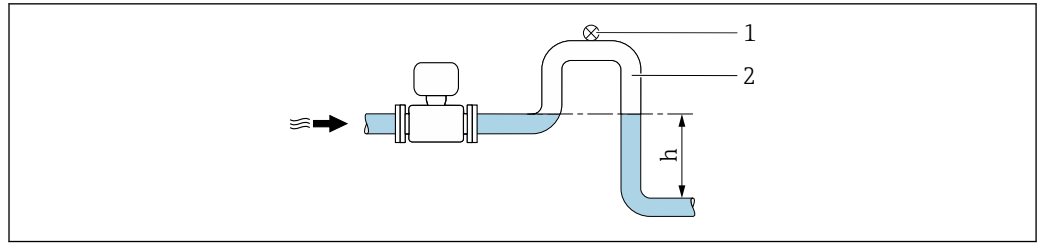

A0028981

- 1 Vent valve
- 2 Pipe siphon
- h Length of down pipe

Installation with partially filled pipes

- Partially filled pipes with a gradient require a drain-type configuration.
- The installation of a cleaning valve is recommended.

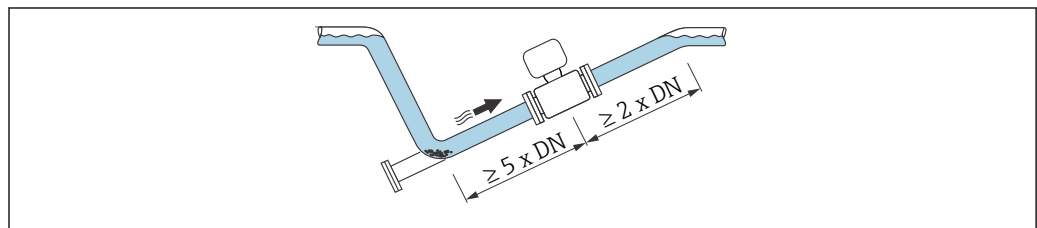

A0041088

- i** No inlet and outlet runs for devices with the order code for "Design": Option C, H, I, J or K.

Installation near pumps

NOTICE

Negative pressure in the measuring pipe can damage the liner!

- ▶ In order to maintain the system pressure, install the device in the flow direction downstream from the pump.
- ▶ Install pulsation dampers if reciprocating, diaphragm or peristaltic pumps are used.

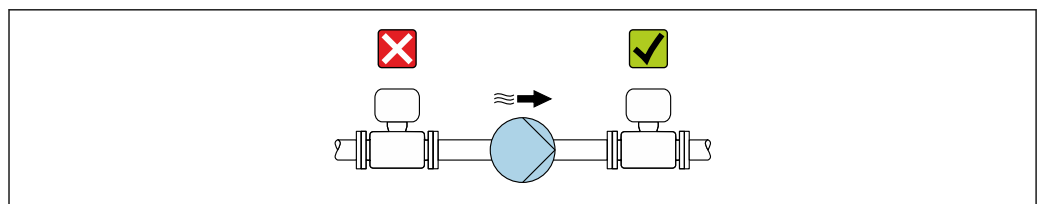

A0041083

- i** ■ Information on the liner's resistance to partial vacuum → 187
- Information on the measuring system's resistance to vibration and shock → 185

Installation of very heavy devices

Support required for nominal diameters of DN ≥ 350 mm (14 in).

NOTICE

Damage to the device!

If incorrect support is provided, the sensor housing could buckle and the internal magnetic coils could be damaged.

- ▶ Only provide supports at the pipe flanges.

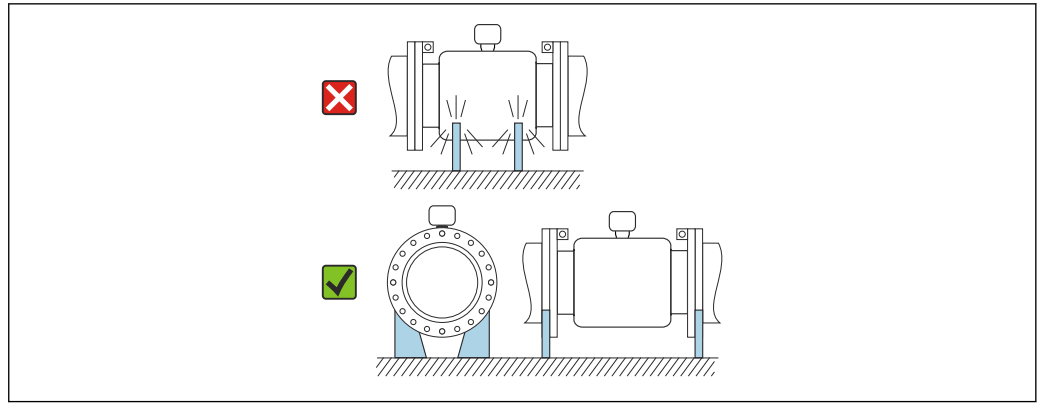

A0041087

Installation in event of pipe vibrations

A remote version is recommended in the event of strong pipe vibrations.

NOTICE

Pipe vibrations can damage the device!

- ▶ Do not expose the device to strong vibrations.
- ▶ Support the pipe and fix it in place.
- ▶ Support the device and fix it in place.
- ▶ Mount the sensor and transmitter separately.

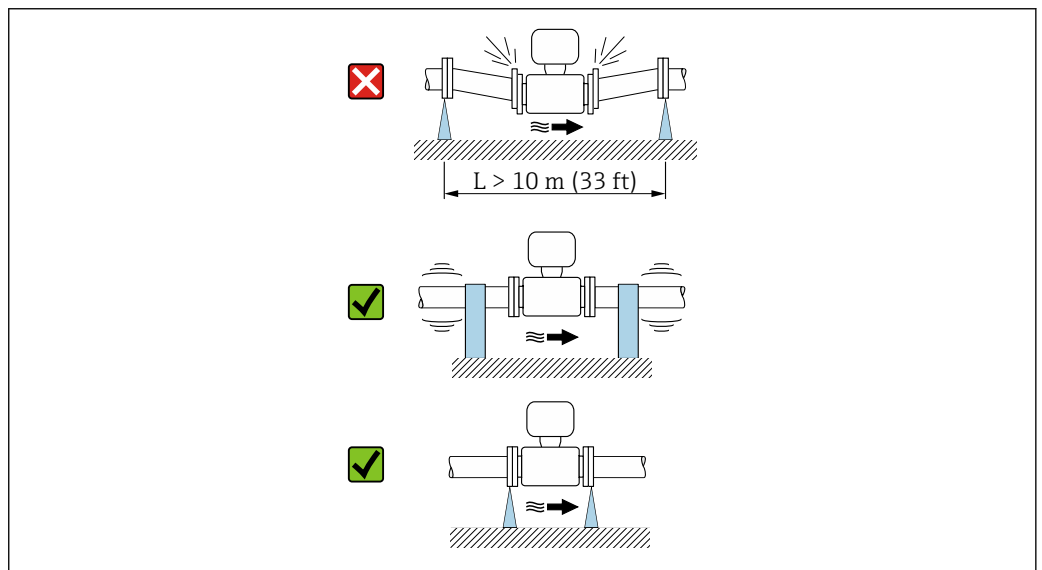



A0041092

 Information on the measuring system's resistance to vibration and shock →  185

6.1.2 Orientation

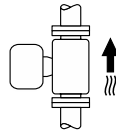
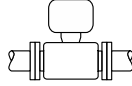
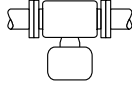
The direction of the arrow on the sensor nameplate helps you to install the sensor according to the flow direction (direction of medium flow through the piping).

Orientation		Recommendation
Vertical orientation	 A0015591	☑☑
Horizontal orientation, transmitter at top	 A0015589	☑☑ ¹⁾
Horizontal orientation, transmitter at bottom	 A0015590	☑☑ ^{2) 3)} ☒ ⁴⁾
Horizontal orientation, transmitter at side	 A0015592	☒

- 1) Applications with low process temperatures may decrease the ambient temperature. To maintain the minimum ambient temperature for the transmitter, this orientation is recommended.
- 2) Applications with high process temperatures may increase the ambient temperature. To maintain the maximum ambient temperature for the transmitter, this orientation is recommended.
- 3) To prevent the electronics module from overheating in the case of a sharp rise in temperature (e.g. CIP or SIP processes), install the device with the transmitter component pointing downwards.
- 4) With the empty pipe detection function switched on: empty pipe detection only works if the transmitter housing is pointing upwards.

Vertical

Optimum for self-emptying pipe systems and for use in conjunction with empty pipe detection.

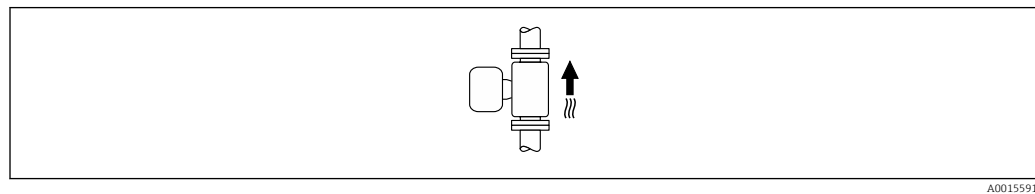

Horizontal

- Ideally, the measuring electrode plane should be horizontal. This prevents brief insulation of the measuring electrodes by entrained air bubbles.
- Empty pipe detection only works if the transmitter housing is pointing upwards as otherwise there is no guarantee that the empty pipe detection function will actually respond to a partially filled or empty measuring tube.

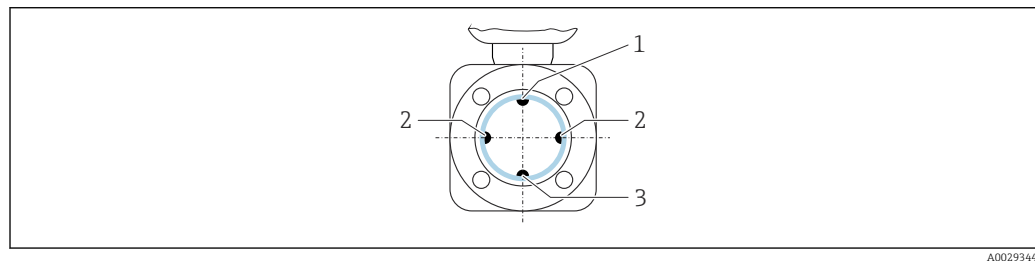

- 1 *EPD electrode for empty pipe detection*
- 2 *Measuring electrodes for signal detection*
- 3 *Reference electrode for potential equalization*

6.1.3 Inlet and outlet runs

Installation with inlet and outlet runs

Installation requires inlet and outlet runs: devices with the order code for "Design", option D, E, F and G.

Installation with elbows, pumps or valves

To avoid a vacuum and to maintain the specified level of accuracy, install the device upstream from assemblies that produce turbulence (e.g. valves, T-sections) and downstream from pumps, wherever possible.

Maintain straight, unimpeded inlet and outlet runs.

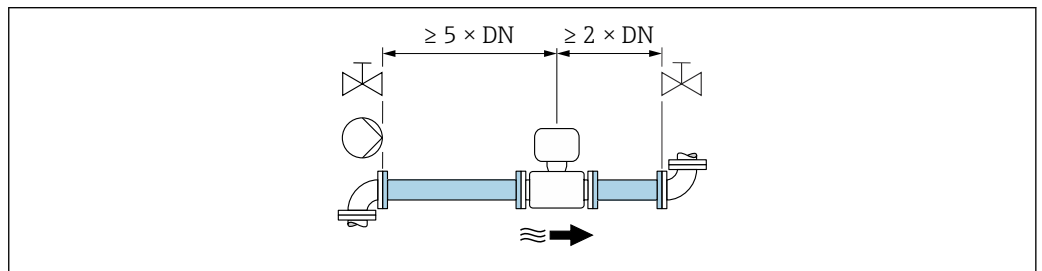

A0028997

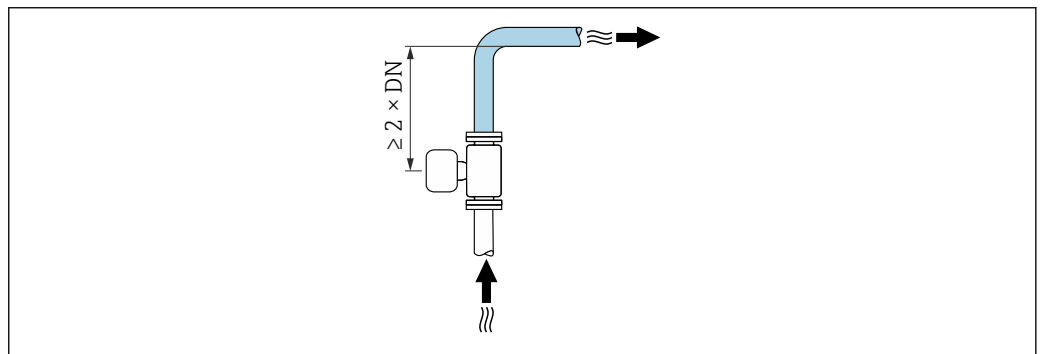

A0042132

Installation without inlet and outlet runs

Depending on the device design and installation location, the inlet and outlet runs can be reduced or omitted entirely.

i Maximum measured error

When the device is installed with the inlet and outlet runs described, a maximum measured error of $\pm 0.5\%$ of the reading $\pm 1 \text{ mm/s}$ (0.04 in/s) can be guaranteed.

Devices and possible order options

Order code for "Design"		
Option	Description	Design
C	Fixed flange, constricted measuring tube, 0 x DN inlet/outlet runs	Constricted measuring tube ¹⁾
H	Lap joint flange, 0 x DN inlet/outlet runs	Full Bore ²⁾
I	Fixed flange, 0 x DN inlet/outlet runs	

Order code for "Design"		
Option	Description	Design
J	Fixed flange, short installed length, 0 x DN inlet/ outlet runs	
K	Fixed flange, long installed length, 0 x DN inlet/ outlet runs	

- 1) "Constricted measuring tube" stands for a reduction of the internal diameter of the measuring tube. The reduced internal diameter causes a higher flow velocity inside the measuring tube.
- 2) "Full Bore" stands for the full diameter of the measuring tube. There is no pressure loss with a full diameter.

Installation before or after bends

Installation without inlet and outlet runs is possible: devices with the order code for "Design", option C, H, I, J and K.

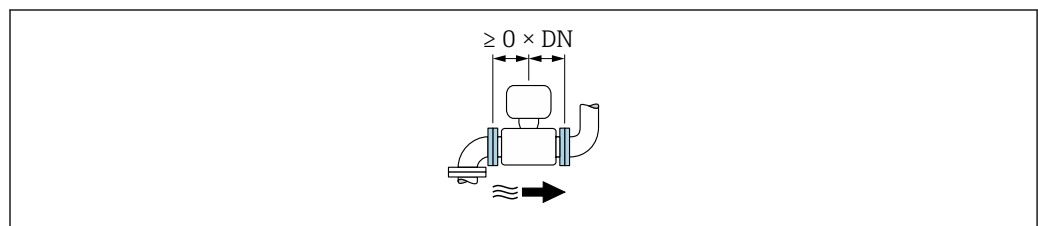

Installation downstream of pumps

Installation without inlet and outlet runs is possible: devices with the order code for "Design", option C, H and I.

i In the case of devices with the order code for "Design", option J and K, an inlet run of only $\geq 2 \times \text{DN}$ must be taken into consideration.

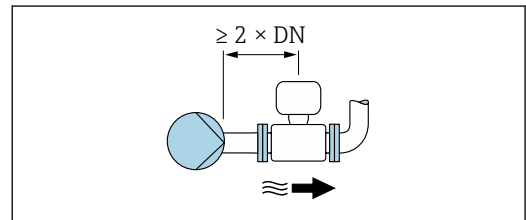

Installation upstream of valves

Installation without inlet and outlet runs is possible: devices with the order code for "Design", option C, H and I.

i In the case of devices with the order code for "Design", option J and K, an outlet run of only $\geq 1 \times \text{DN}$ must be taken into consideration.

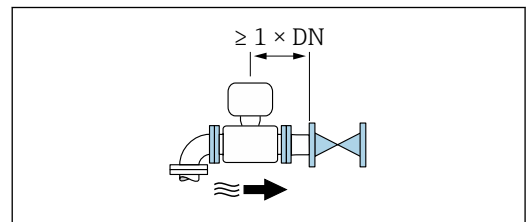

Installation downstream of valves

Installation without inlet and outlet runs is possible if the valve is 100% open during operation: devices with the order code for "Design", option C, H and I.

i In the case of devices with the order code for "Design", option J and K, an inlet run of only $\geq 2 \times \text{DN}$ must be taken into consideration if the valve is 100% open during operation.

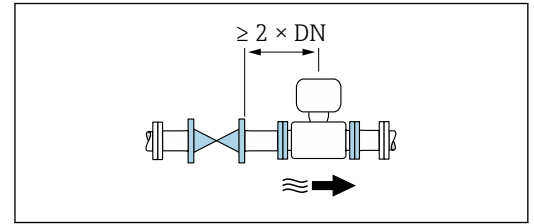

6.1.4 Dimensions

i For the dimensions and installed lengths of the device, see the "Technical Information" document, "Mechanical construction" section → [☰ 204](#)

6.1.5 Environment and process requirements

Ambient temperature range

Transmitter	-40 to +60 °C (-40 to +140 °F)
Local display	-20 to +60 °C (-4 to +140 °F), the legibility of the local display may be impaired at temperatures outside the temperature range.
Sensor	<ul style="list-style-type: none"> ▪ Process connection material, carbon steel: -10 to +60 °C (+14 to +140 °F) ▪ Process connection material, stainless steel: -40 to +60 °C (-40 to +140 °F) <p>If both the ambient and the medium temperatures are high, mount the sensor separately from the transmitter.</p>
Liner	Do not exceed or fall below the permitted temperature range of the liner → ☰ 187 .

If operating outdoors:

- Install the measuring device in a shady location.
- Avoid direct sunlight, particularly in warm climatic regions.
- Avoid direct exposure to weather conditions.
- If the compact version of the device is insulated at low temperatures, the insulation must also include the device neck.
- Protect the display against impact.
- Protect the display from abrasion, e.g. caused by sand in desert areas.

i Display guard available as an accessory → [☰ 171](#).

Temperature tables

i Observe the interdependencies between the permitted ambient and fluid temperatures when operating the device in hazardous areas.

i For detailed information on the temperature tables, see the separate document entitled "Safety Instructions" (XA) for the device.

System pressure

Installation near pumps → [☰ 20](#)

Vibrations

Installation in event of pipe vibrations → [☰ 21](#)

Adapters

Suitable adapters to DIN EN 545 (double-flange reducers) can be used to install the sensor in larger-diameter pipes. The resultant increase in the rate of flow improves measuring accuracy with very slow-moving fluids. The nomogram shown here can be used to calculate the pressure loss caused by reducers and expanders.

 The nomogram only applies to liquids with a viscosity similar to that of water.

1. Calculate the ratio of the diameters d/D .
2. From the nomogram read off the pressure loss as a function of flow velocity (downstream from the reduction) and the d/D ratio.

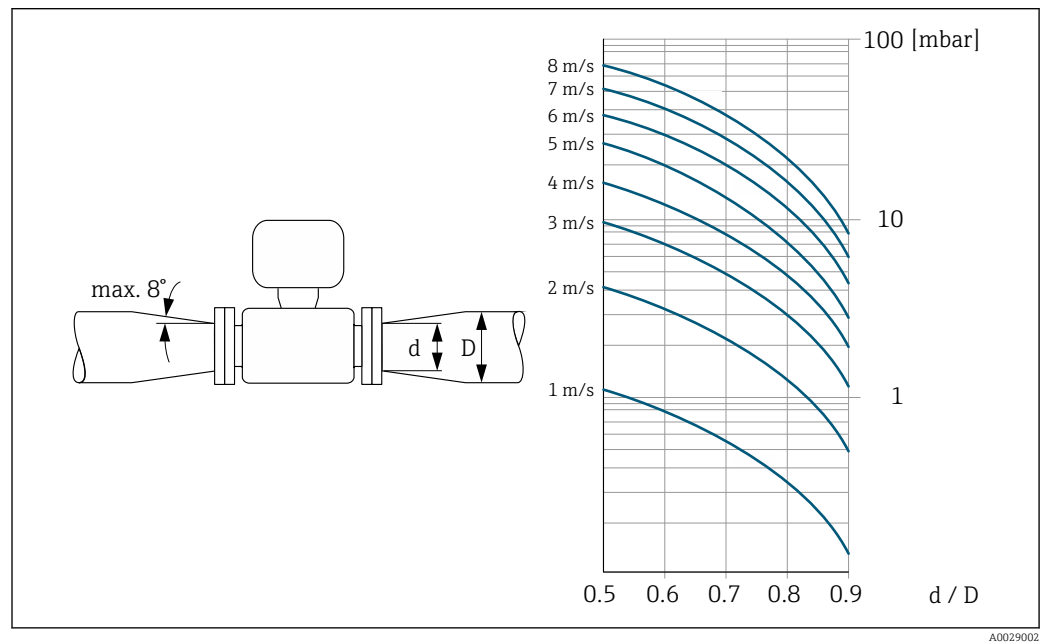

Length of connecting cable

To obtain correct measurement results, observe the permitted connecting cable length of L_{max} . This length is determined by the conductivity of the fluid. If measuring liquids in general: 5 $\mu\text{S}/\text{cm}$

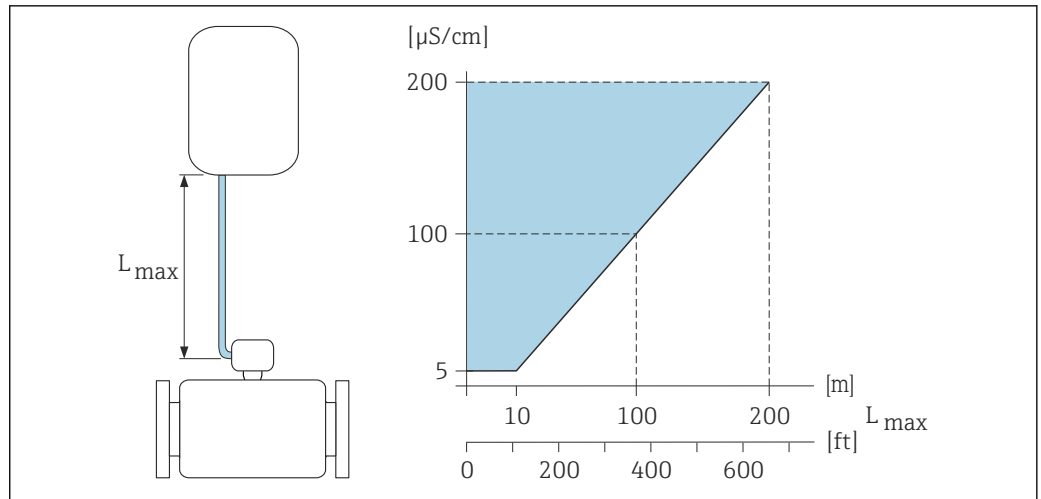

3 Permitted length of connecting cable

Colored area = permitted range

L_{max} = length of connecting cable in [m] ([ft])

[$\mu\text{S}/\text{cm}$] = fluid conductivity

A0016539

6.1.6 Special mounting instructions

Display guard

- ▶ To ensure that the optional display guard can be easily opened, maintain the following minimum head clearance: 350 mm (13.8 in)

Immersion in water

- i** Only the remote version of the device with IP68 protection, Type 6P is suitable for underwater use: order code for "Sensor option", options CB, CC, CD, CE and CQ.
 - Pay attention to regional installation instructions.

NOTICE

If the maximum water depth and operating duration is exceeded, this can damage the device!

- ▶ Observe the maximum water depth and operating duration.

Order code for "Sensor option", options CB, CC

- For the operation of the device under water
- Operating duration at a maximum depth of:
 - 3 m (10 ft): permanent use
 - 10 m (30 ft): maximum 48 hours

Order code for "Sensor option", option CQ "Temporarily water-proof"

- For the temporary operation of the device under non-corrosive water
- Operating duration at a maximum depth of:
 - 3 m (10 ft): maximum 168 hours

Order code for "Sensor option", options CD, CE

- For the operation of the device under water and in saline water
- Operating duration at a maximum depth of:
 - 3 m (10 ft): permanent use
 - 10 m (30 ft): maximum 48 hours

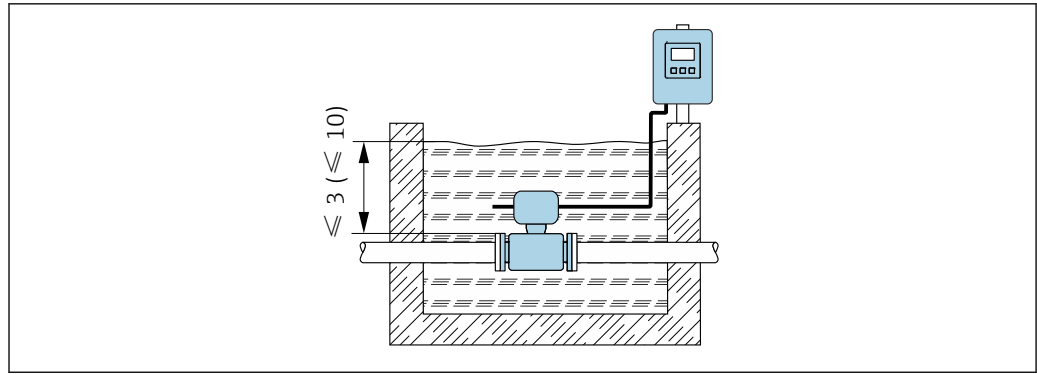

Use in buried applications

- i** Only the remote version of the device with IP68 protection is suitable for use in buried applications: order code for "Sensor option", options CD and CE.
 - Pay attention to regional installation instructions.

Order code for "Sensor option", options CD, CE

For the use of the device in buried applications.

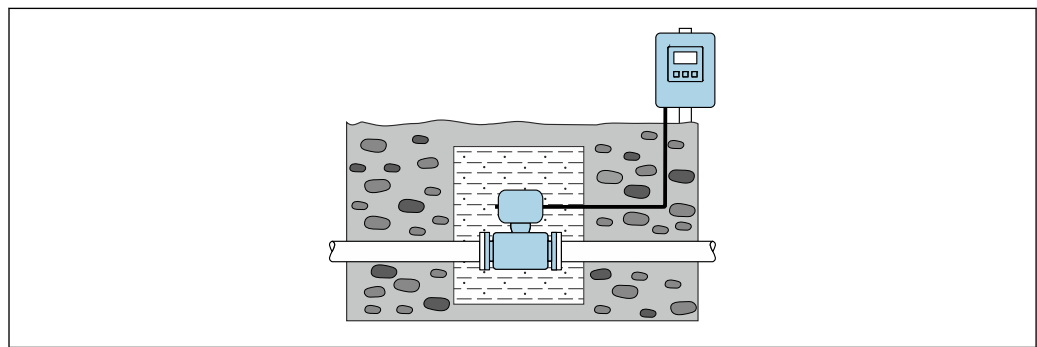

6.2 Mounting the measuring device

6.2.1 Required tool

For transmitter

- Torque wrench
- For wall mounting:
 - Open-ended wrench for hexagonal screw max. M5
- For pipe mounting:
 - Open-ended wrench AF 8
 - Phillips head screwdriver PH 2
- For turning the transmitter housing (compact version):
 - Phillips head screwdriver PH 2
 - Torx screwdriver TX 20
 - Open-ended wrench AF 7

For sensor

For flanges and other process connections: use a suitable mounting tool

6.2.2 Preparing the measuring device

1. Remove all remaining transport packaging.
2. Remove any protective covers or protective caps present from the sensor.
3. Remove stick-on label on the electronics compartment cover.

6.2.3 Mounting the sensor

⚠ WARNING

Danger due to improper process sealing!

- ▶ Ensure that the inside diameters of the gaskets are greater than or equal to that of the process connections and piping.
 - ▶ Ensure that the seals are clean and undamaged.
 - ▶ Secure the seals correctly.
1. Ensure that the direction of the arrow on the sensor matches the flow direction of the medium.
 2. To ensure compliance with device specifications, install the measuring device between the pipe flanges in a way that it is centered in the measurement section.
 3. If using ground disks, comply with the Installation Instructions provided.
 4. Observe required screw tightening torques → 📄 30.
 5. Install the measuring device or turn the transmitter housing so that the cable entries do not point upwards.

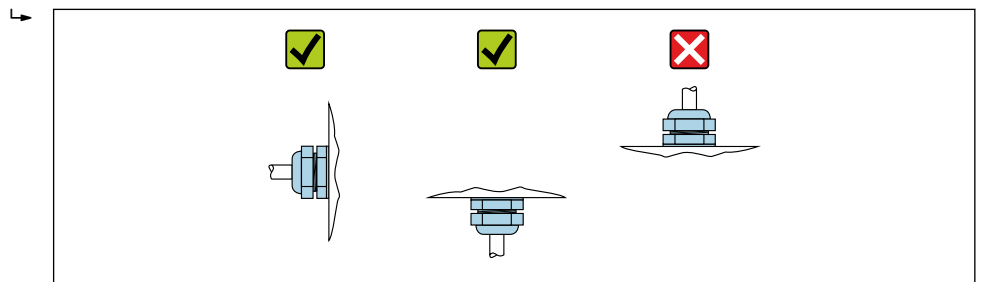

A0029263

Mounting the seals

⚠ CAUTION

An electrically conductive layer could form on the inside of the measuring tube!

Risk of measuring signal short circuit.

- ▶ Do not use electrically conductive sealing compounds such as graphite.

Comply with the following instructions when installing seals:

1. Make sure that the seals do not protrude into the piping cross-section.
2. For DIN flanges: only use seals according to DIN EN 1514-1.
3. For a "hard rubber" liner: additional seals are **always** required.
4. For a "polyurethane" liner: additional seals are generally **not** required.



Mounting the ground cable/ground disks

Comply with the information on potential equalization and detailed mounting instructions for the use of ground cables/ground disks .

Screw tightening torques

Please note the following:

- The screw tightening torques listed below apply only to lubricated threads and to pipes not subjected to tensile stress.
- Tighten the screws uniformly and in diagonally opposite sequence.
- Overtightening the screws will deform the sealing faces or damage the seals.

 Nominal screw tightening torques →  35

Maximum screw tightening torques

Maximum screw tightening torques for EN 1092-1 (DIN 2501)

Nominal diameter		Pressure rating [bar]	Screws [mm]	Flange thickness [mm]	Max. screw tightening torque [Nm]		
[mm]	[in]				HG	PUR	PTFE
25	1	PN 40	4 × M12	18	–	15	26
32	–	PN 40	4 × M16	18	–	24	41
40	1 ½	PN 40	4 × M16	18	–	31	52
50	2	PN 40	4 × M16	20	48	40	65
65 ¹⁾	–	PN 16	8 × M16	18	32	27	44
65	–	PN 40	8 × M16	22	32	27	44
80	3	PN 16	8 × M16	20	40	34	53
		PN 40	8 × M16	24	40	34	53
100	4	PN 16	8 × M16	20	43	36	57
		PN 40	8 × M20	24	59	50	79
125	–	PN 16	8 × M16	22	56	48	75
		PN 40	8 × M24	26	83	71	112
150	6	PN 16	8 × M20	22	74	63	99
		PN 40	8 × M24	28	104	88	137
200	8	PN 10	8 × M20	24	106	91	141
		PN 16	12 × M20	24	70	61	94
		PN 25	12 × M24	30	104	92	139
250	10	PN 10	12 × M20	26	82	71	110
		PN 16	12 × M24	26	98	85	132
		PN 25	12 × M27	32	150	134	201
300	12	PN 10	12 × M20	26	94	81	126
		PN 16	12 × M24	28	134	118	179
		PN 25	16 × M27	34	153	138	204
350	14	PN 6	12 × M20	22	111	120	–
		PN 10	16 × M20	26	112	118	–
		PN 16	16 × M24	30	152	165	–
		PN 25	16 × M30	38	227	252	–
400	16	PN 6	16 × M20	22	90	98	–
		PN 10	16 × M24	26	151	167	–
		PN 16	16 × M27	32	193	215	–
		PN 25	16 × M33	40	289	326	–
450	18	PN 6	16 × M20	22	112	126	–

Nominal diameter		Pressure rating [bar]	Screws [mm]	Flange thickness [mm]	Max. screw tightening torque [Nm]		
[mm]	[in]				HG	PUR	PTFE
		PN 10	20 × M24	28	153	133	-
		PN 16	20 × M27	40	198	196	-
		PN 25	20 × M33	46	256	253	-
500	20	PN 6	20 × M20	24	119	123	-
		PN 10	20 × M24	28	155	171	-
		PN 16	20 × M30	34	275	300	-
		PN 25	20 × M33	48	317	360	-
600	24	PN 6	20 × M24	30	139	147	-
		PN 10	20 × M27	28	206	219	-
600	24	PN 16	20 × M33	36	415	443	-
600	24	PN 25	20 × M36	58	431	516	-
700	28	PN 6	24 × M24	24	148	139	-
		PN 10	24 × M27	30	246	246	-
		PN 16	24 × M33	36	278	318	-
		PN 25	24 × M39	46	449	507	-
800	32	PN 6	24 × M27	24	206	182	-
		PN 10	24 × M30	32	331	316	-
		PN 16	24 × M36	38	369	385	-
		PN 25	24 × M45	50	664	721	-
900	36	PN 6	24 × M27	26	230	637	-
		PN 10	28 × M30	34	316	307	-
		PN 16	28 × M36	40	353	398	-
		PN 25	28 × M45	54	690	716	-
1000	40	PN 6	28 × M27	26	218	208	-
		PN 10	28 × M33	34	402	405	-
		PN 16	28 × M39	42	502	518	-
		PN 25	28 × M52	58	970	971	-
1200	48	PN 6	32 × M30	28	319	299	-
		PN 10	32 × M36	38	564	568	-
		PN 16	32 × M45	48	701	753	-
1400	-	PN 6	36 × M33	32	430	-	-
		PN 10	36 × M39	42	654	-	-
		PN 16	36 × M45	52	729	-	-
1600	-	PN 6	40 × M33	34	440	-	-
		PN 10	40 × M45	46	946	-	-
		PN 16	40 × M52	58	1007	-	-
1800	72	PN 6	44 × M36	36	547	-	-
		PN 10	44 × M45	50	961	-	-
		PN 16	44 × M52	62	1108	-	-
2000	-	PN 6	48 × M39	38	629	-	-
		PN 10	48 × M45	54	1047	-	-

Nominal diameter		Pressure rating [bar]	Screws [mm]	Flange thickness [mm]	Max. screw tightening torque [Nm]		
[mm]	[in]				HG	PUR	PTFE
		PN 16	48 × M56	66	1324	–	–
2200	–	PN 6	52 × M39	42	698	–	–
		PN 10	52 × M52	58	1217	–	–
2400	–	PN 6	56 × M39	44	768	–	–
		PN 10	56 × M52	62	1229	–	–

1) Sizing as per EN 1092-1 (not DIN 2501)

Maximum screw tightening torques for ASME B16.5

Nominal diameter		Pressure rating [psi]	Screws [in]	Max. screw tightening torque			
[mm]	[in]			HG		PUR	
				[Nm]	[lbf · ft]	[Nm]	[lbf · ft]
25	1	Class 150	4 × ½	–	–	7	5
25	1	Class 300	4 × 5/8	–	–	8	6
40	1 ½	Class 150	4 × ½	–	–	10	7
40	1 ½	Class 300	4 × ¾	–	–	15	11
50	2	Class 150	4 × 5/8	35	26	22	16
50	2	Class 300	8 × 5/8	18	13	11	8
80	3	Class 150	4 × 5/8	60	44	43	32
80	3	Class 300	8 × ¾	38	28	26	19
100	4	Class 150	8 × 5/8	42	31	31	23
100	4	Class 300	8 × ¾	58	43	40	30
150	6	Class 150	8 × ¾	79	58	59	44
150	6	Class 300	12 × ¾	70	52	51	38
200	8	Class 150	8 × ¾	107	79	80	59
250	10	Class 150	12 × 7/8	101	74	75	55
300	12	Class 150	12 × 7/8	133	98	103	76
350	14	Class 150	12 × 1	135	100	158	117
400	16	Class 150	16 × 1	128	94	150	111
450	18	Class 150	16 × 1 1/8	204	150	234	173
500	20	Class 150	20 × 1 1/8	183	135	217	160
600	24	Class 150	20 × 1 ¼	268	198	307	226

Maximum screw tightening torques for JIS B2220

Nominal diameter		Pressure rating [bar]	Screws [mm]	Max. screw tightening torque [Nm]	
[mm]				HG	PUR
25		10K	4 × M16	–	19
25		20K	4 × M16	–	19
32		10K	4 × M16	–	22
32		20K	4 × M16	–	22
40		10K	4 × M16	–	24

Nominal diameter [mm]	Pressure rating [bar]	Screws [mm]	Max. screw tightening torque [Nm]	
			HG	PUR
40	20K	4 × M16	–	24
50	10K	4 × M16	40	33
50	20K	8 × M16	20	17
65	10K	4 × M16	55	45
65	20K	8 × M16	28	23
80	10K	8 × M16	29	23
80	20K	8 × M20	42	35
100	10K	8 × M16	35	29
100	20K	8 × M20	56	48
125	10K	8 × M20	60	51
125	20K	8 × M22	91	79
150	10K	8 × M20	75	63
150	20K	12 × M22	81	72
200	10K	12 × M20	61	52
200	20K	12 × M22	91	80
250	10K	12 × M22	100	87
250	20K	12 × M24	159	144
300	10K	16 × M22	74	63
300	20K	16 × M24	138	124

Maximum screw tightening torques for AWWA C207, Class D

Nominal diameter		Screws [in]	Max. screw tightening torque			
[mm]	[in]		HG		PUR	
			[Nm]	[lbf · ft]	[Nm]	[lbf · ft]
700	28	28 × 1 ¼	247	182	292	215
750	30	28 × 1 ¼	287	212	302	223
800	32	28 × 1 ½	394	291	422	311
900	36	32 × 1 ½	419	309	430	317
1000	40	36 × 1 ½	420	310	477	352
–	42	36 × 1 ½	528	389	518	382
–	48	44 × 1 ½	552	407	531	392
–	54	44 × 1 ¾	730	538	–	–
–	60	52 × 1 ¾	758	559	–	–
–	66	52 × 1 ¾	946	698	–	–
–	72	60 × 1 ¾	975	719	–	–
–	78	64 × 2	853	629	–	–
–	84	64 × 2	931	687	–	–
–	90	64 × 2 ¼	1048	773	–	–

Maximum screw tightening torques for AS 2129, Table E

Nominal diameter [mm]	Screws [mm]	Max. screw tightening torque [Nm]	
		HG	PUR
50	4 × M16	32	-
80	4 × M16	49	-
100	8 × M16	38	-
150	8 × M20	64	-
200	8 × M20	96	-
250	12 × M20	98	-
300	12 × M24	123	-
350	12 × M24	203	-
400	12 × M24	226	-
450	16 × M24	226	-
500	16 × M24	271	-
600	16 × M30	439	-
700	20 × M30	355	-
750	20 × M30	559	-
800	20 × M30	631	-
900	24 × M30	627	-
1000	24 × M30	634	-
1200	32 × M30	727	-

Maximum screw tightening torques for AS 4087, PN 16

Nominal diameter [mm]	Screws [mm]	Max. screw tightening torque [Nm]	
		HG	PUR
50	4 × M16	32	-
80	4 × M16	49	-
100	4 × M16	76	-
150	8 × M20	52	-
200	8 × M20	77	-
250	8 × M20	147	-
300	12 × M24	103	-
350	12 × M24	203	-
375	12 × M24	137	-
400	12 × M24	226	-
450	12 × M24	301	-
500	16 × M24	271	-
600	16 × M27	393	-
700	20 × M27	330	-
750	20 × M30	529	-
800	20 × M33	631	-
900	24 × M33	627	-

Nominal diameter [mm]	Screws [mm]	Max. screw tightening torque [Nm]	
		HG	PUR
1000	24 × M33	595	–
1200	32 × M33	703	–

Nominal screw tightening torques

Nominal screw tightening torques for EN 1092-1 (DIN 2501); calculated according to EN 1591-1:2014 for flanges according to EN 1092-1:2013

Nominal diameter		Pressure rating [bar]	Screws [mm]	Flange thickness [mm]	Nom. screw tightening torque [Nm]		
[mm]	[in]				HG	PUR	PTFE
1000	40	PN 6	28 × M27	38	175	185	–
		PN 10	28 × M33	44	350	360	–
		PN 16	28 × M39	59	630	620	–
		PN 25	28 × M52	63	1300	1290	–
1200	48	PN 6	32 × M30	42	235	250	–
		PN 10	32 × M36	55	470	480	–
		PN 16	32 × M45	78	890	900	–
1400	–	PN 6	36 × M33	56	300	–	–
		PN 10	36 × M39	65	600	–	–
		PN 16	36 × M45	84	1050	–	–
1600	–	PN 6	40 × M33	63	340	–	–
		PN 10	40 × M45	75	810	–	–
		PN 16	40 × M52	102	1420	–	–
1800	72	PN 6	44 × M36	69	430	–	–
		PN 10	44 × M45	85	920	–	–
		PN 16	44 × M52	110	1600	–	–
2000	–	PN 6	48 × M39	74	530	–	–
		PN 10	48 × M45	90	1040	–	–
		PN 16	48 × M56	124	1900	–	–
2200	–	PN 6	52 × M39	81	580	–	–
		PN 10	52 × M52	100	1290	–	–
2400	–	PN 6	56 × M39	87	650	–	–
		PN 10	56 × M52	110	1410	–	–

Nominal screw tightening torques for JIS B2220

Nominal diameter [mm]	Pressure rating [bar]	Screws [mm]	Nom. screw tightening torque [Nm]	
			HG	PUR
350	10K	16 × M22	109	109
	20K	16 × M30×3	217	217
400	10K	16 × M24	163	163
	20K	16 × M30×3	258	258
450	10K	16 × M24	155	155

Nominal diameter [mm]	Pressure rating [bar]	Screws [mm]	Nom. screw tightening torque [Nm]	
			HG	PUR
	20K	16 × M30×3	272	272
500	10K	16 × M24	183	183
	20K	16 × M30×3	315	315
600	10K	16 × M30	235	235
	20K	16 × M36×3	381	381
700	10K	16 × M30	300	300
750	10K	16 × M30	339	339

6.2.4 Mounting the transmitter of the remote version

⚠ CAUTION

Ambient temperature too high!

Danger of electronics overheating and housing deformation.

- ▶ Do not exceed the permitted maximum ambient temperature .
- ▶ If operating outdoors: Avoid direct sunlight and exposure to weathering, particularly in warm climatic regions.

⚠ CAUTION

Excessive force can damage the housing!

- ▶ Avoid excessive mechanical stress.

The transmitter of the remote version can be mounted in the following ways:

- Wall mounting
- Pipe mounting

Wall mounting

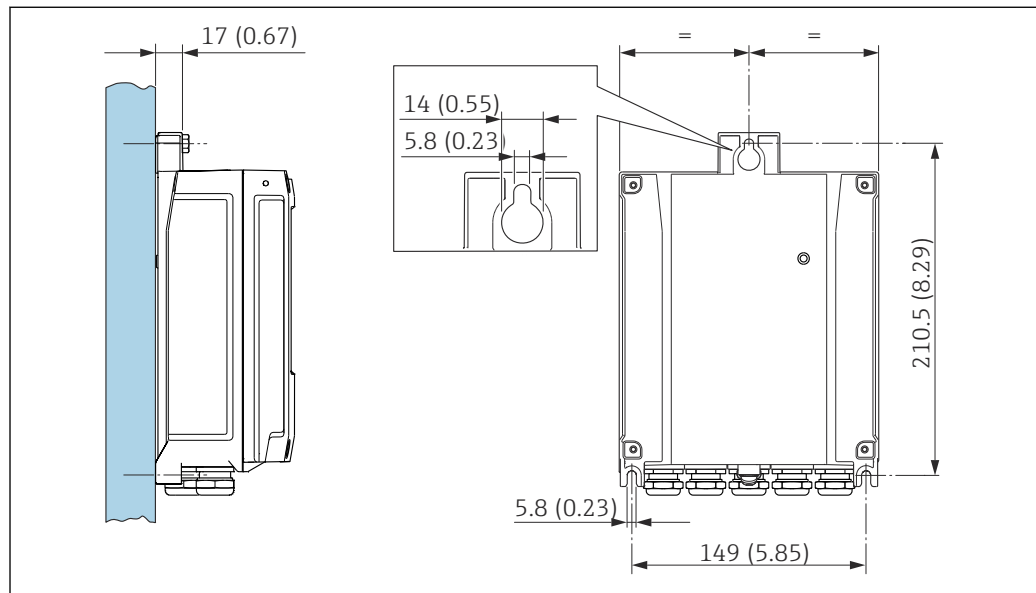

4 Engineering unit mm (in)

1. Drill the holes.
2. Insert wall plugs into the drilled holes.
3. Screw the securing screws in slightly.

4. Fit the transmitter housing over the securing screws and mount in place.
5. Tighten the securing screws.

Post mounting

⚠ WARNING

Excessive tightening torque applied to the fixing screws!

Risk of damaging the plastic transmitter.

- ▶ Tighten the fixing screws as per the tightening torque: 2 Nm (1.5 lbf ft)

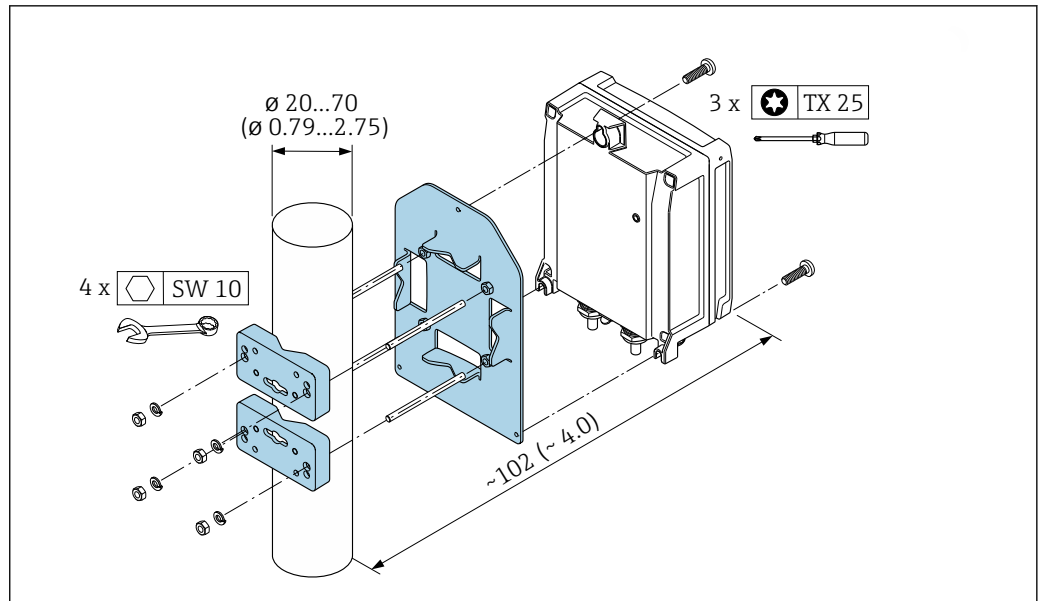

A0029051

5 Engineering unit mm (in)

6.2.5 Turning the transmitter housing

To provide easier access to the connection compartment or display module, the transmitter housing can be turned.

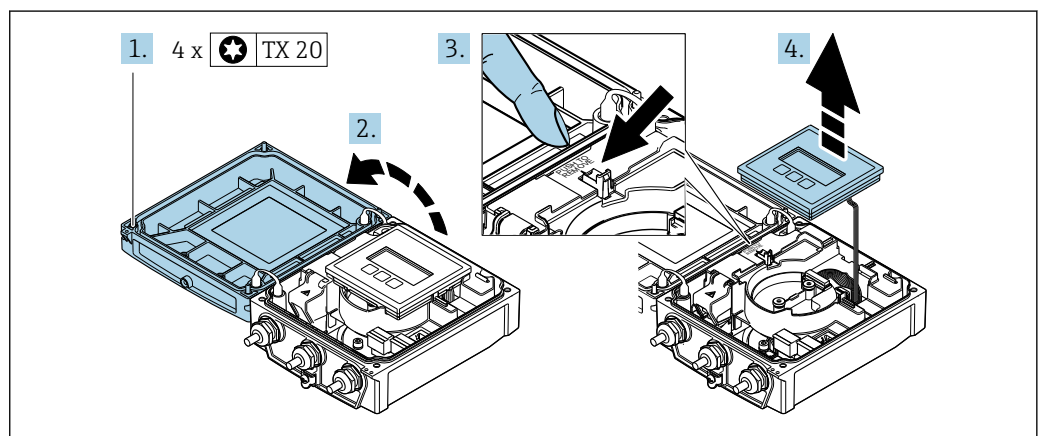

A0032086

1. Loosen the fixing screws of the housing cover (when reassembling, pay attention to the tightening torque → 39).
2. Open the housing cover.
3. Unlock the display module.
4. Remove the display module.

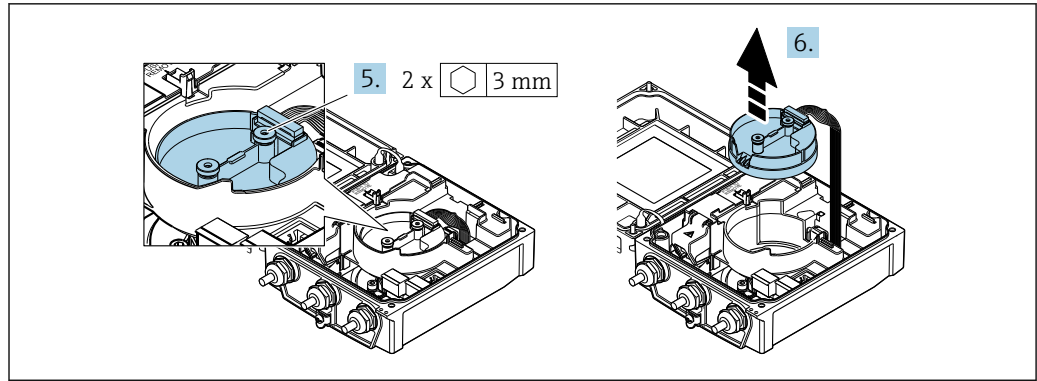

A0032087

5. Loosen the fixing screws of the smart sensor electronics module (when reassembling, pay attention to the tightening torque → 39).
6. Remove the smart sensor electronics module (when reassembling, pay attention to the coding of the plug → 39).

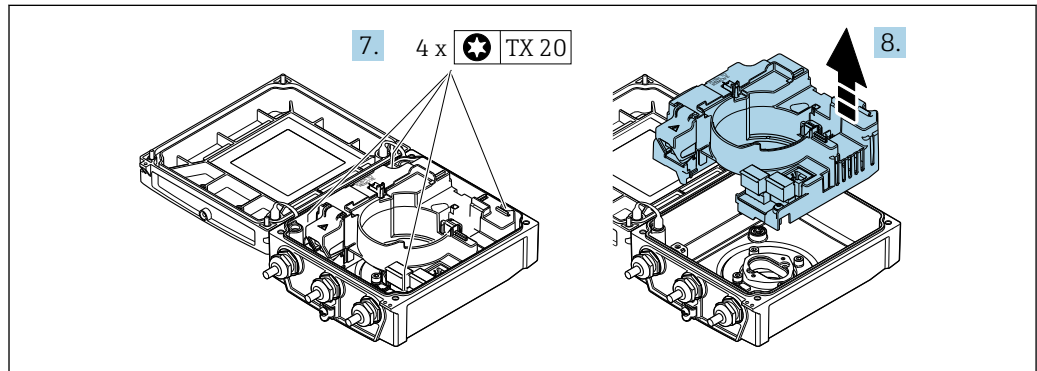

A0032088

7. Loosen the fixing screws of the main electronics module (when reassembling, pay attention to the tightening torque → 39).
8. Remove the main electronics module.

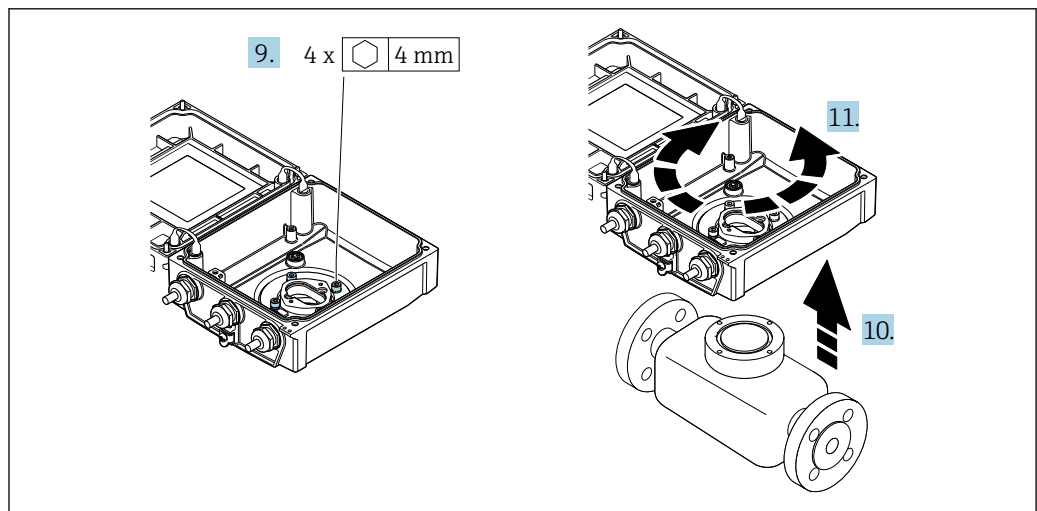

A0032089

9. Loosen the fixing screws of the transmitter housing (when reassembling, pay attention to the tightening torque → 39).
10. Lift the transmitter housing.
11. Turn the housing to the desired position in increments of 90°.

Reassembling the transmitter housing

⚠ WARNING

Excessive tightening torque applied to the fixing screws!

Risk of damaging the plastic transmitter.

- ▶ Tighten the fixing screws as per the tightening torque: 2 Nm (1.5 lbf ft)

Step → 37	Fixing screw	Tightening torques for housing made of:	
		Aluminum	Plastic
1	Housing cover	2.5 Nm (1.8 lbf ft)	1 Nm (0.7 lbf ft)
5	Smart sensor electronics module	0.6 Nm (0.4 lbf ft)	
7	Main electronics module	1.5 Nm (1.1 lbf ft)	
9/10	Transmitter housing	5.5 Nm (4.1 lbf ft)	

NOTICE

Plug of the smart sensor electronics module connected incorrectly!

No measuring signal is output.

- ▶ Plug in the plug of the smart sensor electronics module as per the coding.

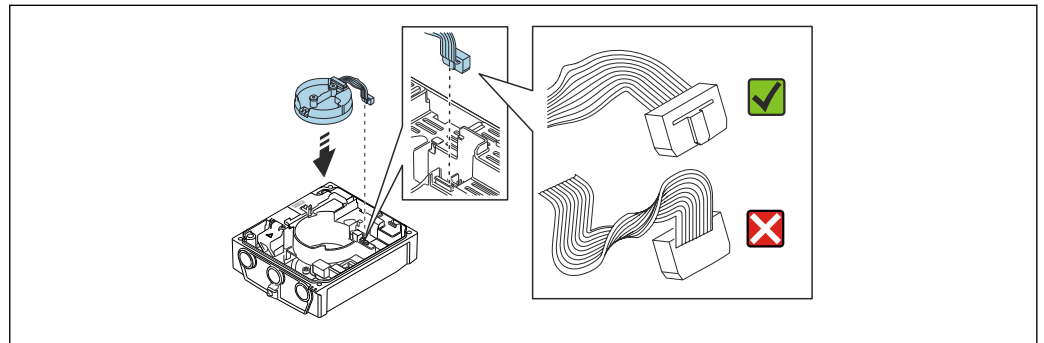

A0021585

- ▶ Reverse the procedure to reassemble the measuring device.

6.2.6 Turning the display module

The display module can be turned to optimize display readability and operability.

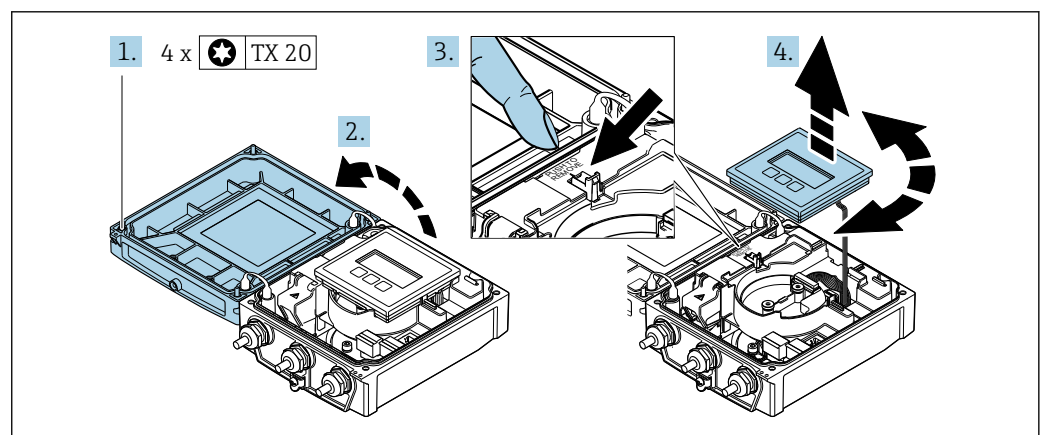

A0032091

1. Loosen the fixing screws of the housing cover.
2. Open the housing cover.
3. Unlock the display module.
4. Pull out the display module and turn it to the desired position in increments of 90°.

Mounting the transmitter housing

⚠ WARNING

Excessive tightening torque applied to the fixing screws!

Damage to the transmitter.

- ▶ Tighten the fixing screws with the specified torques.

1. Insert the display module and lock it when doing so.
2. Close the housing cover.
3. Tighten the fixing screws of the housing cover: tightening torque for aluminum housing 2.5 Nm (1.8 lbf ft) – plastic housing 1 Nm (0.7 lbf ft).

6.3 Post-installation check

Is the device undamaged (visual inspection)?	<input type="checkbox"/>
Does the measuring device conform to the measuring point specifications? For example: <ul style="list-style-type: none"> ▪ Process temperature → 187 ▪ Process pressure (refer to the section on "Pressure-temperature ratings" in the "Technical Information" document) → 204 ▪ Ambient temperature → 25 ▪ Measuring range → 174 	<input type="checkbox"/>
Has the correct orientation been selected for the sensor → 21 ? <ul style="list-style-type: none"> ▪ According to sensor type ▪ According to medium temperature ▪ According to medium properties (outgassing, with entrained solids) 	<input type="checkbox"/>
Does the arrow on the sensor nameplate match the actual direction of flow of the fluid through the piping → 21?	<input type="checkbox"/>
Are the measuring point identification and labeling correct (visual inspection)?	<input type="checkbox"/>
Is the device adequately protected from precipitation and direct sunlight?	<input type="checkbox"/>
Have the fixing screws been tightened with the correct tightening torque?	<input type="checkbox"/>

7 Electrical connection

NOTICE

The measuring device does not have an internal circuit breaker.

- ▶ For this reason, assign the measuring device a switch or power-circuit breaker so that the power supply line can be easily disconnected from the mains.
- ▶ Although the measuring device is equipped with a fuse, additional overcurrent protection (maximum 16 A) should be integrated into the system installation.

7.1 Electrical safety

In accordance with applicable national regulations.

7.2 Connection conditions

7.2.1 Required tools

- Torque wrench
- For cable entries: Use corresponding tools
- Wire stripper
- When using stranded cables: Crimper for wire end ferrule

7.2.2 Requirements for connecting cable

The connecting cables provided by the customer must fulfill the following requirements.

Permitted temperature range

- The installation guidelines that apply in the country of installation must be observed.
- The cables must be suitable for the minimum and maximum temperatures to be expected.

Power supply cable (incl. conductor for the inner ground terminal)

Standard installation cable is sufficient.

Signal cable

PROFIBUS DP

The IEC 61158 standard specifies two types of cable (A and B) for the bus line which can be used for every transmission rate. Cable type A is recommended.

Cable type	A
Characteristic impedance	135 to 165 Ω at a measuring frequency of 3 to 20 MHz
Cable capacitance	< 30 pF/m
Wire cross-section	> 0,34 mm ² (22 AWG)
Cable type	Twisted pairs
Loop resistance	≤110 Ω /km

Signal damping	Max. 9 dB over the entire length of the cable cross-section
Shield	Copper braided shielding or braided shielding with foil shield. When grounding the cable shield, observe the grounding concept of the plant.



For further information on planning and installing PROFIBUS networks see:

Operating Instructions "PROFIBUS DP/PA: Guidelines for planning and commissioning" (BA00034S)

Connecting cable for remote version

Electrode cable

Standard cable	3 × 0.38 mm ² (20 AWG) with common, braided copper shield (ϕ ~9.5 mm (0.37 in)) and individual shielded cores
Cable for empty pipe detection (EPD)	4 × 0.38 mm ² (20 AWG) with common, braided copper shield (ϕ ~9.5 mm (0.37 in)) and individual shielded cores
Conductor resistance	≤ 50 Ω/km (0.015 Ω/ft)
Capacitance: core/shield	≤ 420 pF/m (128 pF/ft)
Operating temperature	-20 to +80 °C (-4 to +176 °F)

Coil current cable

Standard cable	3 × 0.75 mm ² (18 AWG) with common, braided copper shield (ϕ ~9 mm (0.35 in))
Conductor resistance	≤ 37 Ω/km (0.011 Ω/ft)
Capacitance: core/core, shield grounded	≤ 120 pF/m (37 pF/ft)
Operating temperature	-20 to +80 °C (-4 to +176 °F)
Test voltage for cable insulation	≤ AC 1433 V rms 50/60 Hz or ≥ DC 2026 V

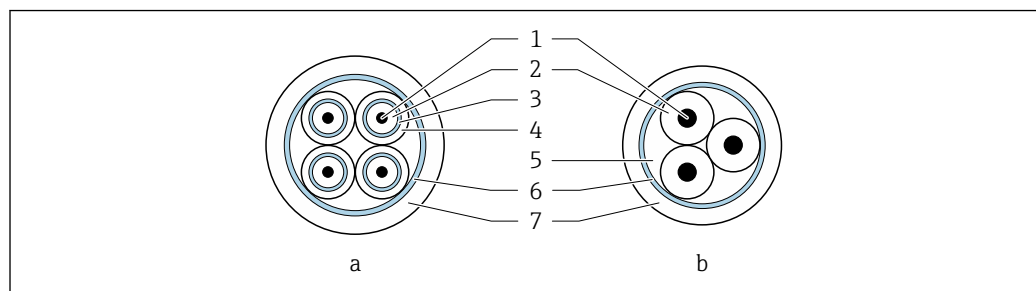

A0029151

6 Cable cross-section



- a Electrode cable
- b Coil current cable
- 1 Core
- 2 Core insulation
- 3 Core shield
- 4 Core jacket
- 5 Core reinforcement
- 6 Cable shield
- 7 Outer jacket

Armored connecting cable

Armored connecting cables with an additional, reinforcing metal braid should be used:

- When laying the cable directly in the ground
- Where there is a risk of damage from rodents
- Use as per IP68 degree of protection

Operation in environments with strong electrical interference

The measuring system meets the general safety requirements →  203 and EMC specifications →  186.

Grounding is by means of the ground terminal provided for the purpose inside the connection housing. The stripped and twisted lengths of cable shield to the ground terminal must be as short as possible.

Cable diameter

- Cable glands supplied:
 - For standard cable: M20 × 1.5 with cable ϕ 6 to 12 mm (0.24 to 0.47 in)
 - For reinforced cable: M20 × 1.5 with cable ϕ 9.5 to 16 mm (0.37 to 0.63 in)
- (Plug-in) spring terminals for wire cross-sections 0.5 to 2.5 mm² (20 to 14 AWG)

7.2.3 Terminal assignment

Transmitter

The sensor can be ordered with terminals.

Connection methods available		Possible options for order code "Electrical connection"
Outputs	Power supply	
Terminals	Terminals	<ul style="list-style-type: none"> ■ Option A: coupling M20x1 ■ Option B: thread M20x1 ■ Option C: thread G 1/2" ■ Option D: thread NPT 1/2"

Supply voltage

Order code "Power supply"	Terminal numbers	terminal voltage		Frequency range
Option L (wide range power unit)	1 (L+/L), 2 (L-/N)	DC 24 V	±25%	–
		AC 24 V	±25%	50/60 Hz, ±4 Hz
		AC 100 to 240 V	–15 to +10%	50/60 Hz, ±4 Hz

PROFIBUS DP signal transmission

Order code for "Output" and "Input"	Terminal numbers	
	26 (RxD/TxD-P)	27 (RxD/TxD-N)
Option L	B	A
Order code for "Output": Option L: PROFIBUS DP, for use in non-hazardous areas and Zone 2/Div. 2		

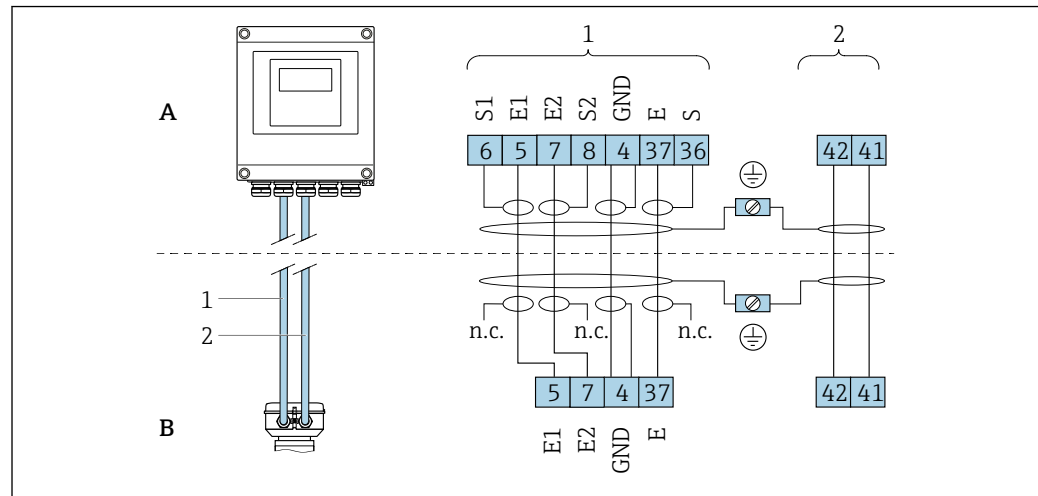
Remote version

7 Remote version terminal assignment

- A Transmitter wall-mount housing
 B Sensor connection housing
 1 Electrode cable
 2 Coil current cable
 n.c. Not connected, insulated cable shields

Terminal No. and cable colors: 6/5 = brown; 7/8 = white; 4 = green; 36/37 = yellow

7.2.4 Shielding and grounding

Optimal electromagnetic compatibility (EMC) of the fieldbus system can be guaranteed only if the system components and, in particular, the lines are shielded and the shield forms as complete a cover as possible. A shield coverage of 90 % is ideal.

1. To ensure optimal EMC protection, connect the shield to the reference ground as often as possible.
2. For reasons concerning explosion protection, it is recommended that grounding be dispensed with.

To comply with both requirements, there are basically three different types of shielding in the fieldbus system:

- Shielding at both ends
- Shielding at one end on the feed side with capacitance termination at the field device
- Shielding at one end on the feed side

Experience shows that the best results with regard to EMC are achieved in most cases in installations with one-sided shielding on the feed side (without capacitance termination at the field device). Appropriate measures with regard to input wiring must be taken to allow unrestricted operation when EMC interference is present. These measures have been taken into account for this device. Operation in the event of disturbance variables as per NAMUR NE21 is thus guaranteed.

1. Observe national installation requirements and guidelines during installation.
2. Where there are large differences in potential between the individual grounding points, connect only one point of the shielding directly to the reference ground.
3. In systems without potential equalization, the cable shielding of fieldbus systems should be grounded on one side only, for example at the fieldbus supply unit or at safety barriers.

NOTICE

In systems without potential matching, the multiple grounding of the cable shield causes mains frequency equalizing currents!

Damage to the bus cable shield.

- ▶ Only ground the bus cable shield to either the local ground or the protective ground at one end.
- ▶ Insulate the shield that is not connected.

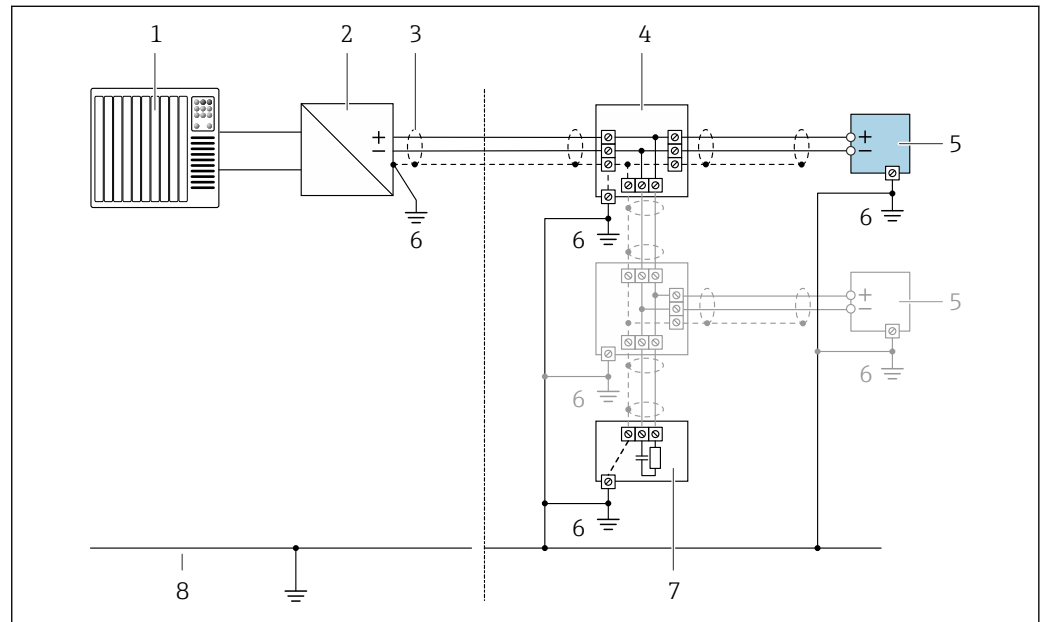

8 Connection example for PROFIBUS DP

- 1 Control system (e.g. PLC)
- 2 PROFIBUS DP segment coupler
- 3 Cable shield: the cable shield must be grounded at both ends to comply with EMC requirements; observe cable specifications
- 4 T-box
- 5 Measuring device
- 6 Local grounding
- 7 Bus terminator
- 8 Potential equalization conductor

7.2.5 Preparing the measuring device

Carry out the steps in the following order:

1. Mount the sensor and transmitter.
2. Connection housing, sensor: Connect connecting cable.
3. Transmitter: Connect connecting cable.
4. Transmitter: Connect signal cable and cable for supply voltage.

NOTICE

Insufficient sealing of the housing!

Operational reliability of the measuring device could be compromised.

- ▶ Use suitable cable glands corresponding to the degree of protection.

1. Remove dummy plug if present.
2. If the measuring device is supplied without cable glands:
Provide suitable cable gland for corresponding connecting cable.
3. If the measuring device is supplied with cable glands:
Observe requirements for connecting cables → 41.

7.2.6 Preparing the connecting cable for the remote version

When terminating the connecting cable, pay attention to the following points:

1. In the case of the electrode cable:
Make sure that the ferrules do not touch the core shields on the sensor side.
Minimum distance = 1 mm (exception: green "GND" cable)
2. In the case of the coil current cable:
Insulate one core of the three-core cable at the level of the core reinforcement. You only require two cores for the connection.
3. For cables with fine-wire cores (stranded cables):
Fit the cores with ferrules.

Transmitter

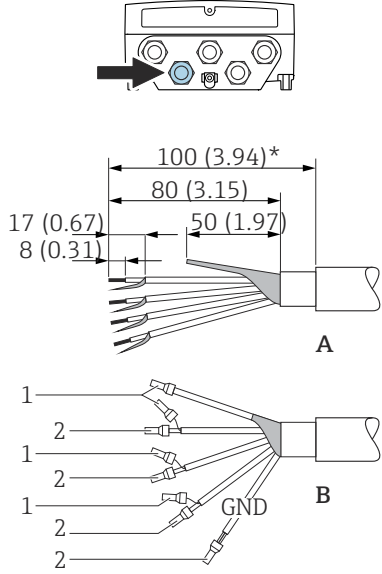
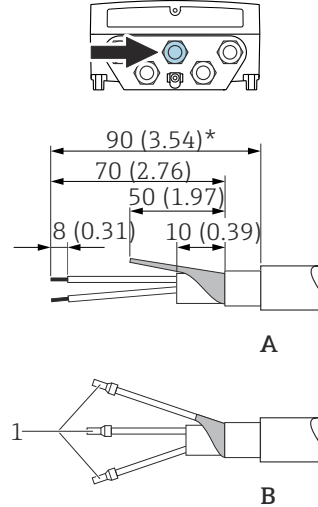
Electrode cable	Coil current cable
 <p style="text-align: center;">Engineering unit mm (in)</p> <p style="text-align: right;">A0032093</p>	 <p style="text-align: center;">Engineering unit mm (in)</p> <p style="text-align: right;">A0032096</p>
<p>A = Termination of the cables B = Termination of the fine-wire cores with ferrules 1 = Red ferrules, ϕ 1.0 mm (0.04 in) 2 = White ferrules, ϕ 0.5 mm (0.02 in) * = Stripping only for reinforced cables</p>	

Sensor

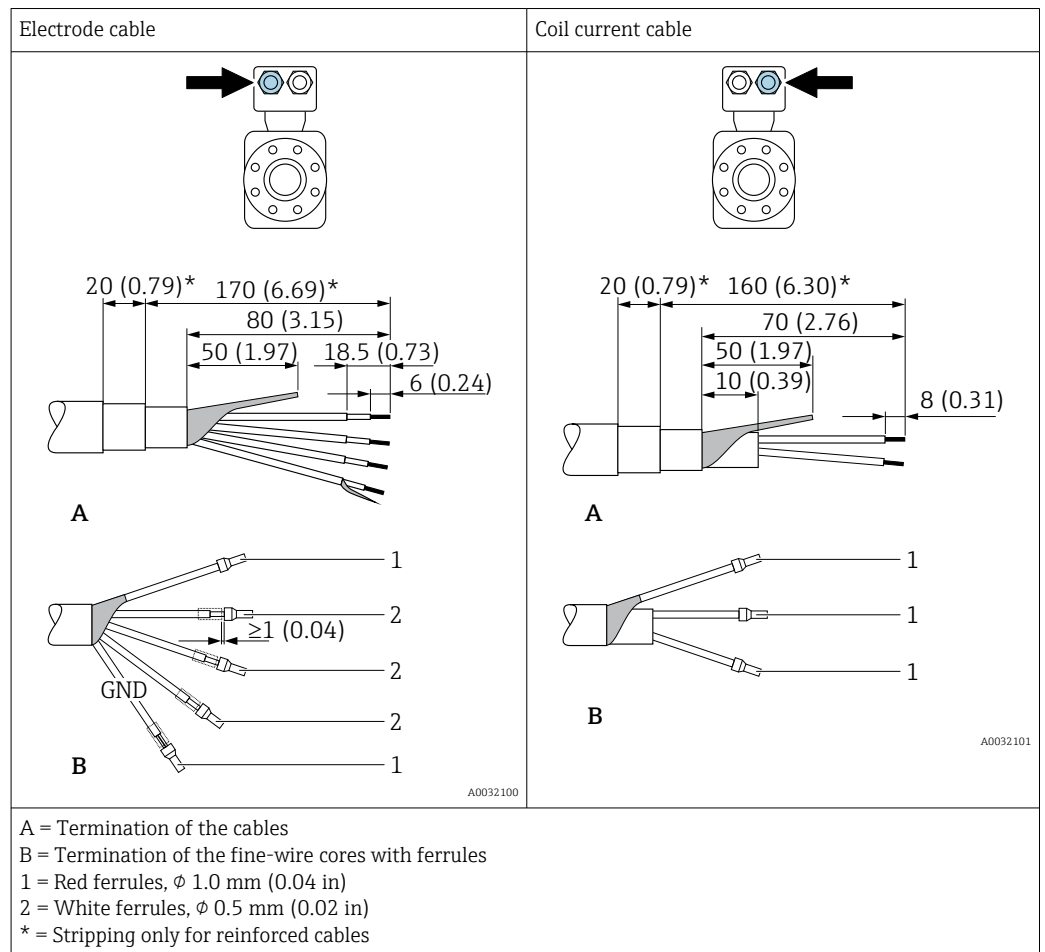

7.3 Connecting the measuring device

⚠ WARNING

Risk of electric shock! Components carry dangerous voltages!

- ▶ Have electrical connection work carried out by correspondingly trained specialists only.
- ▶ Observe applicable federal/national installation codes and regulations.
- ▶ Comply with local workplace safety regulations.
- ▶ Observe grounding concept of the plant.
- ▶ Never mount or wire the measuring device while it is connected to the supply voltage.
- ▶ Before the supply voltage is applied, connect the protective ground to the measuring device.

7.3.1 Connecting the remote version

⚠ WARNING

Risk of damaging the electronic components!

- ▶ Connect the sensor and transmitter to the same potential equalization.
- ▶ Only connect the sensor to a transmitter with the same serial number.
- ▶ Ground the connection housing of the sensor via the external screw terminal.

The following procedure (in the action sequence given) is recommended for the remote version:

1. Mount the sensor and transmitter.
2. Connect the connecting cable for the remote version.

3. Connect the transmitter.

Connecting the connecting cable to the sensor connection housing

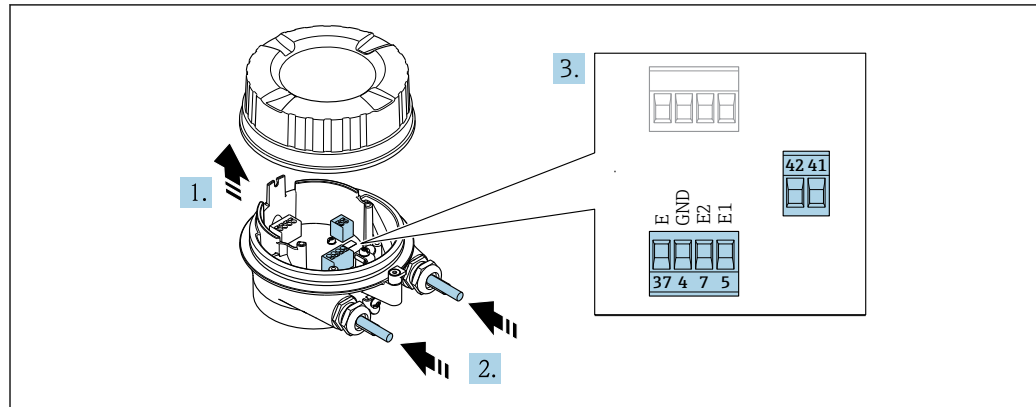

11 Sensor: connection module

1. Loosen the securing clamp of the housing cover.
2. Unscrew and lift off the housing cover.
3. **NOTICE**

For conduit extensions:

- ▶ Fit O-ring on cable and push it back sufficiently. When inserting the cable, the O-ring must be located outside the conduit extension.

Push the cable through the cable entry. To ensure tight sealing, do not remove the sealing ring from the cable entry.

4. Strip the cable and cable ends. In the case of stranded cables, also fit ferrules → 46.
5. Connect the cable in accordance with the terminal assignment → 44.
6. Firmly tighten the cable glands.
7. **WARNING**

Housing degree of protection may be voided due to insufficient sealing of the housing.

- ▶ Screw in the screw without using any lubricant. The threads on the cover are coated with a dry lubricant.

Reverse the procedure to reassemble the sensor.

Connecting the connecting cable to the transmitter

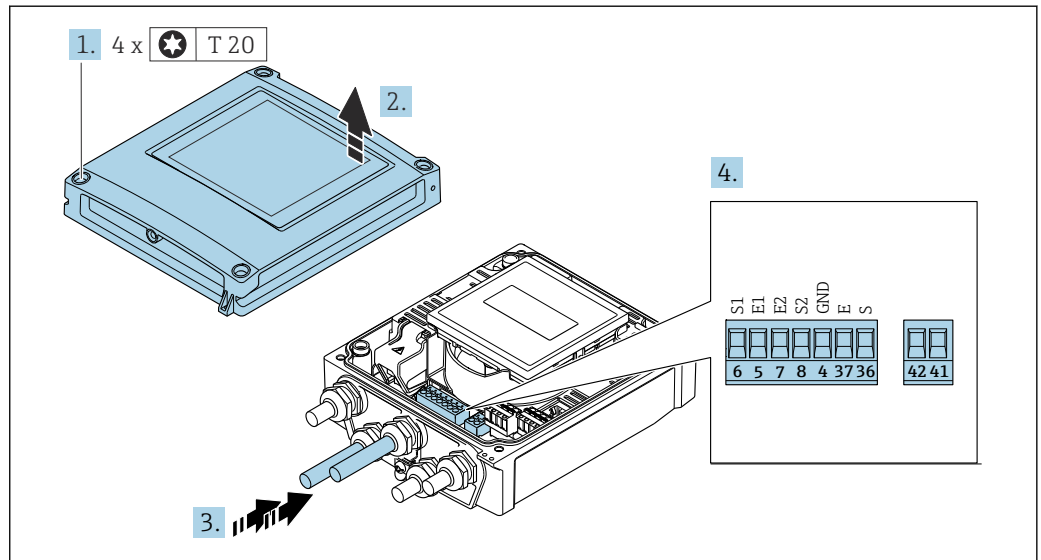

A0032102

12 Transmitter: main electronics module with terminals

1. Loosen the 4 fixing screws on the housing cover.
2. Open the housing cover.
3. Push the cable through the cable entry. To ensure tight sealing, do not remove the sealing ring from the cable entry.
4. Strip the cable and cable ends. In the case of stranded cables, also fit ferrules → 46.
5. Connect the cable in accordance with the terminal assignment → 44.
6. Firmly tighten the cable glands.
7. **⚠ WARNING**

Housing degree of protection may be voided due to insufficient sealing of the housing.

- ▶ Screw in the screw without using any lubricant.

Reverse the removal procedure to reassemble the transmitter.

7.3.2 Connecting the transmitter

⚠ WARNING

Housing degree of protection may be voided due to insufficient sealing of the housing.

- Screw in the screw without using any lubricant. The threads on the cover are coated with a dry lubricant.

Tightening torques for plastic housing

Housing cover fixing screw	1 Nm (0.7 lbf ft)
Cable entry	5 Nm (3.7 lbf ft)
Ground terminal	2.5 Nm (1.8 lbf ft)

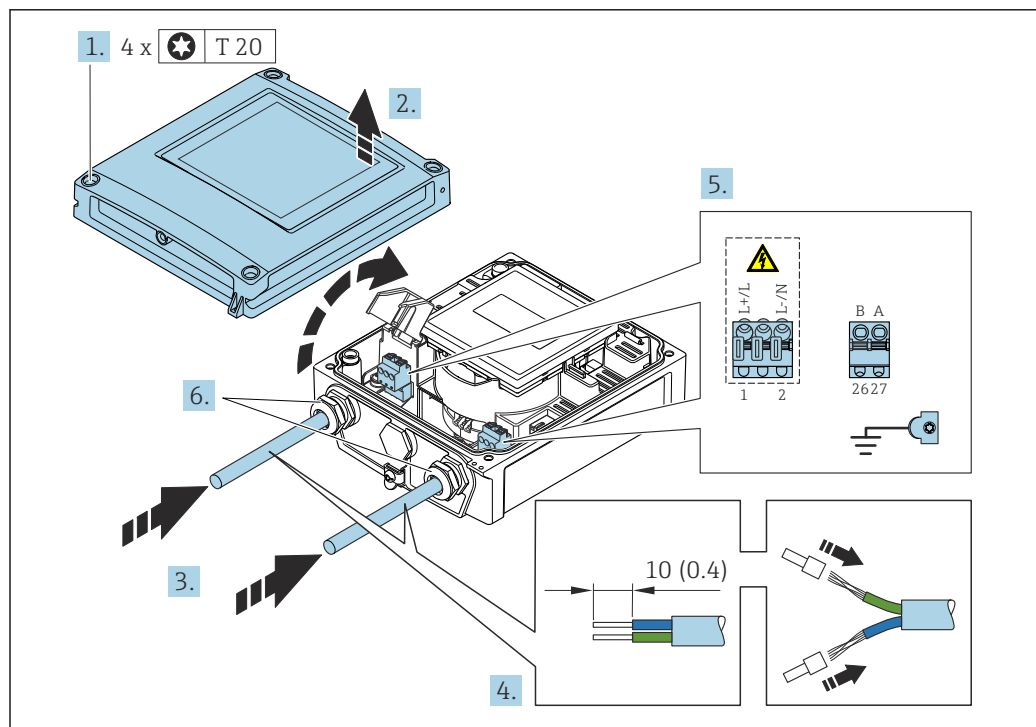

13 Connecting the supply voltage and PROFIBUS DP

1. Loosen the 4 fixing screws on the housing cover.
2. Open the housing cover.
3. Push the cable through the cable entry. To ensure tight sealing, do not remove the sealing ring from the cable entry.
4. Strip the cable and cable ends. In the case of stranded cables, also fit ferrules.
5. Connect the cables according to the terminal assignment → 43. For supply voltage: open the shock protection cover.
6. Firmly tighten the cable glands.

Reassembling the transmitter

1. Close the shock protection cover.
2. Close the housing cover.

3. ⚠ WARNING

Housing degree of protection may be voided due to insufficient sealing of the housing.

- ▶ Screw in the screw without using any lubricant.

Tighten the 4 fixing screws on the housing cover.



7.3.3 Ensuring potential equalization

Introduction

Correct potential equalization (equipotential bonding) is a prerequisite for stable and reliable flow measurement. Inadequate or incorrect potential equalization can result in device failure and present a safety hazard.

The following requirements must be observed to ensure correct, trouble-free measurement:

- The principle that the medium, the sensor and the transmitter must be at the same electrical potential applies.
- Take in-company grounding guidelines, materials and the grounding conditions and potential conditions of the pipe into consideration.
- Any necessary potential equalization connections must be established by ground cables with a minimum cross-section of 6 mm² (0.0093 in²).
- For remote device versions, the ground terminal in the example always refers to the sensor and not to the transmitter.

 You can order accessories like ground cables and ground disks from Endress+Hauser →  171

 For devices intended for use in hazardous locations, observe the instructions in the Ex documentation (XA).

Abbreviations used

- PE (Protective Earth): potential at the protective earth terminals of the device
- P_P (Potential Pipe): potential of the pipe, measured at the flanges
- P_M (Potential Medium): potential of the medium

Connection examples for standard situations

Unlined and grounded metal pipe

- Potential equalization is via the measuring pipe.
- The medium is set to ground potential.

Starting conditions:

- Pipes are correctly grounded on both sides.
- Pipes are conductive and at the same electrical potential as the medium

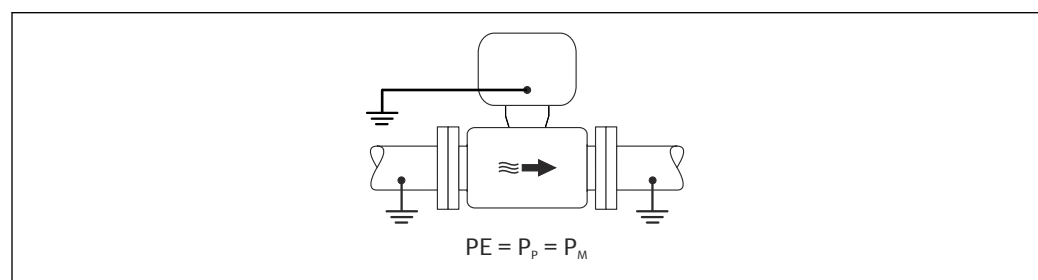

A0044854

- ▶ Connect the connection housing of the transmitter or sensor to ground potential by means of the ground terminal provided for this purpose.

Unlined metal pipe

- Potential equalization is via the ground terminal and pipe flanges.
- The medium is set to ground potential.

Starting conditions:

- Pipes are not sufficiently grounded.
- Pipes are conductive and at the same electrical potential as the medium

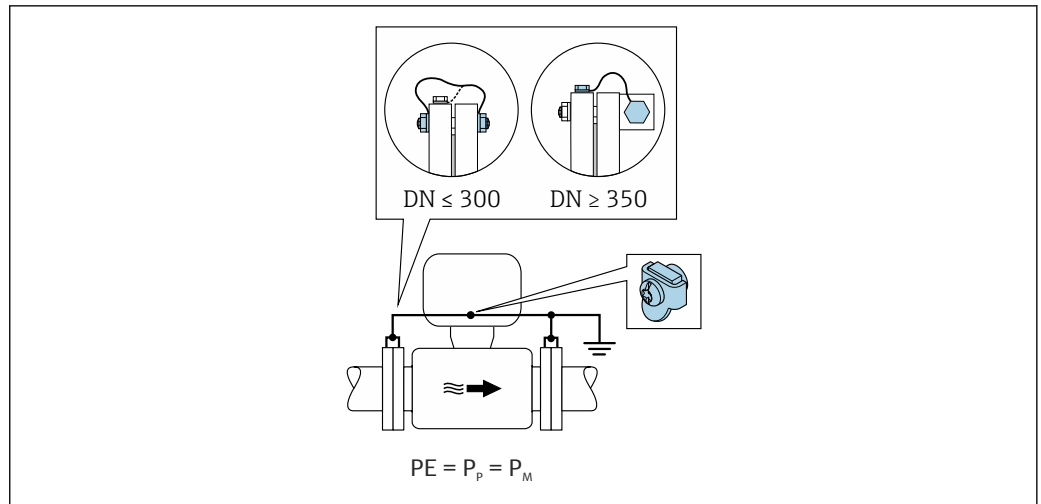

A0042089

1. Connect both sensor flanges to the pipe flange via a ground cable and ground them.
 2. Connect the connection housing of the transmitter or sensor to ground potential by means of the ground terminal provided for this purpose.
- i** ■ For DN ≤ 300 (12"): Mount the ground cable directly on the conductive flange coating of the sensor with the flange screws.
- For DN ≥ 350 (14"): Mount the ground cable directly on the metal transport bracket. Observe screw tightening torques: see the Brief Operating Instructions for the sensor.

Plastic pipe or pipe with insulating liner

- Potential equalization is via the ground terminal and ground disks.
- The medium is set to ground potential.

Starting conditions:

- The pipe has an insulating effect.
- Low-impedance medium grounding close to the sensor is not guaranteed.
- Equalizing currents through the medium cannot be ruled out.

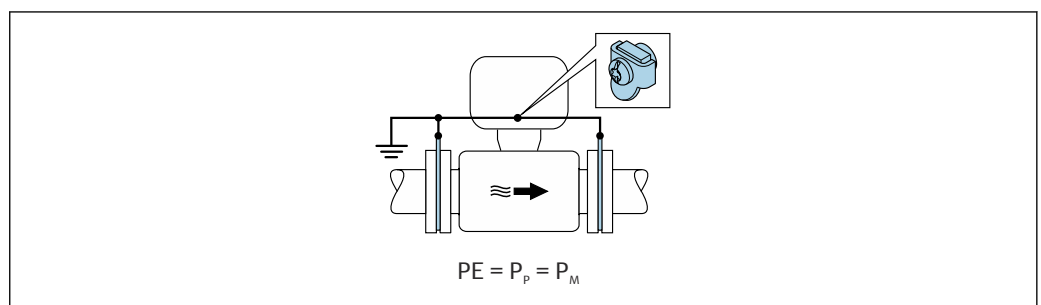

A0044856

1. Connect the ground disks to the ground terminal of the connection housing of the transmitter or sensor via the ground cable.
2. Connect the connection to ground potential.

Connection example with the potential of the medium not equal to the protective ground

In these cases, the medium potential can differ from the potential of the device.

Metal, ungrounded pipe

The sensor and transmitter are installed in a way that provides electrical insulation from PE, e.g. applications for electrolytic processes or systems with cathodic protection.

Starting conditions:

- Unlined metal pipe
- Pipes with an electrically conductive liner

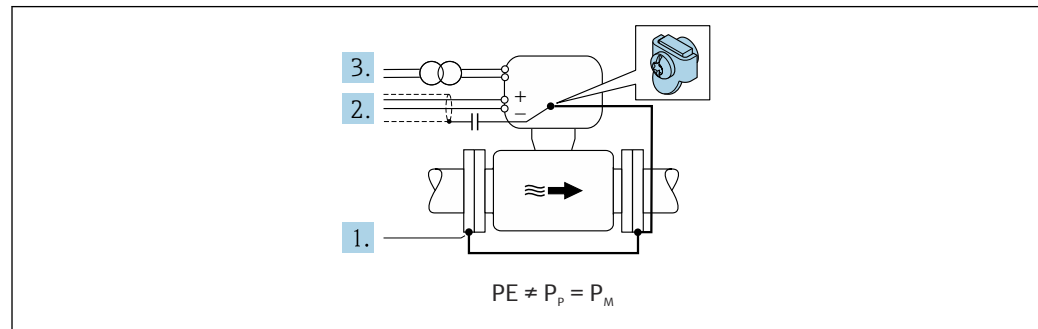

1. Connect the pipe flanges and transmitter via the ground cable.
2. Route the shielding of the signal lines via a capacitor (recommended value 1.5µF/50V).
3. Device connected to power supply such that it is floating in relation to the protective earth (isolation transformer). This measure is not required in the case of 24V DC supply voltage without PE (= SELV power unit).

Connection examples with the potential of medium not equal to protective earth with the "Measurement isolated from ground" option

In these cases, the medium potential can differ from the potential of the device.

Introduction

The "Measurement isolated from ground" option enables the galvanic isolation of the measuring system from the device potential. This minimizes harmful equalizing currents caused by differences in potential between the medium and the device. The "Measurement isolated from ground" option is optionally available: order code for "Sensor option", option CV

Operating conditions for the use of the "Measurement isolated from ground" option

Device version	Compact version and remote version (length of connecting cable ≤ 10 m)
Differences in voltage between medium potential and device potential	As small as possible, usually in the mV range
Alternating voltage frequencies in the medium or at ground potential (PE)	Below typical power line frequency in the country

- i** To achieve the specified conductivity measuring accuracy, a conductivity calibration is recommended when the device is installed.

A full pipe adjustment is recommended when the device is installed.

Plastic pipe

Sensor and transmitter are correctly grounded. A difference in potential can occur between the medium and protective earth. Potential equalization between P_M and PE via the reference electrode is minimized with the "Measurement isolated from ground" option.

Starting conditions:

- The pipe has an insulating effect.
- Equalizing currents through the medium cannot be ruled out.

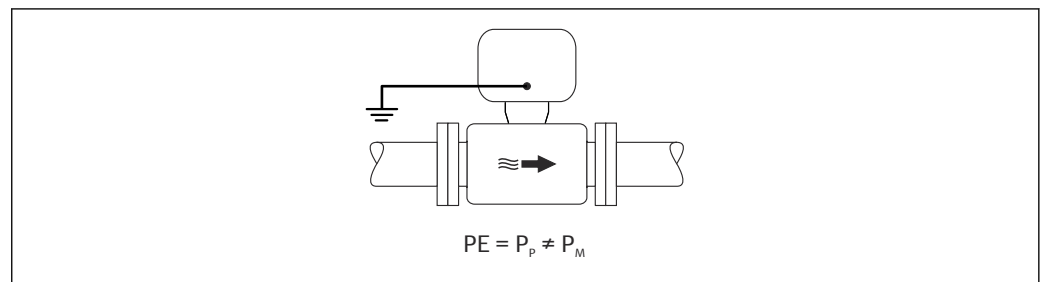

A0044855

1. Use the "Measurement isolated from ground" option, while observing the operating conditions for measurement isolated from ground.
2. Connect the connection housing of the transmitter or sensor to ground potential by means of the ground terminal provided for this purpose.

Metal, ungrounded pipe with insulating liner

The sensor and transmitter are installed in a way that provides electrical insulation from PE. The medium and pipe have different potentials. The "Measurement isolated from ground" option minimizes harmful equalizing currents between P_M and P_p via the reference electrode.

Starting conditions:

- Metal pipe with insulating liner
- Equalizing currents through the medium cannot be ruled out.

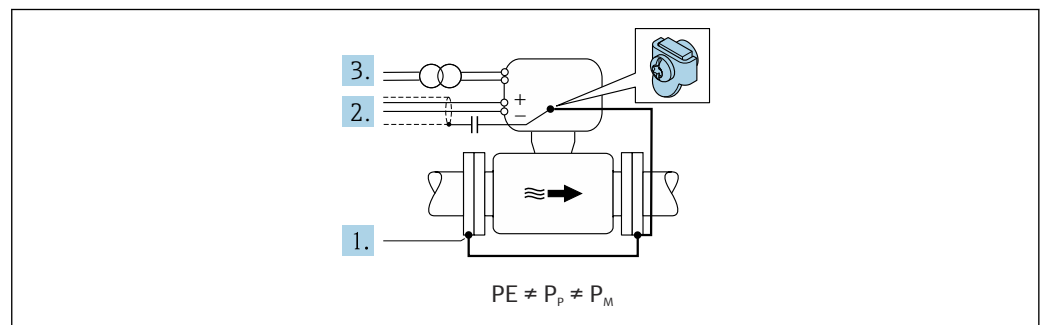

A0044857

1. Connect the pipe flanges and transmitter via the ground cable.
2. Route the shielding of the signal cables via a capacitor (recommended value $1.5\mu\text{F}/50\text{V}$).
3. Device connected to power supply such that it is floating in relation to the protective earth (isolation transformer). This measure is not required in the case of 24V DC supply voltage without PE (= SELV power unit).
4. Use the "Measurement isolated from ground" option, while observing the operating conditions for measurement isolated from ground.

7.4 Special connection instructions

7.4.1 Connection examples

PROFIBUS DP

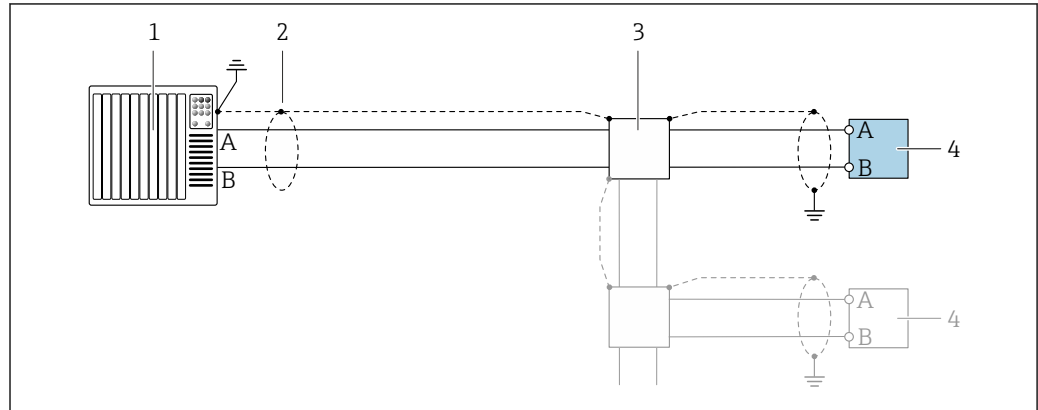

A0028765

14 Connection example for PROFIBUS DP, non-hazardous area and Zone 2/Div. 2

- 1 Control system (e.g. PLC)
- 2 Cable shield provided at one end. The cable shield must be grounded at both ends to comply with EMC requirements; observe cable specifications
- 3 Distribution box
- 4 Transmitter

i If baud rates > 1.5 MBaud an EMC cable entry must be used and the cable shield must continue as far as the terminal wherever possible.

7.5 Hardware settings

7.5.1 Setting the device address

PROFIBUS DP

The address must always be configured for a PROFIBUS DP/PA device. The valid address range is between 1 and 126. In a PROFIBUS DP/PA network, each address can only be assigned once. If an address is not configured correctly, the device is not recognized by the master. All measuring devices are delivered from the factory with the device address 126 and with the software addressing method.

Setting the address

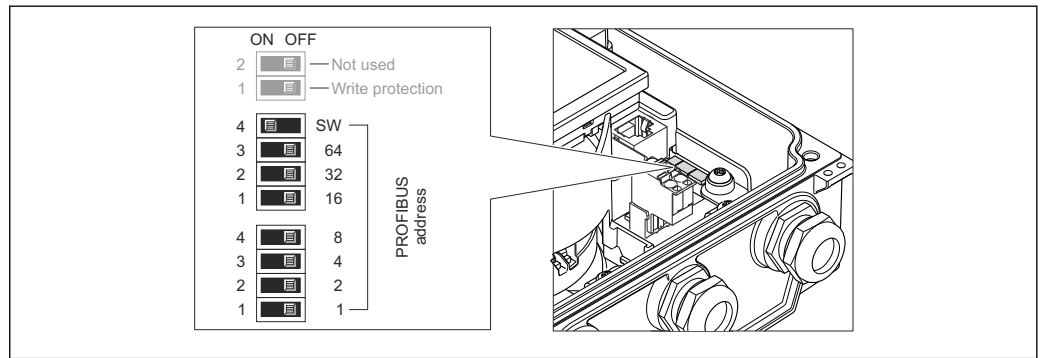

15 Addressing using DIP switches on the I/O electronics module

1. Loosen the 4 fixing screws on the housing cover.
2. Disable software addressing (OFF) via the top DIP switch 4 (SW).
3. Set the desired device address via the corresponding DIP switches.
 - ↳ Example → 15, 57: $1 + 16 + 32 = \text{device address } 49$
The device demands rebooting after 10 s. After rebooting, hardware addressing is enabled with the configured IP address.
4. Reverse the removal procedure to reassemble the transmitter.

7.5.2 Enabling the terminating resistor

PROFIBUS DP

To avoid incorrect communication transmission caused by impedance mismatch, terminate the PROFIBUS DP cable correctly at the start and end of the bus segment.

- If the device is operated with a baud rate of 1.5 MBaud and under:
For the last transmitter on the bus, terminate via DIP switch 2 (bus termination) and DIP switch 1 and 3 (bus polarization). Setting: ON - ON - ON → 16, 57.
- For baud rates > 1.5 MBaud:
Due to the capacitance load of the user and the line reflections generated as a result, ensure that an external bus terminator is used.

i It is generally advisable to use an external bus terminator as the entire segment can fail if a device that is terminated internally is defective.

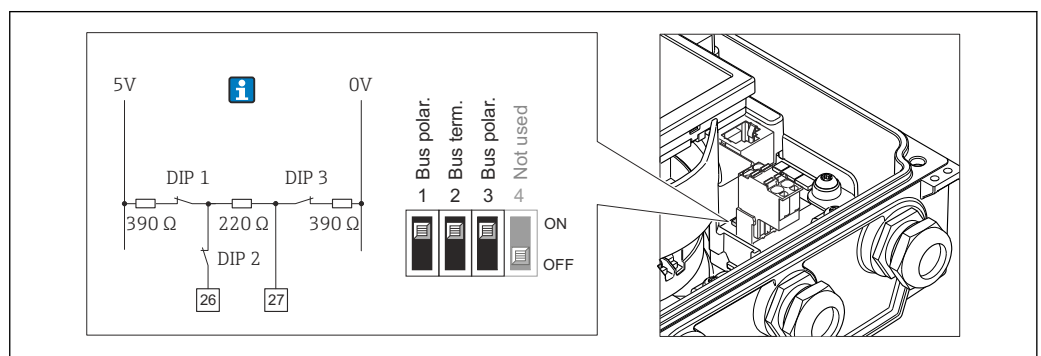

16 Termination using DIP switches on the I/O electronics module (for baud rates < 1.5 MBaud)

7.6 Ensuring the degree of protection

7.6.1 Degree of protection IP66/67, Type 4X enclosure

The measuring device fulfills all the requirements for the IP66/67 degree of protection, Type 4X enclosure.

To guarantee IP66/67 degree of protection, Type 4X enclosure, carry out the following steps after the electrical connection:

1. Check that the housing seals are clean and fitted correctly. Dry, clean or replace the seals if necessary.
2. Tighten all housing screws and screw covers.
3. Firmly tighten the cable glands.
4. To ensure that moisture does not enter the cable entry, route the cable so that it loops down before the cable entry ("water trap").

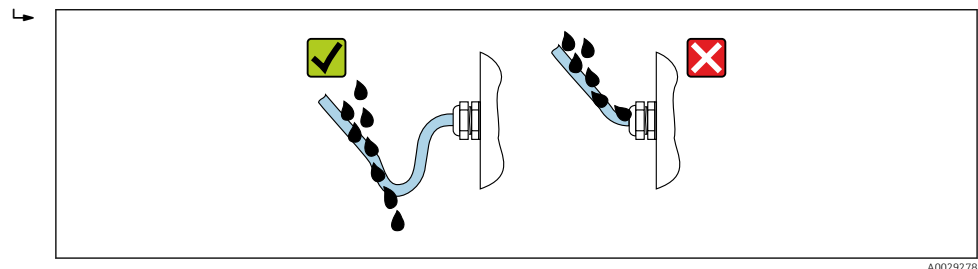

5. Insert dummy plugs (corresponding to the housing degree of protection) into unused cable entries.

NOTICE

Standard dummy plugs used for transportation do not have the appropriate degree of protection and can result in damage to the device!

- ▶ Use suitable dummy plugs corresponding to the degree of protection.

7.6.2 Degree of protection IP68, Type 6P enclosure, with "Cust-potted" option





Depending on the version, the sensor meets all the requirements of IP68 degree of protection, Type 6P enclosure → 185 and can be used as a remote version → 27.

The degree of protection of the transmitter is always only IP66/67, Type 4X enclosure and the transmitter must therefore be treated accordingly → 58.

To guarantee IP68 degree of protection, Type 6P enclosure for the "Cust-potted" options, carry out the following steps after the electrical connection:

1. Firmly tighten the cable glands (torque: 2 to 3.5 Nm) until there is no gap between the bottom of the cover and the housing support surface.
2. Firmly tighten the union nut of the cable glands.
3. Pot the field housing with a potting compound.
4. Check that the housing seals are clean and fitted correctly. Dry, clean or replace the seals if necessary.
5. Tighten all housing screws and screw covers (torque: 20 to 30 Nm).

7.7 Post-connection check

Are cables or the device undamaged (visual inspection)?	<input type="checkbox"/>
Do the cables used meet the requirements →  41?	<input type="checkbox"/>
Do the cables have adequate strain relief?	<input type="checkbox"/>
Are all the cable glands installed, firmly tightened and leak-tight? Cable run with "water trap" →  58?	<input type="checkbox"/>
Only for remote version: is the sensor connected to the right transmitter? Check the serial number on the nameplate of the sensor and transmitter.	<input type="checkbox"/>
Does the supply voltage match the specifications on the transmitter nameplate →  181?	<input type="checkbox"/>
Is the terminal assignment correct →  43?	<input type="checkbox"/>
If supply voltage is present, do values appear on the display module?	<input type="checkbox"/>
Is the potential equalization established correctly ?	<input type="checkbox"/>
Are all housing covers installed and the screws tightened with the correct tightening torque?	<input type="checkbox"/>

8 Operation methods

8.1 Overview of operation methods

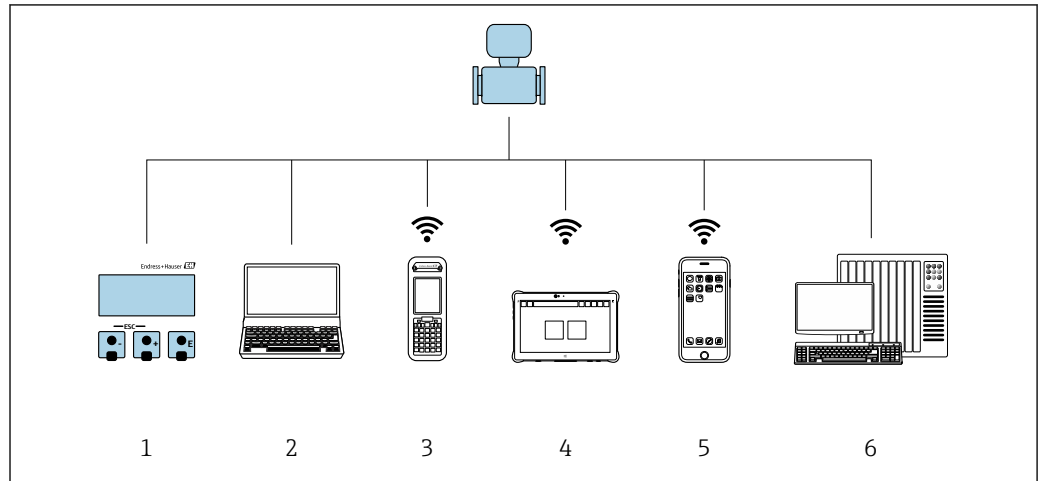



A0046501

- 1 Local operation via display module
- 2 Computer with Web browser (e.g. Internet Explorer) or with operating tool (e.g. FieldCare, DeviceCare, AMS Device Manager, SIMATIC PDM)
- 3 Field Xpert SFX350 or SFX370
- 4 Field Xpert SMT70
- 5 Mobile handheld terminal
- 6 Control system (e.g. PLC)

i For custody transfer, once the device has been put into circulation or sealed, its operation is restricted.

8.2 Structure and function of the operating menu

8.2.1 Structure of the operating menu

 For an overview of the operating menu for experts, see the "Description of Device Parameters" document supplied with the device →  205



 17 Schematic structure of the operating menu

A0018237-EN

8.2.2 Operating philosophy

The individual parts of the operating menu are assigned to certain user roles (operator, maintenance etc.). Each user role contains typical tasks within the device lifecycle.

 For custody transfer, once the device has been put into circulation or sealed, its operation is restricted.

Menu/parameter		User role and tasks	Content/meaning
Language	task-oriented	Role "Operator", "Maintenance" Tasks during operation: <ul style="list-style-type: none"> ▪ Configuration of the operational display ▪ Reading measured values 	<ul style="list-style-type: none"> ▪ Defining the operating language ▪ Defining the Web server operating language ▪ Resetting and controlling totalizers
Operation			<ul style="list-style-type: none"> ▪ Configuring the operational display (e.g. display format, display contrast) ▪ Resetting and controlling totalizers
Setup		"Maintenance" role Commissioning: Configuration of the measurement	Wizards for fast commissioning: <ul style="list-style-type: none"> ▪ Setting the system units ▪ Setting the input ▪ Configuring the outputs ▪ Configuration of the operational display ▪ Defining the output conditioning ▪ Setting the low flow cut off ▪ Configuring empty pipe detection Advanced setup <ul style="list-style-type: none"> ▪ For more customized configuration of the measurement (adaptation to special measuring conditions) ▪ Configuration of totalizers ▪ Configuration of electrode cleaning (optional) ▪ Configuring the WLAN settings ▪ Administration (define access code, reset measuring device)
Diagnostics		"Maintenance" role Fault elimination: <ul style="list-style-type: none"> ▪ Diagnostics and elimination of process and device errors ▪ Measured value simulation 	Contains all parameters for error detection and analyzing process and device errors: <ul style="list-style-type: none"> ▪ Diagnostic list Contains up to 5 currently pending diagnostic messages. ▪ Event logbook Contains event messages that have occurred. ▪ Device information Contains information for identifying the device. ▪ Measured values Contains all current measured values. ▪ Analog inputs Is used to display the analog input. ▪ Data logging submenu with "Extended HistoROM" order option Storage and visualization of measured values ▪ Heartbeat The functionality of the device is checked on demand and the verification results are documented. ▪ Simulation Is used to simulate measured values or output values.

Menu/parameter		User role and tasks	Content/meaning
Expert	function-oriented	<p>Tasks that require detailed knowledge of the function of the device:</p> <ul style="list-style-type: none"> ▪ Commissioning measurements under difficult conditions ▪ Optimal adaptation of the measurement to difficult conditions ▪ Detailed configuration of the communication interface ▪ Error diagnostics in difficult cases 	<p>Contains all the parameters of the device and makes it possible to access these parameters directly using an access code. The structure of this menu is based on the function blocks of the device:</p> <ul style="list-style-type: none"> ▪ System Contains all higher-order device parameters which do not concern the measurement or the communication interface. ▪ Sensor Configuration of the measurement. ▪ Input Configuring the status input. ▪ Output Configuration of the analog current outputs as well as the pulse/frequency and switch output. ▪ Communication Configuration of the digital communication interface and the Web server. ▪ Submenus for function blocks (e.g. "Analog Inputs") Configuration of function blocks. ▪ Application Configuration of the functions that go beyond the actual measurement (e.g. totalizer). ▪ Diagnostics Error detection and analysis of process and device errors and for device simulation and Heartbeat Technology.

8.3 Access to the operating menu via the local display

8.3.1 Operational display

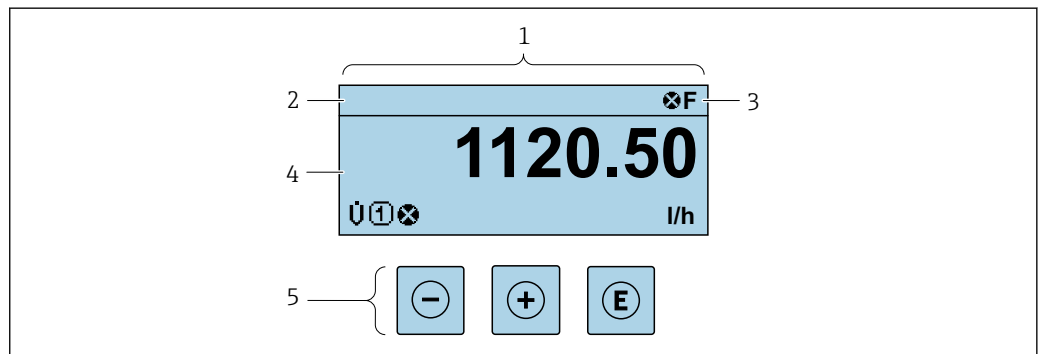

- 1 Operational display
- 2 Device tag → 97
- 3 Status area
- 4 Display area for measured values (4-line)
- 5 Operating elements → 68

Status area

The following symbols appear in the status area of the operational display at the top right:

- Status signals → 129
 - **F**: Failure
 - **C**: Function check
 - **S**: Out of specification
 - **M**: Maintenance required
- Diagnostic behavior → 130
 - : Alarm
 - : Warning
 - : Locking (the device is locked via the hardware)
 - : Communication (communication via remote operation is active)

Display area

In the display area, each measured value is prefaced by certain symbol types for further description:

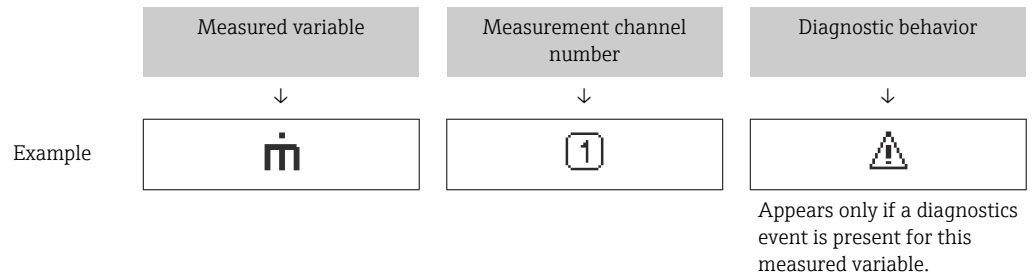

Measured variables

Symbol	Meaning
	Volume flow
	Conductivity
	Mass flow
	Totalizer The measurement channel number indicates which of the three totalizers is displayed.
	Status input

Measurement channel numbers

Symbol	Meaning
	Measurement channel 1 to 4
The measurement channel number is displayed only if more than one channel is present for the same measured variable type (e.g. Totalizer 1 to 3).	

Diagnostic behavior

The diagnostic behavior pertains to a diagnostic event that is relevant to the displayed measured variable. For information on the symbols → 130

The number and display format of the measured values can be configured via the **Format display** parameter (→ 100).

8.3.2 Navigation view

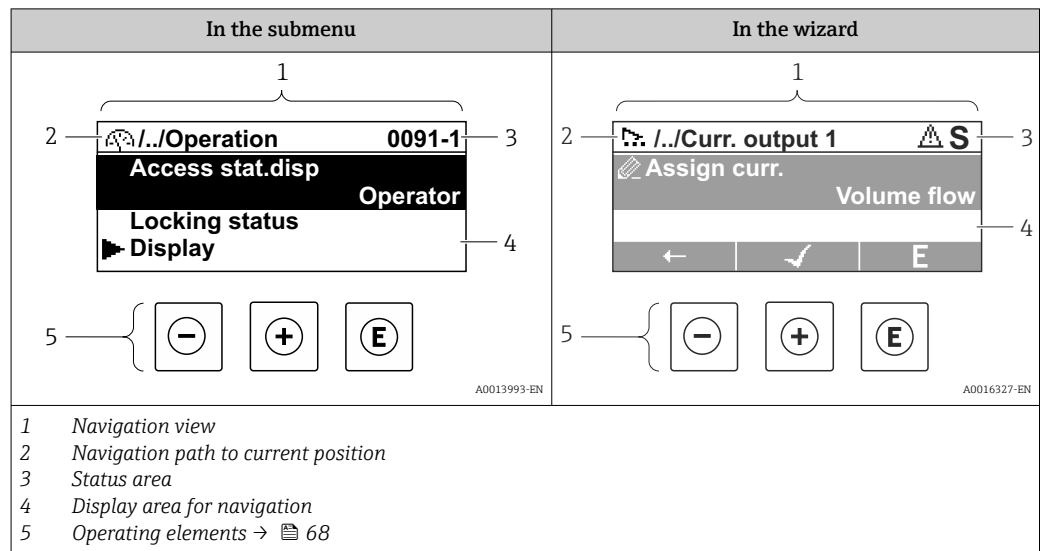

Navigation path

The navigation path - displayed at the top left in the navigation view - consists of the following elements:

	<ul style="list-style-type: none"> In the submenu: Display symbol for menu In the wizard: Display symbol for wizard 	Omission symbol for operating menu levels in between	Name of current <ul style="list-style-type: none"> Submenu Wizard Parameters
	↓	↓	↓
Examples		/ .. /	Display
		/ .. /	Display

For more information about the icons in the menu, refer to the "Display area" section → 66

Status area





The following appears in the status area of the navigation view in the top right corner:

- In the submenu
 - The direct access code for the parameter you are navigating to (e.g. 0022-1)
 - If a diagnostic event is present, the diagnostic behavior and status signal
- In the wizard
 - If a diagnostic event is present, the diagnostic behavior and status signal





- For information on the diagnostic behavior and status signal → 129
- For information on the function and entry of the direct access code → 71

Display area

Menus

Symbol	Meaning
	Operation Appears: <ul style="list-style-type: none"> In the menu next to the "Operation" selection At the left in the navigation path in the Operation menu
	Setup Appears: <ul style="list-style-type: none"> In the menu next to the "Setup" selection At the left in the navigation path in the Setup menu
	Diagnostics Appears: <ul style="list-style-type: none"> In the menu next to the "Diagnostics" selection At the left in the navigation path in the Diagnostics menu
	Expert Appears: <ul style="list-style-type: none"> In the menu next to the "Expert" selection At the left in the navigation path in the Expert menu



Submenus, wizards, parameters

Symbol	Meaning
	Submenu
	Wizard
	Parameters within a wizard  No display symbol exists for parameters in submenus.

Locking

Symbol	Meaning
	Parameter locked When displayed in front of a parameter name, indicates that the parameter is locked. <ul style="list-style-type: none"> By a user-specific access code By the hardware write protection switch

Wizard operation

Symbol	Meaning
	Switches to the previous parameter.
	Confirms the parameter value and switches to the next parameter.
	Opens the editing view of the parameter.

8.3.3 Editing view

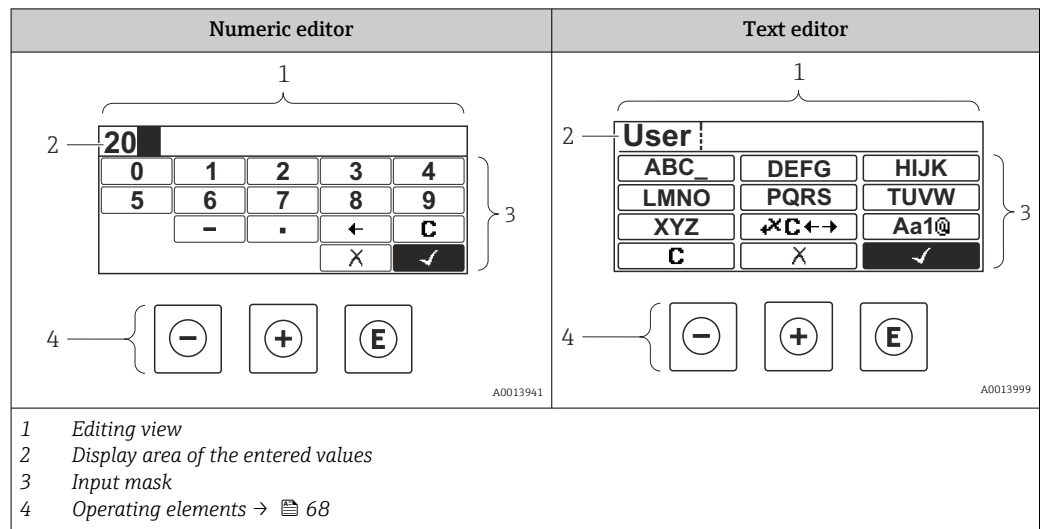

Input mask









The following input symbols are available in the input mask of the numeric and text editor:

Numeric editor





Symbol	Meaning
0 ... 9	Selection of numbers from 0 to 9.
.	Inserts decimal separator at the input position.
-	Inserts minus sign at the input position.
✓	Confirms selection.
←	Moves the input position one position to the left.
X	Exits the input without applying the changes.
C	Clears all entered characters.

Text editor



Symbol	Meaning
Aa1@ ... XYZ	Toggle <ul style="list-style-type: none"> Between upper-case and lower-case letters For entering numbers For entering special characters
ABC_ ... XYZ	Selection of letters from A to Z.

 	Selection of letters from a to z.
 	Selection of special characters.
	Confirms selection.
	Switches to the selection of the correction tools.
	Exits the input without applying the changes.
	Clears all entered characters.

Correction symbols under 

Symbol	Meaning
	Clears all entered characters.
	Moves the input position one position to the right.
	Moves the input position one position to the left.
	Deletes one character immediately to the left of the input position.

8.3.4 Operating elements

Key	Meaning
	<p>Minus key</p> <p><i>In menu, submenu</i> Moves the selection bar upwards in a picklist.</p> <p><i>With a wizard</i> Confirms the parameter value and goes to the previous parameter.</p> <p><i>For text and numeric editor</i> In the input mask, moves the selection bar to the left (backwards).</p>
	<p>Plus key</p> <p><i>In menu, submenu</i> Moves the selection bar downwards in a picklist.</p> <p><i>With a wizard</i> Confirms the parameter value and goes to the next parameter.</p> <p><i>For text and numeric editor</i> In the input mask, moves the selection bar to the right (forwards).</p>

Key	Meaning
Ⓔ	<p>Enter key</p> <p><i>For operational display</i> Pressing the key for 2 s opens the context menu including the selection for activating the keypad lock.</p> <p><i>In menu, submenu</i></p> <ul style="list-style-type: none"> ▪ Pressing the key briefly: <ul style="list-style-type: none"> ▪ Opens the selected menu, submenu or parameter. ▪ Starts the wizard. ▪ If help text is open, closes the help text of the parameter. ▪ Pressing the key for 2 s in a parameter: If present, opens the help text for the function of the parameter. <p><i>With a wizard</i> Opens the editing view of the parameter.</p> <p><i>For text and numeric editor</i></p> <ul style="list-style-type: none"> ▪ Pressing the key briefly: <ul style="list-style-type: none"> ▪ Opens the selected group. ▪ Carries out the selected action. ▪ Pressing the key for 2 s confirms the edited parameter value.
⊖ + ⊕	<p>Escape key combination (press keys simultaneously)</p> <p><i>In menu, submenu</i></p> <ul style="list-style-type: none"> ▪ Pressing the key briefly: <ul style="list-style-type: none"> ▪ Exits the current menu level and takes you to the next level up. ▪ If help text is open, closes the help text of the parameter. ▪ Pressing the key for 2 s returns you to the operational display ("home position"). <p><i>With a wizard</i> Exits the wizard and takes you to the next level up.</p> <p><i>For text and numeric editor</i> Closes the text or numeric editor without applying changes.</p>
⊖ + ⊕ + Ⓔ	<p>Minus/Plus/Enter key combination (press and hold down the keys simultaneously)</p> <p><i>For operational display</i> Enables or disables the keypad lock (only SD02 display module).</p>

8.3.5 Opening the context menu

Using the context menu, the user can call up the following menus quickly and directly from the operational display:

- Setup
- Simulation

Calling up and closing the context menu

The user is in the operational display.

1. Press the ⊖ and Ⓔ keys for longer than 3 seconds.
 - ↳ The context menu opens.

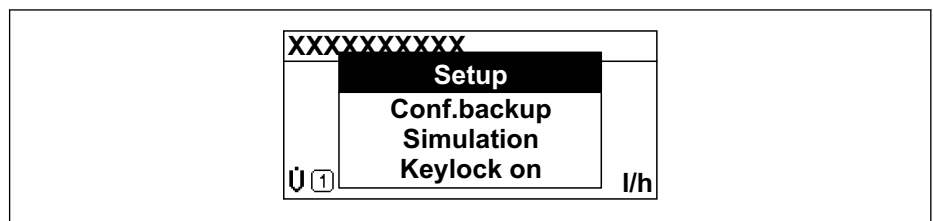

2. Press ⊖ + ⊕ simultaneously.
 - ↳ The context menu is closed and the operational display appears.

Calling up the menu via the context menu

1. Open the context menu.

2. Press \boxplus to navigate to the desired menu.
3. Press \boxminus to confirm the selection.
 - ↳ The selected menu opens.

8.3.6 Navigating and selecting from list

Different operating elements are used to navigate through the operating menu. The navigation path is displayed on the left in the header. Icons are displayed in front of the individual menus. These icons are also shown in the header during navigation.

i For an explanation of the navigation view with symbols and operating elements → 65

Example: Setting the number of displayed measured values to "2 values"

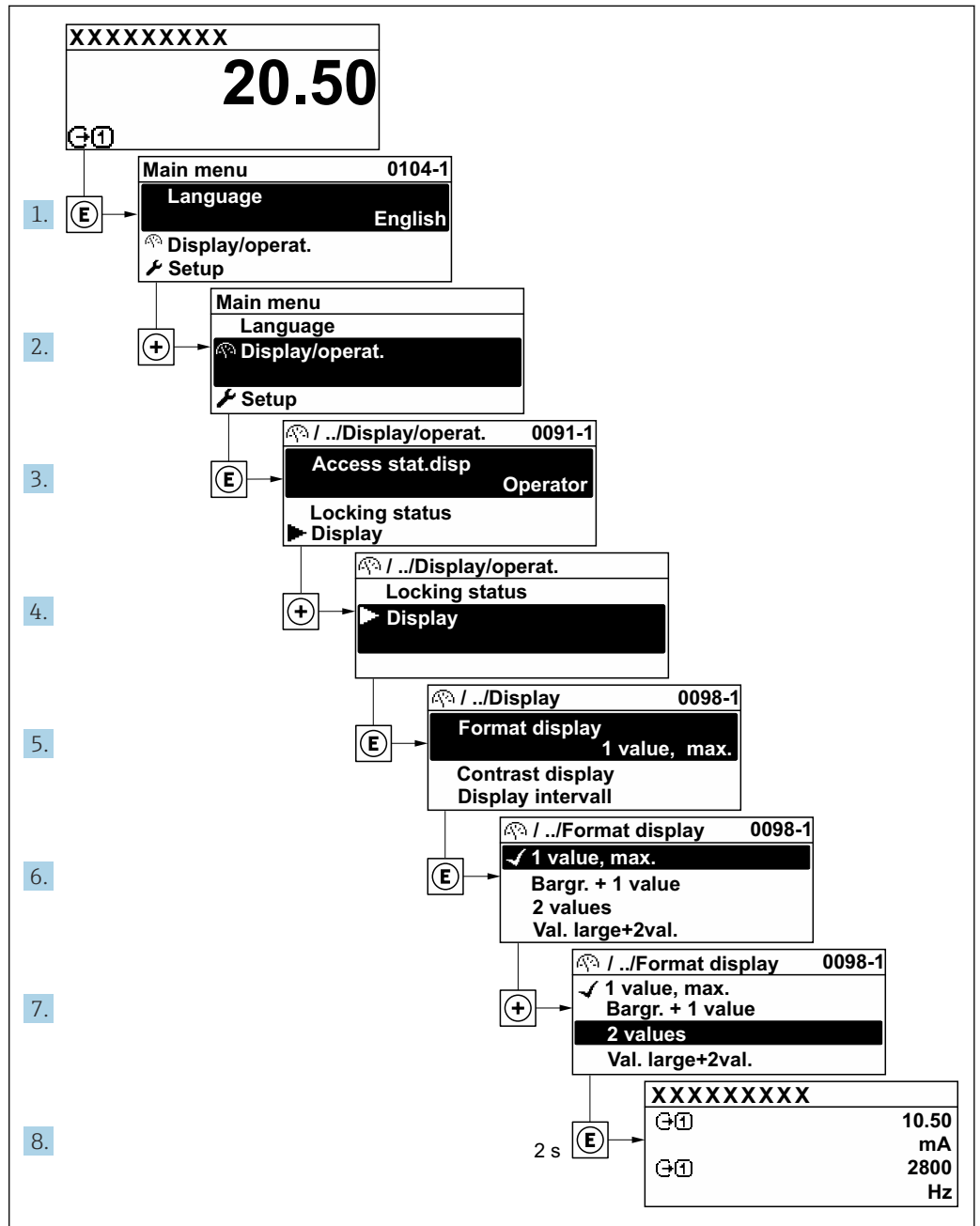

A0029562-EN

8.3.7 Calling the parameter directly

A parameter number is assigned to every parameter to be able to access a parameter directly via the onsite display. Entering this access code in the **Direct access** parameter calls up the desired parameter directly.

Navigation path

Expert → Direct access

The direct access code consists of a 5-digit number (at maximum) and the channel number, which identifies the channel of a process variable: e.g. 00914-2. In the navigation view, this appears on the right-hand side in the header of the selected parameter.

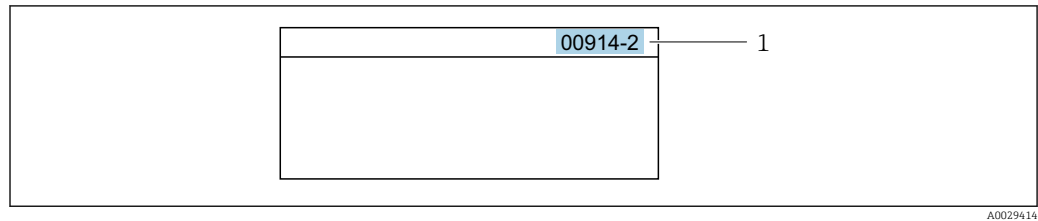

1 Direct access code

Note the following when entering the direct access code:

- The leading zeros in the direct access code do not have to be entered.
Example: Enter "914" instead of "00914"
- If no channel number is entered, channel 1 is opened automatically.
Example: Enter 00914 → **Assign process variable** parameter
- If a different channel is opened: Enter the direct access code with the corresponding channel number.
Example: Enter 00914-2 → **Assign process variable** parameter



For the direct access codes of the individual parameters, see the "Description of Device Parameters" document for the device

8.3.8 Calling up help text

Help text is available for some parameters and can be called up from the navigation view. The help text provides a brief explanation of the parameter function and thereby supports swift and safe commissioning.

Calling up and closing the help text

The user is in the navigation view and the selection bar is on a parameter.

1. Press for 2 s.
↳ The help text for the selected parameter opens.

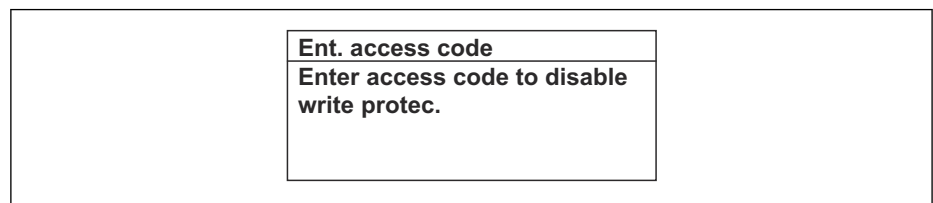

18 Example: Help text for parameter "Enter access code"

2. Press + simultaneously.
↳ The help text is closed.

8.3.9 Changing the parameters

i For a description of the editing view - consisting of the text editor and numeric editor - with symbols → 67, for a description of the operating elements → 68

Example: Changing the tag name in the "Tag description" parameter from 001-FT-101 to 001-FT-102

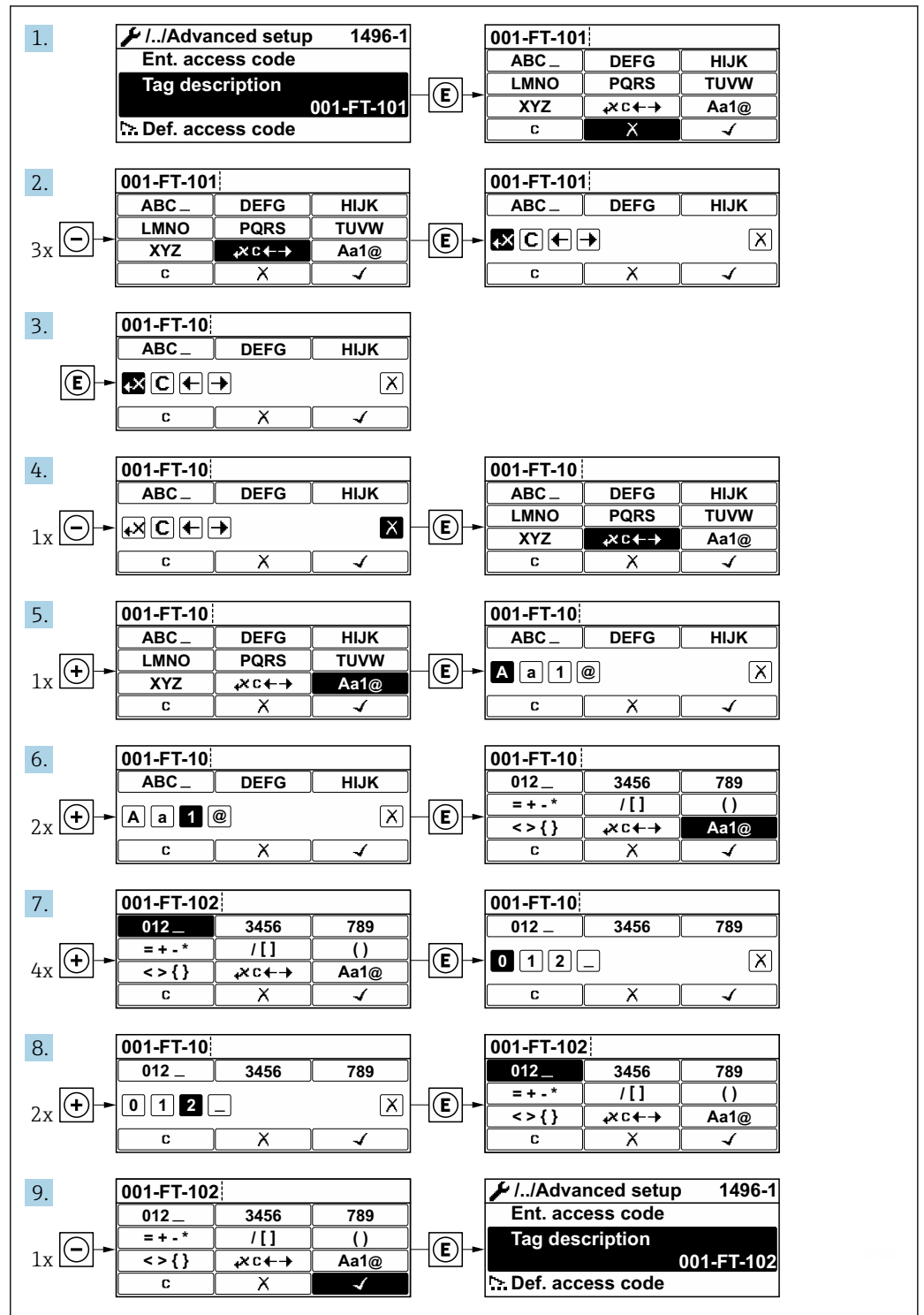

A message is displayed if the value entered is outside the permitted value range.

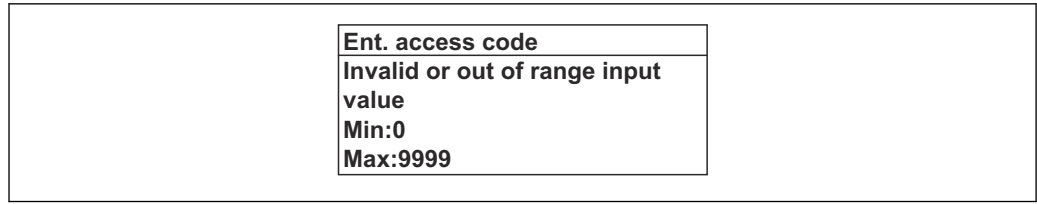

A0014049-EN

8.3.10 User roles and related access authorization

The two user roles "Operator" and "Maintenance" have different write access to the parameters if the customer defines a user-specific access code. This protects the device configuration via the local display from unauthorized access → 116.

Defining access authorization for user roles

An access code is not yet defined when the device is delivered from the factory. Access authorization (read and write access) to the device is not restricted and corresponds to the "Maintenance" user role.

- ▶ Define the access code.
 - ↳ The "Operator" user role is redefined in addition to the "Maintenance" user role. Access authorization differs for the two user roles.

Access authorization to parameters: "Maintenance" user role

Access code status	Read access	Write access
An access code has not yet been defined (factory setting).	✓	✓
After an access code has been defined.	✓	✓ ¹⁾

1) The user only has write access after entering the access code.

Access authorization to parameters: "Operator" user role

Access code status	Read access	Write access
After an access code has been defined.	✓	-- ¹⁾

1) Despite the defined access code, certain parameters can always be modified and thus are exempted from the write protection, as they do not affect the measurement. Refer to the "Write protection via access code" section

The user role with which the user is currently logged on is indicated by the **Access status display** parameter. Navigation path: Operation → Access status display

8.3.11 Disabling write protection via access code

If the -symbol appears on the local display in front of a parameter, the parameter is write-protected by a user-specific access code and its value cannot be changed at the moment using local operation → 116.

Parameter write protection via local operation can be disabled by entering the user-specific access code in the **Enter access code** parameter (→ 106) via the respective access option.

1. After you press , the input prompt for the access code appears.
2. Enter the access code.
 - ↳ The -symbol in front of the parameters disappears; all previously write-protected parameters are now re-enabled.

8.3.12 Enabling and disabling the keypad lock



The keypad lock makes it possible to block access to the entire operating menu via local operation. As a result, it is no longer possible to navigate through the operating menu or change the values of individual parameters. Users can only read the measured values on the operational display.

The keypad lock is switched on and off via the context menu.

Switching on the keypad lock



-  The keypad lock is switched on automatically:
- If the device has not been operated via the display for > 1 minute.
 - Each time the device is restarted.

To activate the keylock manually:

1. The device is in the measured value display.
Press the  and  keys for 3 seconds.
↳ A context menu appears.
2. In the context menu select the **Keylock on** option.
↳ The keypad lock is switched on.

-  If the user attempts to access the operating menu while the keypad lock is active, the **Keylock on** message appears.



Switching off the keypad lock

- ▶ The keypad lock is switched on.
Press the  and  keys for 3 seconds.
↳ The keypad lock is switched off.

8.4 Access to the operating menu via the Web browser

8.4.1 Function scope

Thanks to the integrated Web server, the device can be operated and configured via a Web browser and via a service interface (CDI-RJ45). The structure of the operating menu is the same as for the local display. In addition to the measured values, device status information is also displayed, allowing users to monitor the status of the device. Furthermore the device data can be managed and the network parameters can be configured.



-  For additional information on the Web server, refer to the Special Documentation for the device →  205

8.4.2 Prerequisites



Computer hardware

Hardware	Interface	
	CDI-RJ45	WLAN
Interface	The computer must have an RJ45 interface.	The operating unit must have a WLAN interface.
Connection	Standard Ethernet cable with RJ45 connector.	Connection via Wireless LAN.
Screen	Recommended size: ≥12" (depends on the screen resolution)	

Computer software



Software	Interface	
	CDI-RJ45	WLAN
Recommended operating systems	<ul style="list-style-type: none"> ▪ Microsoft Windows 8 or higher. ▪ Mobile operating systems: <ul style="list-style-type: none"> ▪ iOS ▪ Android <p> Microsoft Windows XP is supported.</p> <p> Microsoft Windows 7 is supported.</p>	
Web browsers supported	<ul style="list-style-type: none"> ▪ Microsoft Internet Explorer 8 or higher ▪ Microsoft Edge ▪ Mozilla Firefox ▪ Google Chrome ▪ Safari 	

Computer settings



Settings	Interface	
	CDI-RJ45	WLAN
User rights	Appropriate user rights (e.g. administrator rights) for TCP/IP and proxy server settings are necessary (for adjusting the IP address, subnet mask etc.).	
Proxy server settings of the Web browser	The Web browser setting <i>Use a Proxy Server for Your LAN</i> must be deselected .	
JavaScript	<p>JavaScript must be enabled.</p> <p> If JavaScript cannot be enabled: enter <code>http://192.168.1.212/basic.html</code> in the address line of the Web browser. A fully functional but simplified version of the operating menu structure starts in the Web browser.</p> <p> When installing a new firmware version: To enable correct data display, clear the temporary memory (cache) of the Web browser under Internet options.</p>	
Network connections	Only the active network connections to the measuring device should be used.	
	Switch off all other network connections such as WLAN.	Switch off all other network connections.

 In the event of connection problems: →  127

Measuring device: Via CDI-RJ45 service interface

Device	CDI-RJ45 service interface
Measuring device	The measuring device has an RJ45 interface.
Web server	<p>Web server must be enabled; factory setting: ON</p> <p> For information on enabling the Web server →  80</p>

Measuring device: via WLAN interface

Device	WLAN interface
Measuring device	The measuring device has a WLAN antenna: Transmitter with integrated WLAN antenna
Web server	<p>Web server and WLAN must be enabled; factory setting: ON</p> <p> For information on enabling the Web server →  80</p>

8.4.3 Establishing a connection

Via service interface (CDI-RJ45)

Preparing the measuring device

Configuring the Internet protocol of the computer

The following information refers to the default Ethernet settings of the device.

IP address of the device: 192.168.1.212 (factory setting)

1. Switch on the measuring device.
2. Connect to the computer using a cable .
3. If a 2nd network card is not used, close all the applications on the notebook.
 - ↳ Applications requiring Internet or a network, such as e-mail, SAP applications, Internet or Windows Explorer.
4. Close any open Internet browsers.
5. Configure the properties of the Internet protocol (TCP/IP) as defined in the table:

IP address	192.168.1.XXX; for XXX all numerical sequences except: 0, 212 and 255 → e.g. 192.168.1.213
Subnet mask	255.255.255.0
Default gateway	192.168.1.212 or leave cells empty

Via WLAN interface

Configuring the Internet protocol of the mobile terminal

NOTICE

If the WLAN connection is lost during the configuration, settings made may be lost.

- ▶ Make sure that the WLAN connection is not disconnected while configuring the device.

NOTICE

In principle, avoid simultaneous access to the measuring device via the service interface (CDI-RJ45) and the WLAN interface from the same mobile terminal. This could cause a network conflict.

- ▶ Only activate one service interface (CDI-RJ45 service interface or WLAN interface).
- ▶ If simultaneous communication is necessary: configure different IP address ranges, e.g. 192.168.0.1 (WLAN interface) and 192.168.1.212 (CDI-RJ45 service interface).

Preparing the mobile terminal

- ▶ Enable WLAN reception on the mobile terminal.

Establishing a connection from the mobile terminal to the measuring device

1. In the WLAN settings of the mobile terminal:
Select the measuring device using the SSID (e.g. EH_Promag__A802000).
2. If necessary, select the WPA2 encryption method.

3. Enter the password: serial number of the measuring device ex-works (e.g. L100A802000).
 - ↳ LED on display module flashes: it is now possible to operate the measuring device with the Web browser, FieldCare or DeviceCare.

i The serial number can be found on the nameplate.

i To ensure the safe and swift assignment of the WLAN network to the measuring point, it is advisable to change the SSID name. It should be possible to clearly assign the SSID name to the measuring point (e.g. tag name) as it is displayed as the WLAN network.

Disconnecting

- ▶ After configuring the device:
Terminate the WLAN connection between the operating unit and measuring device.

Starting the Web browser

1. Start the Web browser on the computer.
2. Enter the IP address of the Web server in the address line of the Web browser: 192.168.1.212
 - ↳ The login page appears.

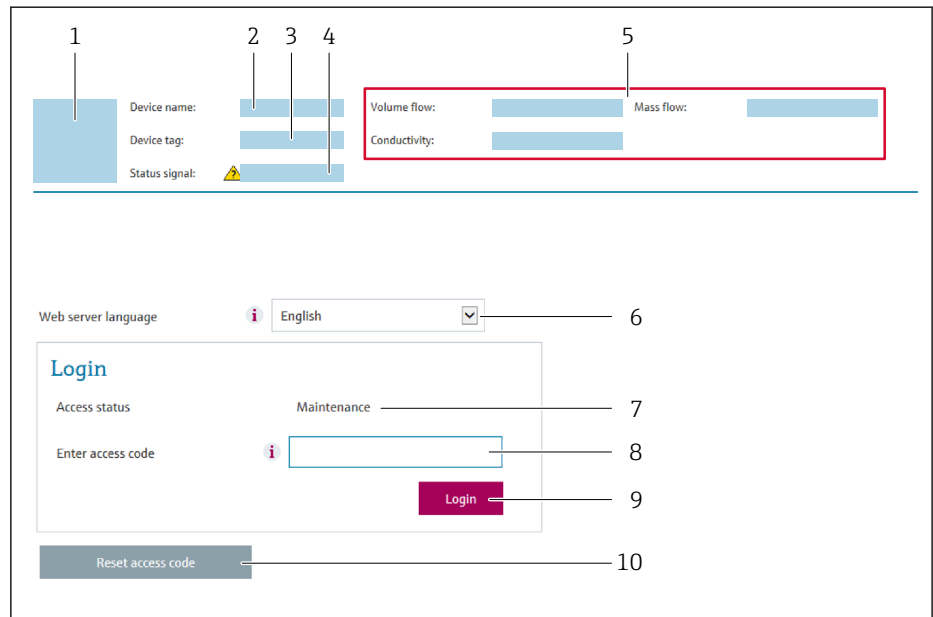

- 1 Picture of device
- 2 Device name
- 3 Device tag
- 4 Status signal
- 5 Current measured values
- 6 Operating language
- 7 User role
- 8 Access code
- 9 Login
- 10 Reset access code (→ 114)

i If a login page does not appear, or if the page is incomplete → 127

8.4.4 Logging on

1. Select the preferred operating language for the Web browser.

2. Enter the user-specific access code.
3. Press **OK** to confirm your entry.

Access code	0000 (factory setting); can be changed by customer
--------------------	--

 If no action is performed for 10 minutes, the Web browser automatically returns to the login page.

8.4.5 User interface

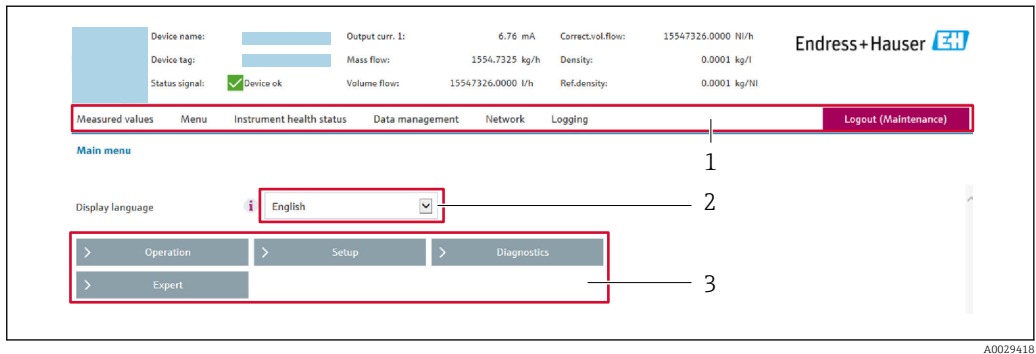

- 1 Function row
- 2 Local display language
- 3 Navigation area

Header

The following information appears in the header:

- Device name
- Device tag
- Device status with status signal →  132
- Current measured values

Function row

Functions	Meaning
Measured values	Displays the measured values of the device
Menu	<ul style="list-style-type: none"> ■ Access to the operating menu from the measuring device ■ The structure of the operating menu is the same as for the local display  For detailed information on the structure of the operating menu, see the Operating Instructions for the measuring device
Device status	Displays the diagnostic messages currently pending, listed in order of priority
Data management	Data exchange between PC and measuring device: <ul style="list-style-type: none"> ■ Device configuration: <ul style="list-style-type: none"> ■ Load settings from the device (XML format, save configuration) ■ Save settings to the device (XML format, restore configuration) ■ Logbook - Export Event logbook (.csv file) ■ Documents - Export documents: <ul style="list-style-type: none"> ■ Export backup data record (.csv file, create documentation of the measuring point configuration) ■ Verification report (PDF file, only available with the "Heartbeat Verification" application package) ■ File for system integration - If using fieldbuses, upload device drivers for system integration from the measuring device: PROFIBUS DP: GSD file

Functions	Meaning
Network configuration	Configuration and checking of all the parameters required for establishing the connection to the measuring device: <ul style="list-style-type: none"> ▪ Network settings (e.g. IP address, MAC address) ▪ Device information (e.g. serial number, firmware version)
Logout	End the operation and call up the login page

Navigation area

If a function is selected in the function bar, the submenus of the function open in the navigation area. The user can now navigate through the menu structure.

Working area

Depending on the selected function and the related submenus, various actions can be performed in this area:

- Configuring parameters
- Reading measured values
- Calling up help text
- Starting an upload/download

8.4.6 Disabling the Web server

The Web server of the measuring device can be switched on and off as required using the **Web server functionality** parameter.

Navigation

"Expert" menu → Communication → Web server

Parameter overview with brief description

Parameter	Description	Selection	Factory setting
Web server functionality	Switch the Web server on and off.	<ul style="list-style-type: none"> ▪ Off ▪ On 	On

Function scope of the "Web server functionality" parameter

Option	Description
Off	<ul style="list-style-type: none"> ▪ The web server is completely disabled. ▪ Port 80 is locked.
On	<ul style="list-style-type: none"> ▪ The complete functionality of the web server is available. ▪ JavaScript is used. ▪ The password is transferred in an encrypted state. ▪ Any change to the password is also transferred in an encrypted state.

Enabling the Web server

If the Web server is disabled it can only be re-enabled with the **Web server functionality** parameter via the following operating options:

- Via local display
- Via Bedientool "FieldCare"
- Via "DeviceCare" operating tool

8.4.7 Logging out

i Before logging out, perform a data backup via the **Data management** function (upload configuration from device) if necessary.

1. Select the **Logout** entry in the function row.
↳ The home page with the Login box appears.
2. Close the Web browser.
3. If no longer needed:
Reset modified properties of the Internet protocol (TCP/IP) →  77.

8.5 Access to the operating menu via the operating tool

The structure of the operating menu in the operating tools is identical to operation via the local display.

8.5.1 Connecting the operating tool

Via PROFIBUS DP network

This communication interface is available in device versions with PROFIBUS DP.

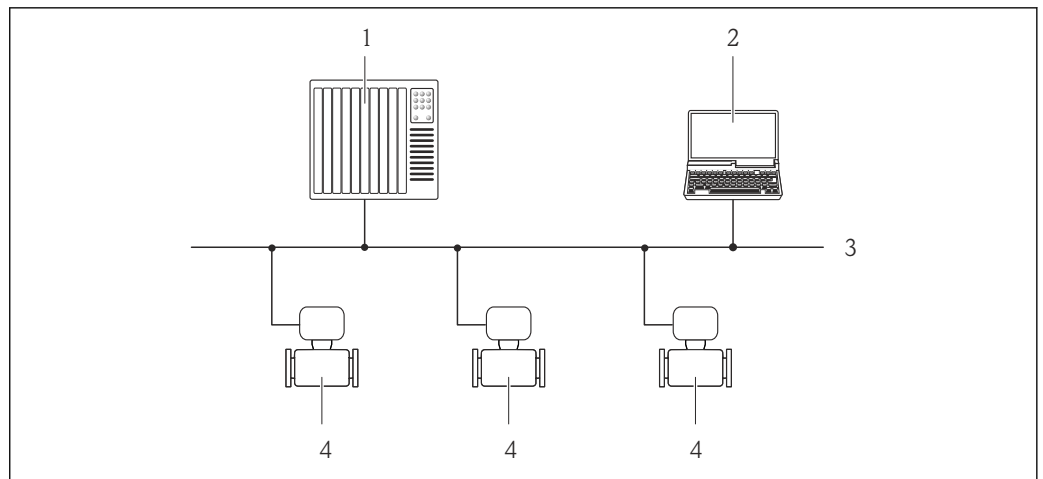

 19 Options for remote operation via PROFIBUS DP network

- 1 Automation system
- 2 Computer with PROFIBUS network card
- 3 PROFIBUS DP network
- 4 Measuring device

A0020903

Via service interface (CDI-RJ45)

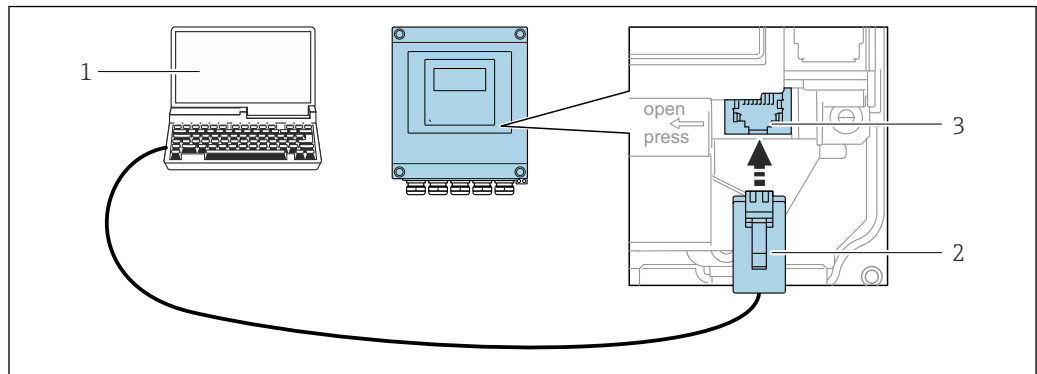

20 Connection via service interface (CDI-RJ45)

- 1 Computer with Web browser (e.g. Microsoft Internet Explorer, Microsoft Edge) for accessing the integrated device Web server or with "FieldCare", "DeviceCare" operating tool with COM DTM "CDI Communication TCP/IP"
- 2 Standard Ethernet connecting cable with RJ45 plug
- 3 Service interface (CDI-RJ45) of the measuring device with access to the integrated Web server

Via WLAN interface

The optional WLAN interface is available on the following device version:
 Order code for "Display", option BA "WLAN":
 4-line, illuminated, graphic display; touch control + WLAN

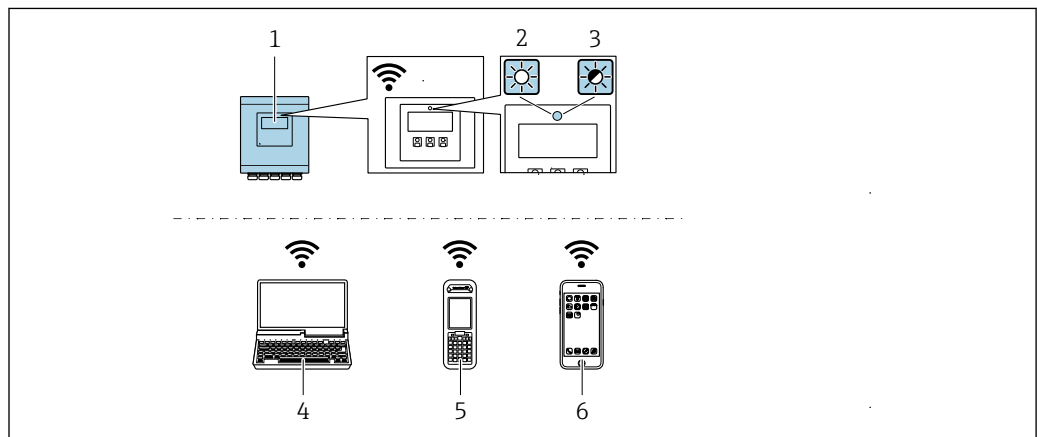

- 1 Transmitter with integrated WLAN antenna
- 2 LED lit constantly: WLAN reception is enabled on measuring device
- 3 LED flashing: WLAN connection established between operating unit and measuring device
- 4 Computer with WLAN interface and Web browser (e.g. Microsoft Internet Explorer, Microsoft Edge) for accessing the integrated device Web server or with operating tool (e.g. FieldCare, DeviceCare)
- 5 Mobile handheld terminal with WLAN interface and Web browser (e.g. Microsoft Internet Explorer, Microsoft Edge) for accessing the integrated device Web server or operating tool (e.g. FieldCare, DeviceCare)
- 6 Smart phone or tablet (e.g. Field Xpert SMT70)

Encryption	WPA2-PSK AES-128 (in accordance with IEEE 802.11i)
Configurable WLAN channels	1 to 11
Degree of protection	IP67
Available antenna	Internal antenna
Range	Typically 10 m (32 ft)

*Configuring the Internet protocol of the mobile terminal***NOTICE**

If the WLAN connection is lost during the configuration, settings made may be lost.

- ▶ Make sure that the WLAN connection is not disconnected while configuring the device.

NOTICE

In principle, avoid simultaneous access to the measuring device via the service interface (CDI-RJ45) and the WLAN interface from the same mobile terminal. This could cause a network conflict.

- ▶ Only activate one service interface (CDI-RJ45 service interface or WLAN interface).
- ▶ If simultaneous communication is necessary: configure different IP address ranges, e.g. 192.168.0.1 (WLAN interface) and 192.168.1.212 (CDI-RJ45 service interface).

Preparing the mobile terminal

- ▶ Enable WLAN reception on the mobile terminal.

Establishing a connection from the mobile terminal to the measuring device

1. In the WLAN settings of the mobile terminal:
Select the measuring device using the SSID (e.g. EH_Promag__A802000).
2. If necessary, select the WPA2 encryption method.
3. Enter the password: serial number of the measuring device ex-works (e.g. L100A802000).
↳ LED on display module flashes: it is now possible to operate the measuring device with the Web browser, FieldCare or DeviceCare.

 The serial number can be found on the nameplate.

 To ensure the safe and swift assignment of the WLAN network to the measuring point, it is advisable to change the SSID name. It should be possible to clearly assign the SSID name to the measuring point (e.g. tag name) as it is displayed as the WLAN network.

Disconnecting

- ▶ After configuring the device:
Terminate the WLAN connection between the operating unit and measuring device.

8.5.2 FieldCare

Function scope

FDT-based plant asset management tool from Endress+Hauser. It can configure all smart field devices in a system and helps you manage them. By using the status information, it is also a simple but effective way of checking their status and condition.

Access is via:

Typical functions:

- Parameterization of transmitters
- Loading and saving device data (upload/download)
- Documentation of the measuring point
- Visualization of the measured value memory (line recorder) and event logbook

 For additional information about FieldCare, see Operating Instructions BA00027S and BA00059S

Source for device description files

See information →  86

Establishing a connection

1. Start FieldCare and launch the project.
2. In the network: Add a device.
↳ The **Add device** window opens.
3. Select the **CDI Communication TCP/IP** option from the list and press **OK** to confirm.
4. Right-click **CDI Communication TCP/IP** and select the **Add device** option in the context menu that opens.
5. Select the desired device from the list and press **OK** to confirm.
↳ The **CDI Communication TCP/IP (Configuration)** window opens.
6. Enter the device address in the **IP address** field: 192.168.1.212 and press **Enter** to confirm.
7. Establish the online connection to the device.

 For additional information, see Operating Instructions BA00027S and BA00059S

User interface

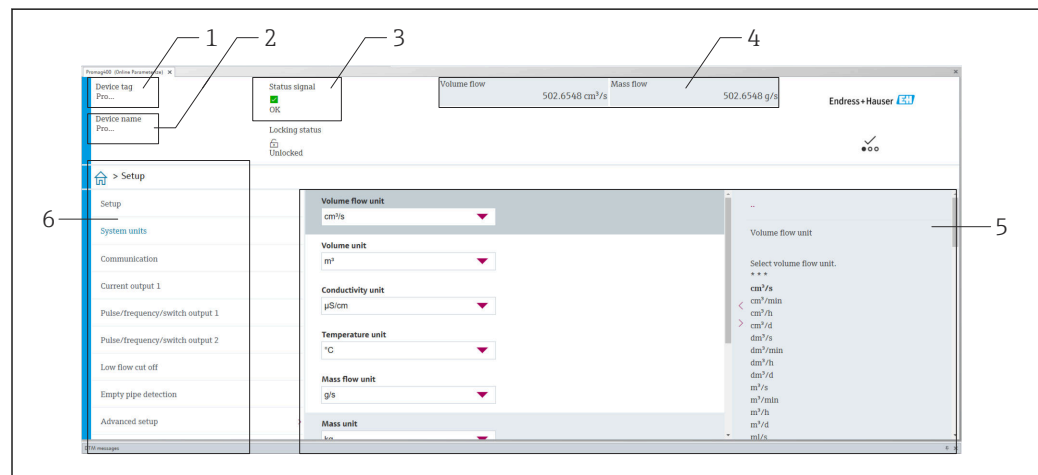

A0008200

- 1 Device name
- 2 Tag name
- 3 Status area with status signal →  132
- 4 Display area for current measured values
- 5 Edit bar with additional functions
- 6 Navigation area with operating menu structure

8.5.3 DeviceCare

Function scope

Tool for connecting and configuring Endress+Hauser field devices.

The fastest way to configure Endress+Hauser field devices is with the dedicated "DeviceCare" tool. Together with the device type managers (DTMs) it presents a convenient, comprehensive solution.

 For details, see Innovation Brochure IN01047S

Source for device description files

See information →  86

8.5.4 Field Xpert SMT70, SMT77

Field Xpert SMT70

The Field Xpert SMT70 tablet PC for device configuration enables mobile plant asset management in hazardous and non-hazardous areas. It is suitable for commissioning and maintenance staff to manage field instruments with a digital communication interface and to record progress.

This tablet PC is designed as an all-in-one solution with a preinstalled driver library and is an easy-to-use, touch-sensitive tool which can be used to manage field instruments throughout their entire life cycle.



- Technical Information TI01342S
- Operating Instructions BA01709S
- Product page: www.endress.com/smt70



Source for device description files: →  86

Field Xpert SMT77

The Field Xpert SMT77 tablet PC for device configuration enables mobile plant asset management in areas categorized as Ex Zone 1.



- Technical Information TI01418S
- Operating Instructions BA01923S
- Product page: www.endress.com/smt77



Source for device description files: →  86

9 System integration

9.1 Overview of device description files

9.1.1 Current version data for the device

Firmware version	02.00.zz	<ul style="list-style-type: none"> ▪ On the title page of the Operating instructions ▪ On the transmitter nameplate ▪ Firmware version Diagnostics → Device information → Firmware version
Release date of firmware version	09.2021	---
Manufacturer ID	0x11	---
Device type ID	0x1562	Device type Diagnostics → Device information → Device type
Profile version	3.02	---



- Protocol-specific data → 180
- Firmware versions of the device → 167

9.1.2 Operating tools

The suitable device description file for the individual operating tools is listed in the table below, along with information on where the file can be acquired.

Operating tool via PROFIBUS protocol	Sources for obtaining device descriptions
FieldCare	<ul style="list-style-type: none"> ▪ www.endress.com → Download Area ▪ CD-ROM (contact Endress+Hauser) ▪ DVD (contact Endress+Hauser)
DeviceCare	<ul style="list-style-type: none"> ▪ www.endress.com → Download Area ▪ CD-ROM (contact Endress+Hauser) ▪ DVD (contact Endress+Hauser)

9.2 Device master file (GSD)

In order to integrate field devices into a bus system, the PROFIBUS system needs a description of the device parameters, such as output data, input data, data format, data volume and supported transmission rate.

These data are available in the device master file (GSD) which is provided to the PROFIBUS Master when the communication system is commissioned. In addition device bit maps, which appear as icons in the network structure, can also be integrated.

With the Profile 3.0 device master file (GSD) it is possible to exchange field devices made by different manufacturers without having to reconfigure.

Generally speaking two different GSD versions are possible with Profile 3.0 and higher.



- Before configuring, the user must decide which GSD should be used to operate the system.
 - The setting can be changed via a Class 2 master.

9.2.1 Manufacturer-specific GSD

This GSD guarantees the unrestricted functionality of the measuring device. Device-specific process parameters and functions are therefore available.

Manufacturer-specific GSD	ID number	File name
PROFIBUS DP	0x1562	EH3x1562.gsd

The fact that the manufacturer-specific GSD should be used is specified in the **Ident number selector** parameter by selecting the **Manufacturer** option.



Where to acquire the manufacturer-specific GSD:

www.endress.com → Download-Area

9.2.2 Profile GSD

Differs in terms of the number of Analog Input blocks (AI) and the measured values. If a system is configured with a Profile GSD, it is possible to exchange devices made by different manufacturers. However, it is essential to ensure that the order of the cyclic process values is correct.

ID number	Supported blocks	Supported channels
0x9740	<ul style="list-style-type: none"> ▪ 1 Analog Input ▪ 1 Totalizer 	<ul style="list-style-type: none"> ▪ Channel Analog Input: volume flow ▪ Channel totalizer: volume flow
0x9741	<ul style="list-style-type: none"> ▪ 2 Analog Input ▪ 1 Totalizer 	<ul style="list-style-type: none"> ▪ Channel Analog Input 1: volume flow ▪ Channel Analog Input 2: mass flow ▪ Channel totalizer: volume flow
0x9742	<ul style="list-style-type: none"> ▪ 3 Analog Input ▪ 1 Totalizer 	<ul style="list-style-type: none"> ▪ Channel Analog Input 1: volume flow ▪ Channel Analog Input 2: mass flow ▪ Channel Analog Input 3: corrected volume flow ▪ Channel totalizer: volume flow

The Profile GSD that is to be used is specified in the **Ident number selector** parameter by selecting the **Profile 0x9740** option, **Profile 0x9741** option or **Profile 0x9742** option.

9.2.3 Compatibility with other Endress+Hauser measuring devices

The Promag 400 PROFIBUS DP guarantees compatibility during cyclic data exchange with the automation system (Class 1 master) for the following measuring devices:

- Promag 50 PROFIBUS DP (Profile version 3.0, ID number 0x1546)
- Promag 53 PROFIBUS DP (Profile version 3.0, ID number 0x1526)

It is possible to replace these measuring devices with a Promag 400 PROFIBUS DP without the need to reconfigure the PROFIBUS network in the automation unit even though the names and ID numbers of the measuring devices differ. Once replaced, the device is either identified automatically (factory setting) or device identification can be set manually.

Automatic identification (factory setting)

The Promag 400 PROFIBUS DP automatically identifies the measuring device configured in the automation system (Promag 50 PROFIBUS DP or Promag 53 PROFIBUS DP) and makes the same input and output data and measured value status information available for cyclic data exchange.

Automatic identification is set in the **Ident number selector** parameter using the **Auto** option (factory setting).

Manual setting

The manual setting is made in the **Ident number selector** parameter via the option Promag 50 (0x1546) or Promag 53 (0x1526).

Afterwards, the Promag 400 PROFIBUS DP makes the same input and output data and measured value status information available for cyclic data exchange.

- i** ■ If the Promag 400 PROFIBUS DP is acyclically configured via an operating program (Class 2 master), access is directly via the block structure or the parameters of the measuring device.
- If parameters have been changed in the device to be replaced (Promag 50 PROFIBUS DP or Promag 53 PROFIBUS DP) (parameter setting no longer corresponds to the original factory setting), these parameters must be changed accordingly in the new replacement Promag 400 PROFIBUS DP via an operating program (Class 2 master).

Example

The setting for low flow cut off has been changed from mass flow (factory setting) to corrected volume flow in a Promag 50 PROFIBUS DP currently in operation. This device is now replaced by a Promag 400 PROFIBUS DP device. After replacing the device, the assignment for the low flow cut off must be changed manually in the Promag 400 PROFIBUS DP, i.e. to corrected volume flow, to ensure the measuring device behaves identically.

Replacing the measuring devices without changing the GSD file and restarting the controller

In the procedure described below, the device can be replaced without interrupting ongoing operation or restarting the controller. However with this procedure the measuring device is not fully integrated!

1. Replace the measuring device Promag 50 PROFIBUS DP or Promag 53 PROFIBUS DP with the Promag 400 PROFIBUS DP.
2. Set the device address: The same device address that was set for the Promag 50, Promag 53 or PROFIBUS DP Profile GSD must be used.
3. Connect the Promag 400 PROFIBUS DP.

If the factory setting had been changed on the replaced device (Promag 50 or Promag 53), the following settings may need to be changed:

1. Configuration of the application-specific parameters.
2. Choice of process variables to be transmitted via the CHANNEL parameter in the Analog Input or Totalizer function block.
3. Setting of the units for the process variables.

9.3 Cyclic data transmission

Cyclic data transmission when using the device master file (GSD).

9.3.1 Block model

The block model shows which input and output data the measuring device makes available for cyclic data exchange. Cyclic data exchange takes place with a PROFIBUS master (Class 1), e.g. a control system.

Measuring device			Control system
Transducer Block	Analog Input block 1 to 4 → 90	Output value AI →	PROFIBUS DP
		Output value TOTAL →	
	Totalizer block 1 to 3 → 90	Controller SETTOT ←	
		Configuration MODETOT ←	
	Analog Output block 1 to 2 → 92	Input values AO ←	
	Discrete Input block 1 to 2 → 93	Output values DI →	
	Discrete Output block 1 to 2 → 94	Input values DO ←	

Defined order of modules

The measuring device works as a modular PROFIBUS slave. In contrast to a compact slave, a modular slave has a variable design and consists of several individual modules. The device master file (GSD) contains a description of the individual modules (input and output data) along with their individual properties.

The modules are permanently assigned to the slots, i.e. when configuring the modules, the order and the arrangement of the modules must be respected.

Slot	Module	Function block
1...4	AI	Analog Input block 1 to 4
5	TOTAL or SETTOT_TOTAL or SETTOT_MODETOT_TOTAL	Totalizer block 1
6		Totalizer block 2
7		Totalizer block 3
8...9	AO	Analog Output block 1 to 2
10...11	DI	Discrete Input block 1 to 2
12...13	DO	Discrete Output block 1 to 2

To optimize the data throughput rate of the PROFIBUS network, it is advisable to only configure modules that are processed in the PROFIBUS master system. If this results in gaps between the configured modules, these gaps must be assigned to the EMPTY_MODULE.

9.3.2 Description of the modules

The data structure is described from the perspective of the PROFIBUS master:

- Input data: Are sent from the measuring device to the PROFIBUS master.
- Output data: Are sent from the PROFIBUS master to the measuring device.

AI module (Analog Input)

Transmit an input variable from the measuring device to the PROFIBUS master (Class 1).

The selected input variable, along with the status, is cyclically transmitted to the PROFIBUS Master (Class 1) via the AI module. The input variable is depicted in the first four bytes in the form of a floating point number as per the IEEE 754 standard. The fifth byte contains standardized status information pertaining to the input variable.

Four Analog Input blocks are available (slot 1 to 4).

Selection: input variable

The input variable can be specified using the CHANNEL parameter.

CHANNEL	Input variable
33122	Volume flow
33093	Corrected volume flow
32961	Mass flow
33101	Temperature ¹⁾
1132	Conductivity
1407	Corrected conductivity ¹⁾
708	Flow velocity
1042	Electronic temperature
3428	Noise ¹⁾
3429	Coil current rise time ¹⁾
3430	Reference electrode potential against PE ¹⁾
3431	Buildup measured value ¹⁾
3432	Test point 1 ¹⁾
3433	Test point 2 ¹⁾
3434	Test point 3 ¹⁾

1) Visible depending on the order options or device settings

Factory setting

Function block	Factory setting
AI 1	Volume flow
AI 2	Mass flow
AI 3	Electronic temperature
AI 4	Flow velocity

Data structure

Input data of Analog Input

Byte 1	Byte 2	Byte 3	Byte 4	Byte 5
Measured value: floating point number (IEEE 754)				Status

TOTAL module

Transmit a totalizer value from the measuring device to the PROFIBUS master (Class 1).

A selected totalizer value, along with the status, is cyclically transmitted to a PROFIBUS Master (Class 1) via the TOTAL module. The totalizer value is depicted in the first four bytes in the form of a floating point number as per the IEEE 754 standard. The fifth byte contains standardized status information pertaining to the totalizer value.

Three Totalizer blocks are available (slot 5 to 7).

Selection: totalizer value

The totalizer value can be specified using the CHANNEL parameter.

CHANNEL	Input variable
33122	Volume flow
33093	Corrected volume flow
32961	Mass flow

Factory setting

Function block	Factory setting: TOTAL
Totalizer 1, 2 and 3	Volume flow

Data structure

Input data of TOTAL

Byte 1	Byte 2	Byte 3	Byte 4	Byte 5
Measured value: floating point number (IEEE 754)				Status

SETTOT_TOTAL module

The module combination consists of the SETTOT and TOTAL functions:

- SETTOT: Control the totalizers via the PROFIBUS master.
- TOTAL: Transmit totalizer value, along with the status, to the PROFIBUS master.

Three Totalizer blocks are available (slot 5 to 7).

Selection: control totalizer

Value SETTOT	Control totalizer
0	Totalize
1	Resetting
2	Adopt totalizer initial setting

Factory setting

Function block	Factory setting: Value SETTOT (meaning)
Totalizer 1, 2 and 3	0 (totalizing)

Data structure

Output data of SETTOT

Byte 1
Control variable 1

Input data of TOTAL

Byte 1	Byte 2	Byte 3	Byte 4	Byte 5
Measured value: floating point number (IEEE 754)				Status

SETTOT_MODETOT_TOTAL module

The module combination consists of the SETTOT, MODETOT and TOTAL functions:

- SETTOT: Control the totalizers via the PROFIBUS master.
- MODETOT: Configure the totalizers via the PROFIBUS master.
- TOTAL: Transmit totalizer value, along with the status, to the PROFIBUS master.

Three Totalizer blocks are available (slot 5 to 7).

Selection: totalizer configuration

MODETOT value	Totalizer configuration
0	Balancing
1	Balance the positive flow
2	Balance the negative flow
3	Stop totalizing

Factory setting

Function block	Factory setting: Value MODETOT (meaning)
Totalizer 1, 2 and 3	0 (balancing)

*Data structure**Output data of SETTOT and MODETOT*

Byte 1	Byte 2
Control variable 1: SETTOT	Control variable 2: MODETOT

Input data of TOTAL

Byte 1	Byte 2	Byte 3	Byte 4	Byte 5
Measured value: floating point number (IEEE 754)				Status

AO module (Analog Output)

Transmit a compensation value from the PROFIBUS master (Class 1) to the measuring device.

A compensation value, along with the status, is cyclically transmitted from the PROFIBUS Master (Class 1) to the measuring device via the AO module. The compensation value is depicted in the first four bytes in the form of a floating point number as per the IEEE 754 standard. The fifth byte contains standardized status information pertaining to the compensation value.

Two Analog Output blocks are available (slot 8 to 9).

Assigned compensation values

A compensation value is permanently assigned to the individual Analog Output blocks.

CHANNEL	Function block	Compensation value
731	AO 1	External density
307	AO 2	External temperature

 The selection is made via: Expert → Sensor → External compensation

Data structure

Output data of Analog Output

Byte 1	Byte 2	Byte 3	Byte 4	Byte 5
Measured value: floating point number (IEEE 754)				Status

DI module (Discrete Input)

Transmit discrete input values from the measuring device to the PROFIBUS master (Class 1). Discrete input values are used by the measuring device to transmit the state of device functions to the PROFIBUS master (Class 1).

The DI module cyclically transmits the discrete input value, along with the status, to the PROFIBUS Master (Class 1). The discrete input value is depicted in the first byte. The second byte contains standardized status information pertaining to the input value.

Two Discrete Input blocks are available (slot 10 to 11).

Selection: device function

The device function can be specified using the CHANNEL parameter.

CHANNEL	Device function	Factory setting: Status (meaning)
894	Empty pipe detection	<ul style="list-style-type: none"> ▪ 0 (device function not active) ▪ 1 (device function active)
895	Low flow cut off	
1430	Status verification ¹⁾	
4086	Buildup detection ²⁾	

- 1) Only available with the Heartbeat Verification application package
- 2) Visible depending on the order options or device settings

Factory setting

Function block	Factory setting
DI 1	Empty pipe detection
DI 2	Low flow cut off

Data structure

Input data of Discrete Input

Byte 1	Byte 2
Discrete	Status

DO module (Discrete Output)

Transmit discrete output values from the PROFIBUS master (Class 1) to the measuring device. Discrete output values are used by the PROFIBUS master (Class 1) to enable and disable device functions.

The DO module cyclically transmits the discrete output value, along with the status, to the measuring device. The discrete output value is depicted in the first byte. The second byte contains standardized status information pertaining to the output value.

Two Discrete Output blocks are available (slot 12 to 13).

Assigned device functions

A device function is permanently assigned to the individual Discrete Output blocks.

CHANNEL	Function block	Device function	Values: control (meaning)
891	DO 1	Flow override	<ul style="list-style-type: none"> ■ 0 (disable device function) ■ 1 (enable device function)
1429	DO 2	Start verification ¹⁾	

1) Only available with the Heartbeat Verification application package

Data structure

Output data of Discrete Output

Byte 1	Byte 2
Discrete	Status

EMPTY_MODULE module

This module is used to assign empty spaces arising from modules not being used in the slots .



The measuring device works as a modular PROFIBUS slave. In contrast to a compact slave, a modular PROFIBUS slave has a variable design and consists of several individual modules. The GSD file contains a description of the individual modules along with their individual properties.

The modules are permanently assigned to the slots. When configuring the modules, it is absolutely essential to observe the sequence/arrangement of the modules. Any gaps between the configured modules must be filled with the EMPTY_MODULE.

10 Commissioning



10.1 Function check

Before commissioning the measuring device:

- ▶ Make sure that the post-installation and post-connection checks have been performed.
 - "Post-installation check" checklist →  40
 - "Post-connection check" checklist →  59

10.2 Switching on the measuring device

- ▶ After a successful function check, switch on the measuring device.
 - ↳ After a successful startup, the local display switches automatically from the startup display to the operational display.

 If nothing appears on the local display or a diagnostic message is displayed, refer to the section on "Diagnostics and troubleshooting" →  126.

10.3 Configuring the device address via software

In the "**Communication**" submenu the device address can be set.



Navigation

"Setup" menu → Communication → Device address

10.3.1 PROFIBUS network

At time of delivery, the measuring device has the following factory setting:

Device address	126
----------------	-----

- 
 - To display the current device address: **Device address** parameter →  99
 - If hardware addressing is active, software addressing is blocked

10.4 Setting the operating language

Factory setting: English or ordered local language

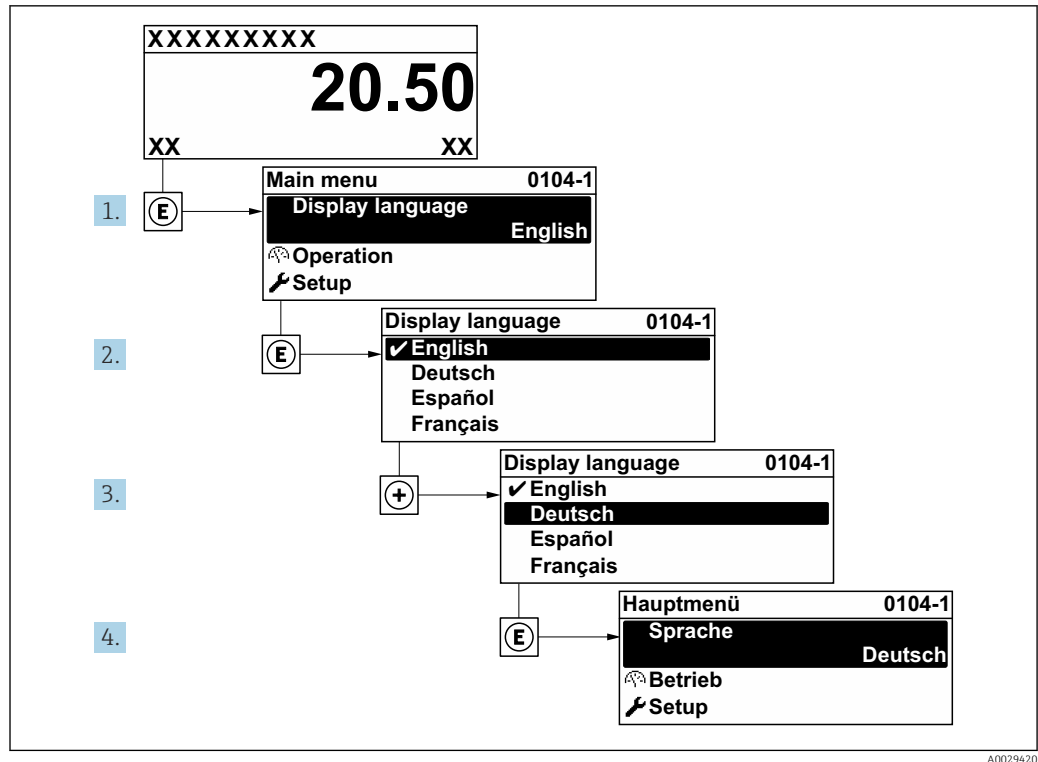

A0029420

21 Taking the example of the local display

10.5 Configuring the measuring device

- The **Setup** menu with its guided wizards contains all the parameters needed for standard operation.
- Navigation to the **Setup** menu

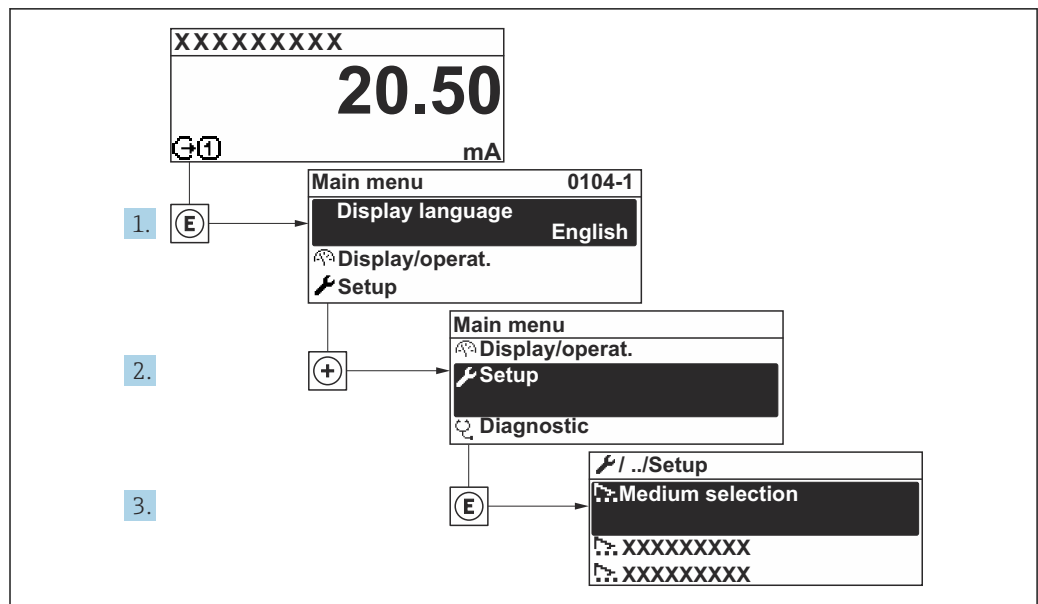

A0032222-EN

22 Taking the example of the local display

Navigation
"Setup" menu

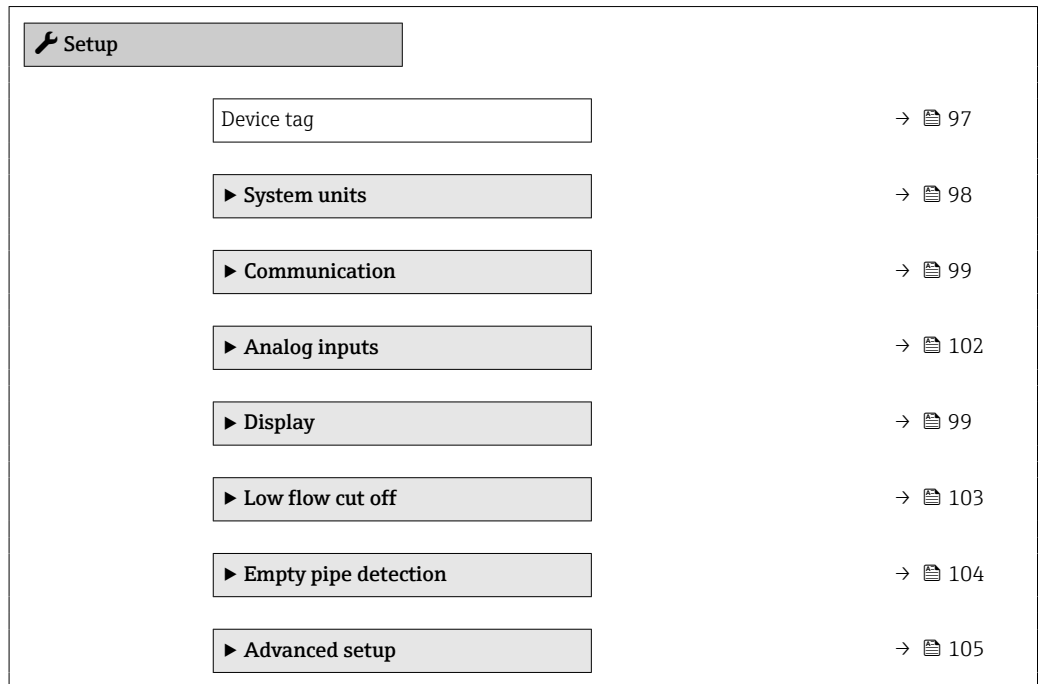

10.5.1 Defining the tag name

To enable fast identification of the measuring point within the system, you can enter a unique designation using the **Device tag** parameter and thus change the factory setting.

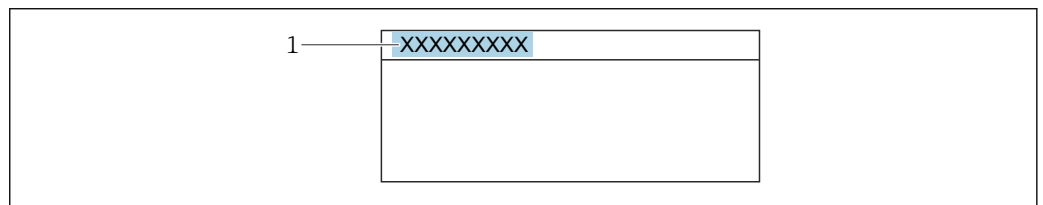

23 Header of the operational display with tag name

1 Tag name

i Enter the tag name in the "FieldCare" operating tool → 84

Navigation
"Setup" menu → Device tag

Parameter overview with brief description

Parameter	Description	User entry	Factory setting
Device tag	Enter the name for the measuring point.	Max. 32 characters, such as letters, numbers or special characters (e.g. @, %, /).	Promag 400 DP







10.5.2 Setting the system units

In the **System units** submenu the units of all the measured values can be set.

 The number of submenus and parameters can vary depending on the device version. Certain submenus and parameters in these submenus are not described in the Operation Instructions. Instead a description is provided in the Special Documentation for the device (→ "Supplementary documentation" section).

Navigation

"Setup" menu → System units

▶ System units	
Volume flow unit	→  98
Volume unit	→  98
Conductivity unit	→  98
Temperature unit	→  98
Mass flow unit	→  99
Mass unit	→  99
Density unit	→  99

Parameter overview with brief description

Parameter	Prerequisite	Description	Selection	Factory setting
Volume flow unit	–	Select volume flow unit. <i>Effect</i> The selected unit applies for: <ul style="list-style-type: none"> ▪ Output ▪ Low flow cut off ▪ Simulation process variable 	Unit choose list	Country-specific: <ul style="list-style-type: none"> ▪ l/h ▪ gal/min (us)
Volume unit	–	Select volume unit.	Unit choose list	Country-specific: <ul style="list-style-type: none"> ▪ m³ ▪ gal (us)
Conductivity unit	The On option is selected in the Conductivity measurement parameter parameter.	Select conductivity unit. <i>Effect</i> The selected unit applies for: Simulation process variable	Unit choose list	µS/cm
Temperature unit	–	Select temperature unit. <i>Effect</i> The selected unit applies for: <ul style="list-style-type: none"> ▪ Maximum value parameter ▪ Minimum value parameter 	Unit choose list	Country-specific: <ul style="list-style-type: none"> ▪ °C ▪ °F

Parameter	Prerequisite	Description	Selection	Factory setting
Mass flow unit	–	Select mass flow unit. <i>Effect</i> The selected unit applies for: <ul style="list-style-type: none"> ▪ Output ▪ Low flow cut off ▪ Simulation process variable 	Unit choose list	Country-specific: <ul style="list-style-type: none"> ▪ kg/h ▪ lb/min
Mass unit	–	Select mass unit.	Unit choose list	Country-specific: <ul style="list-style-type: none"> ▪ kg ▪ lb
Density unit	–	Select density unit. <i>Effect</i> The selected unit applies for: <ul style="list-style-type: none"> ▪ Output ▪ Simulation process variable 	Unit choose list	Country-specific: <ul style="list-style-type: none"> ▪ kg/l ▪ lb/ft³

10.5.3 Configuring communication interface

The **Communication** submenu guides you systematically through all the parameters that have to be configured for selecting and setting the communication interface.

Navigation

"Setup" menu → Communication

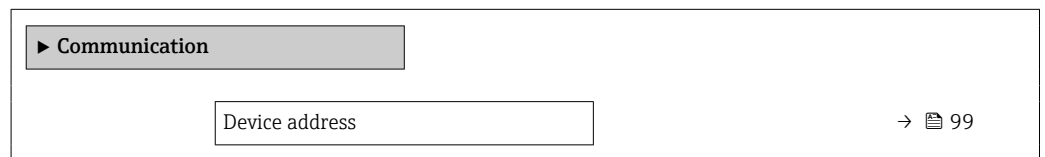

Parameter overview with brief description

Parameter	Description	User entry	Factory setting
Device address	Enter device address.	0 to 126	126





10.5.4 Configuring the local display

The **Display** wizard guides you systematically through all the parameters that can be configured for configuring the local display.

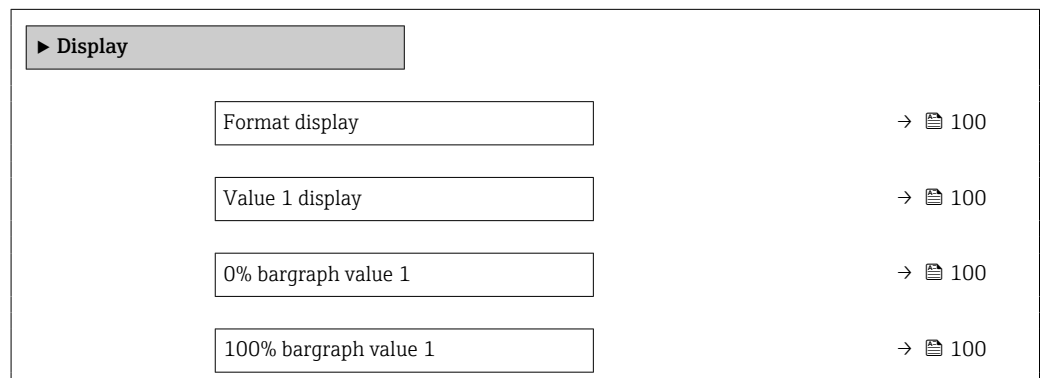

Navigation

"Setup" menu → Display



Value 2 display	→  100
Value 3 display	→  100
0% bargraph value 3	→  101
100% bargraph value 3	→  101
Value 4 display	→  101

Parameter overview with brief description

Parameter	Prerequisite	Description	Selection / User entry	Factory setting
Format display	A local display is provided.	Select how measured values are shown on the display.	<ul style="list-style-type: none"> ▪ 1 value, max. size ▪ 1 bargraph + 1 value ▪ 2 values ▪ 1 value large + 2 values ▪ 4 values 	1 value, max. size
Value 1 display	A local display is provided.	Select the measured value that is shown on the local display.	<ul style="list-style-type: none"> ▪ Volume flow ▪ Mass flow ▪ Corrected volume flow ▪ Flow velocity[*] ▪ Conductivity[*] ▪ Corrected conductivity[*] ▪ Totalizer 1 ▪ Totalizer 2 ▪ Totalizer 3 ▪ Electronics temperature ▪ Noise[*] ▪ Coil current shot time[*] ▪ Reference electrode potential against PE[*] ▪ Build-up measured value[*] ▪ Test point 1 ▪ Test point 2 ▪ Test point 3 	Volume flow
0% bargraph value 1	A local display is provided.	Enter 0% value for bar graph display.	Signed floating-point number	Country-specific: <ul style="list-style-type: none"> ▪ 0 l/h ▪ 0 gal/min (us)
100% bargraph value 1	A local display is provided.	Enter 100% value for bar graph display.	Signed floating-point number	Depends on country and nominal diameter
Value 2 display	A local display is provided.	Select the measured value that is shown on the local display.	For the picklist, see the Value 1 display parameter (→  100)	None
Value 3 display	A local display is provided.	Select the measured value that is shown on the local display.	For the picklist, see the Value 1 display parameter (→  100)	None

Parameter	Prerequisite	Description	Selection / User entry	Factory setting
0% bargraph value 3	A selection was made in the Value 3 display parameter.	Enter 0% value for bar graph display.	Signed floating-point number	Country-specific: <ul style="list-style-type: none"> ▪ 0 l/h ▪ 0 gal/min (us)
100% bargraph value 3	A selection was made in the Value 3 display parameter.	Enter 100% value for bar graph display.	Signed floating-point number	0
Value 4 display	A local display is provided.	Select the measured value that is shown on the local display.	For the picklist, see the Value 1 display parameter (→  100)	None

* Visibility depends on order options or device settings

10.5.5 Configuring the analog inputs

The **Analog inputs** submenu guides the user systematically to the individual **Analog input 1 to n** submenu. From here you get to the parameters of the individual analog input.

Navigation

"Setup" menu → Analog inputs

Parameter overview with brief description

Parameter	Prerequisite	Description	Selection / User entry	Factory setting
Channel	–	Select the process variable.	<ul style="list-style-type: none"> ▪ Volume flow ▪ Mass flow ▪ Corrected volume flow ▪ Flow velocity * ▪ Conductivity * ▪ Corrected conductivity * ▪ Temperature * ▪ Electronics temperature ▪ Noise * ▪ Coil current shot time * ▪ Reference electrode potential against PE * ▪ Build-up index * ▪ Test point 1 ▪ Test point 2 ▪ Test point 3 	Volume flow
PV filter time	–	Specify the time to suppress signal peaks. During the specified time the analog input does not respond to an erratic increase in the process variable.	Positive floating-point number	0
Fail-safe type	–	Select the failure mode.	<ul style="list-style-type: none"> ▪ Fail-safe value ▪ Fallback value ▪ Off 	Off
Fail-safe value	In Fail-safe type parameter, the Fail-safe value option is selected.	Specify the values to be output when an error occurs.	Signed floating-point number	0

* Visibility depends on order options or device settings

10.5.6 Configuring the low flow cut off

The **Low flow cut off** wizard systematically guides the user through all the parameters that must be set to configure low flow cut off.

Navigation

"Setup" menu → Low flow cut off

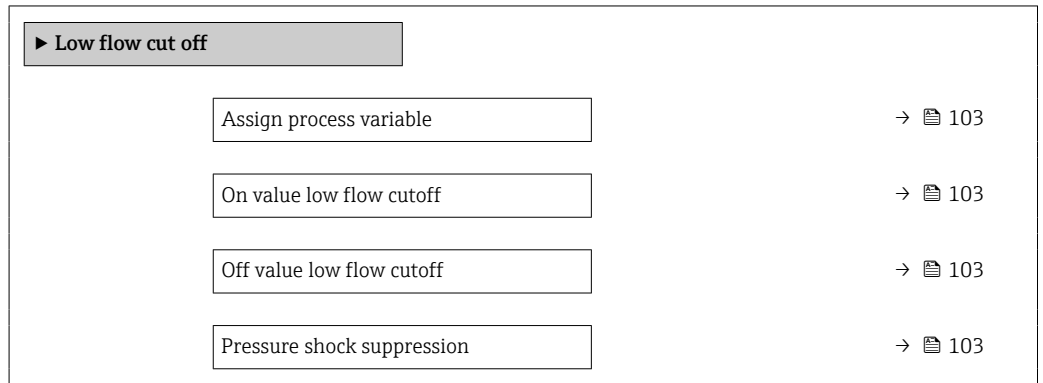

Parameter overview with brief description

Parameter	Prerequisite	Description	Selection / User entry	Factory setting
Assign process variable	–	Select process variable for low flow cut off.	<ul style="list-style-type: none"> ■ Off ■ Volume flow ■ Mass flow ■ Corrected volume flow 	Volume flow
On value low flow cutoff	A process variable is selected in the Assign process variable parameter (→ 103).	Enter on value for low flow cut off.	Positive floating-point number	Depends on country and nominal diameter
Off value low flow cutoff	A process variable is selected in the Assign process variable parameter (→ 103).	Enter off value for low flow cut off.	0 to 100.0 %	50 %
Pressure shock suppression	A process variable is selected in the Assign process variable parameter (→ 103).	Enter time frame for signal suppression (= active pressure shock suppression).	0 to 100 s	0 s





10.5.7 Configuring empty pipe detection

-  The measuring devices are calibrated with water (approx. 500 µS/cm) at the factory. For liquids with a lower conductivity, it is advisable to perform a new full pipe adjustment onsite.
 - It is recommended to perform a new empty pipe adjustment onsite if a cable longer than 50 meters is used.

The **Empty pipe detection** wizard guides you systematically through all the parameters that have to be set for configuring empty pipe detection.

Navigation

"Setup" menu → Empty pipe detection

► Empty pipe detection	
Assign process variable	→  104
New adjustment	→  104
Progress	→  104
Switch point empty pipe detection	→  104
Response time empty pipe detection	→  104

Parameter overview with brief description

Parameter	Prerequisite	Description	Selection / User interface / User entry	Factory setting
Assign process variable	–	Switch empty pipe detection on and off.	<ul style="list-style-type: none"> ▪ Off ▪ On 	Off
New adjustment	The On option is selected in the Empty pipe detection parameter.	Select type of adjustment.	<ul style="list-style-type: none"> ▪ Cancel ▪ Empty pipe adjust ▪ Full pipe adjust 	Cancel
Progress	The On option is selected in the Empty pipe detection parameter.	Shows the progress.	<ul style="list-style-type: none"> ▪ Ok ▪ Busy ▪ Not ok 	–
Switch point empty pipe detection	The On option is selected in the Empty pipe detection parameter.	Enter hysteresis in %, below this value the measuring tube will be detected as empty.	0 to 100 %	50 %
Response time empty pipe detection	A process variable is selected in the Assign process variable parameter (→  104).	Enter the time before diagnostic message S862 'Pipe empty' is displayed for empty pipe detection.	0 to 100 s	1 s

10.6 Advanced settings

The **Advanced setup** submenu together with its submenus contains parameters for specific settings.

Navigation to the "Advanced setup" submenu

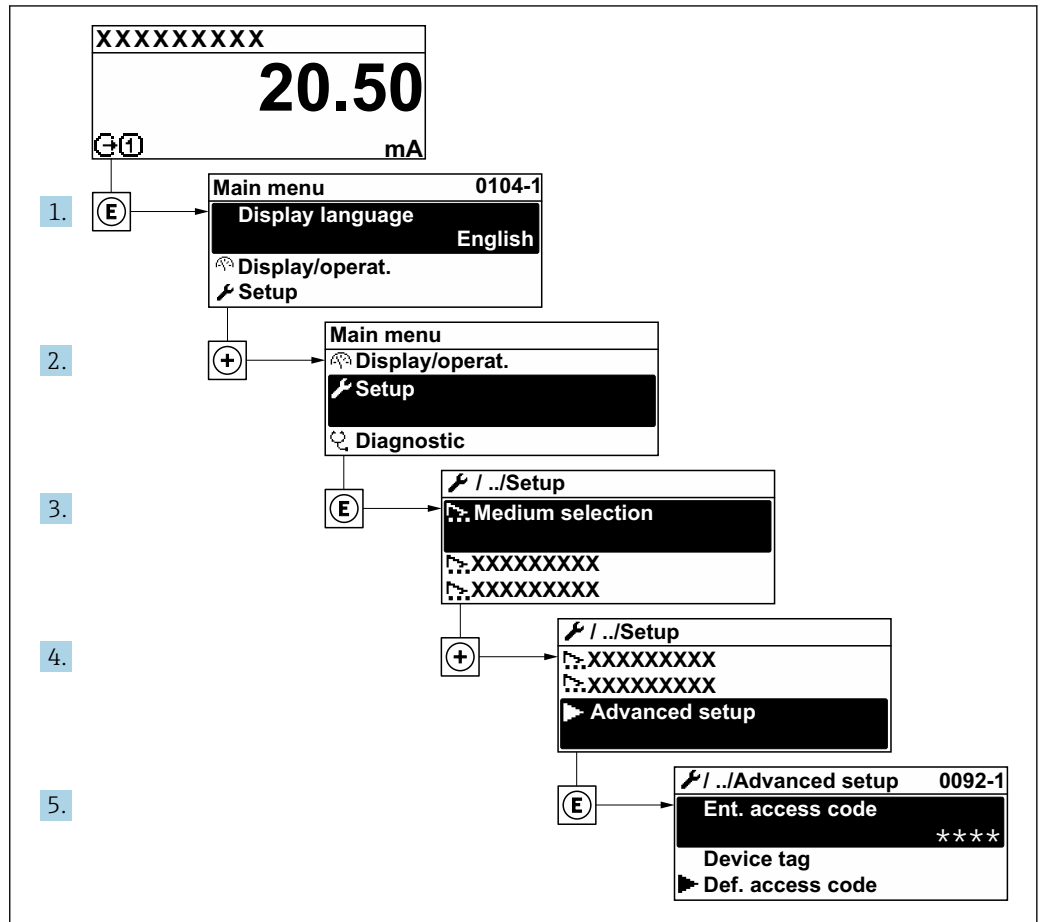

A003223-EN

i The number of submenus and parameters can vary depending on the device version. Certain submenus and parameters in these submenus are not described in the Operation Instructions. Instead a description is provided in the Special Documentation for the device (→ "Supplementary documentation" section).

Navigation

"Setup" menu → Advanced setup

▶ Advanced setup	
Enter access code	→ 106
▶ Sensor adjustment	→ 106
▶ Totalizer 1 to n	→ 106
▶ Display	→ 108

▶ Electrode cleaning cycle	→ 111
▶ WLAN settings	→ 111
▶ Heartbeat setup	
▶ Administration	→ 113

10.6.1 Using the parameter to enter the access code

Navigation

"Setup" menu → Advanced setup

Parameter overview with brief description

Parameter	Description	User entry
Enter access code	Enter access code to disable write protection of parameters.	Max. 16-digit character string comprising numbers, letters and special characters

10.6.2 Carrying out a sensor adjustment

The **Sensor adjustment** submenu contains parameters that pertain to the functionality of the sensor.

Navigation

"Setup" menu → Advanced setup → Sensor adjustment

▶ Sensor adjustment	
Installation direction	→ 106

Parameter overview with brief description

Parameter	Description	Selection	Factory setting
Installation direction	Select sign of flow direction.	<ul style="list-style-type: none"> ▪ Forward flow ▪ Reverse flow 	Forward flow





10.6.3 Configuring the totalizer

In the **"Totalizer 1 to n"** submenu the individual totalizer can be configured.

Navigation

"Setup" menu → Advanced setup → Totalizer 1 to n

▶ Totalizer 1 to n	
Assign process variable	→ 107

Unit totalizer	→  107
Totalizer operation mode	→  107
Control Totalizer 1 to n	→  107
Failure mode	→  107

Parameter overview with brief description

Parameter	Prerequisite	Description	Selection	Factory setting
Assign process variable	–	Select process variable for totalizer.	<ul style="list-style-type: none"> ■ Volume flow ■ Mass flow ■ Corrected volume flow 	Volume flow
Unit totalizer	One of the following options is selected in the Assign process variable parameter: <ul style="list-style-type: none"> ■ Volume flow ■ Mass flow 	Select the unit for the process variable of the totalizer.	Unit choose list	Country-specific: <ul style="list-style-type: none"> ■ m³ ■ ft³
Control Totalizer 1 to n	One of the following options is selected in the Assign process variable parameter: <ul style="list-style-type: none"> ■ Volume flow ■ Mass flow ■ Corrected volume flow 	Control the totalizer value.	<ul style="list-style-type: none"> ■ Totalize ■ Reset + hold ■ Preset + hold 	Totalize
Totalizer operation mode	In the Assign process variable parameter, one of the following options is selected: <ul style="list-style-type: none"> ■ Volume flow ■ Mass flow 	Select totalizer calculation mode.	<ul style="list-style-type: none"> ■ Net flow total ■ Forward flow total ■ Reverse flow total ■ Last valid value 	Net flow total
Failure mode	In the Assign process variable parameter, one of the following options is selected: <ul style="list-style-type: none"> ■ Volume flow ■ Mass flow 	Define the totalizer behavior in the event of a device alarm.	<ul style="list-style-type: none"> ■ Stop ■ Actual value ■ Last valid value 	Actual value

10.6.4 Carrying out additional display configurations



In the **Display** submenu you can set all the parameters associated with the configuration of the local display.

Navigation

"Setup" menu → Advanced setup → Display

► Display	
Format display	→ 109
Value 1 display	→ 109
0% bargraph value 1	→ 109
100% bargraph value 1	→ 109
Decimal places 1	→ 109
Value 2 display	→ 109
Decimal places 2	→ 109
Value 3 display	→ 109
0% bargraph value 3	→ 109
100% bargraph value 3	→ 109
Decimal places 3	→ 110
Value 4 display	→ 110
Decimal places 4	→ 110
Display language	→ 110
Display interval	→ 110
Display damping	→ 110
Header	→ 110
Header text	→ 110
Separator	→ 110
Backlight	→ 110

Parameter overview with brief description

Parameter	Prerequisite	Description	Selection / User entry	Factory setting
Format display	A local display is provided.	Select how measured values are shown on the display.	<ul style="list-style-type: none"> ■ 1 value, max. size ■ 1 bargraph + 1 value ■ 2 values ■ 1 value large + 2 values ■ 4 values 	1 value, max. size
Value 1 display	A local display is provided.	Select the measured value that is shown on the local display.	<ul style="list-style-type: none"> ■ Volume flow ■ Mass flow ■ Corrected volume flow ■ Flow velocity ■ Conductivity* ■ Corrected conductivity* ■ Totalizer 1 ■ Totalizer 2 ■ Totalizer 3 ■ Electronics temperature ■ Noise* ■ Coil current shot time* ■ Reference electrode potential against PE* ■ Build-up measured value* ■ Test point 1 ■ Test point 2 ■ Test point 3 	Volume flow
0% bargraph value 1	A local display is provided.	Enter 0% value for bar graph display.	Signed floating-point number	Country-specific: <ul style="list-style-type: none"> ■ 0 l/h ■ 0 gal/min (us)
100% bargraph value 1	A local display is provided.	Enter 100% value for bar graph display.	Signed floating-point number	Depends on country and nominal diameter
Decimal places 1	A measured value is defined in the Value 1 display parameter.	Select the number of decimal places for the display value.	<ul style="list-style-type: none"> ■ x ■ x.x ■ x.xx ■ x.xxx ■ x.xxxx 	x.xx
Value 2 display	A local display is provided.	Select the measured value that is shown on the local display.	For the picklist, see the Value 1 display parameter (→  100)	None
Decimal places 2	A measured value is specified in the Value 2 display parameter.	Select the number of decimal places for the display value.	<ul style="list-style-type: none"> ■ x ■ x.x ■ x.xx ■ x.xxx ■ x.xxxx 	x.xx
Value 3 display	A local display is provided.	Select the measured value that is shown on the local display.	For the picklist, see the Value 1 display parameter (→  100)	None
0% bargraph value 3	A selection was made in the Value 3 display parameter.	Enter 0% value for bar graph display.	Signed floating-point number	Country-specific: <ul style="list-style-type: none"> ■ 0 l/h ■ 0 gal/min (us)
100% bargraph value 3	A selection was made in the Value 3 display parameter.	Enter 100% value for bar graph display.	Signed floating-point number	0

Parameter	Prerequisite	Description	Selection / User entry	Factory setting
Decimal places 3	A measured value is specified in the Value 3 display parameter.	Select the number of decimal places for the display value.	<ul style="list-style-type: none"> ▪ x ▪ x.x ▪ x.xx ▪ x.xxx ▪ x.xxxx 	x.xx
Value 4 display	A local display is provided.	Select the measured value that is shown on the local display.	For the picklist, see the Value 1 display parameter (→  100)	None
Decimal places 4	A measured value is specified in the Value 4 display parameter.	Select the number of decimal places for the display value.	<ul style="list-style-type: none"> ▪ x ▪ x.x ▪ x.xx ▪ x.xxx ▪ x.xxxx 	x.xx
Display language	A local display is provided.	Set display language.	<ul style="list-style-type: none"> ▪ English ▪ Deutsch ▪ Français ▪ Español ▪ Italiano ▪ Nederlands ▪ Portuguesa ▪ Polski ▪ русский язык (Russian) ▪ Svenska ▪ Türkçe ▪ 中文 (Chinese) ▪ 日本語 (Japanese) ▪ 한국어 (Korean) ▪ العربية (Arabic) * ▪ Bahasa Indonesia ▪ ภาษาไทย (Thai) * ▪ tiếng Việt (Vietnamese) ▪ čeština (Czech) 	English (alternatively, the ordered language is preset in the device)
Display interval	A local display is provided.	Set time measured values are shown on display if display alternates between values.	1 to 10 s	5 s
Display damping	A local display is provided.	Set display reaction time to fluctuations in the measured value.	0.0 to 999.9 s	0.0 s
Header	A local display is provided.	Select header contents on local display.	<ul style="list-style-type: none"> ▪ Device tag ▪ Free text 	Device tag
Header text	In the Header parameter, the Free text option is selected.	Enter display header text.	Max. 12 characters such as letters, numbers or special characters (e.g. @, %, /)	-----
Separator	A local display is provided.	Select decimal separator for displaying numerical values.	<ul style="list-style-type: none"> ▪ . (point) ▪ , (comma) 	. (point)
Backlight	A local display is provided.	Switch the local display backlight on and off.	<ul style="list-style-type: none"> ▪ Disable ▪ Enable 	Enable

* Visibility depends on order options or device settings

10.6.5 Performing electrode cleaning





The **Electrode cleaning circuit** wizard guides the user systematically through all the parameters that have to be set for configuring electrode cleaning.

 The wizard only appears if the device was ordered with an electrode cleaning circuit.

Navigation

"Setup" menu → Advanced setup → Electrode cleaning cycle

▶ **Electrode cleaning cycle**

Electrode cleaning circuit	→  111
ECC duration	→  111
ECC recovery time	→  111
ECC cleaning cycle	→  111
ECC polarity	→  111

Parameter overview with brief description

Parameter	Prerequisite	Description	Selection / User entry / User interface	Factory setting
Electrode cleaning circuit	For the following order code: "Application package", option EC "ECC electrode cleaning"	Switch electrode cleaning on or off.	<ul style="list-style-type: none"> ■ Off ■ On 	Off
ECC duration	For the following order code: "Application package", option EC "ECC electrode cleaning"	Enter the duration of the electrode cleaning cycle.	0.01 to 30 s	2 s
ECC recovery time	For the following order code: "Application package", option EC "ECC electrode cleaning"	Specify the recovery time after electrode cleaning to prevent interference. The output signal values will be frozen for the duration of the recovery.	1 to 600 s	5 s
ECC cleaning cycle	For the following order code: "Application package", option EC "ECC electrode cleaning"	Enter the pause duration between electrode cleaning cycles.	0.5 to 168 h	0.7 h
ECC polarity	For the following order code: "Application package", option EC "ECC electrode cleaning"	Select the polarity of the electrode cleaning circuit.	<ul style="list-style-type: none"> ■ Positive ■ Negative 	Depends on the electrode material: <ul style="list-style-type: none"> ■ Tantalum: Negative option ■ Platinum, Alloy C22, stainless steel: Positive option

10.6.6 WLAN configuration

The **WLAN Settings** submenu guides the user systematically through all the parameters that have to be set for the WLAN configuration.



Navigation

"Setup" menu → Advanced setup → WLAN settings

▶ WLAN settings	
WLAN	→ 112
WLAN mode	→ 112
SSID name	→ 112
Network security	→ 112
Security identification	→ 113
User name	→ 113
WLAN password	→ 113
WLAN IP address	→ 113
WLAN MAC address	→ 113
WLAN passphrase	→ 113
Assign SSID name	→ 113
SSID name	→ 113
Connection state	→ 113
Received signal strength	→ 113

Parameter overview with brief description

Parameter	Prerequisite	Description	Selection / User entry / User interface	Factory setting
WLAN	–	Switch WLAN on and off.	<ul style="list-style-type: none"> ▪ Disable ▪ Enable 	Enable
WLAN mode	–	Select WLAN mode.	WLAN access point	WLAN access point
SSID name	The client is activated.	Enter the user-defined SSID name (max. 32 characters).	–	–
Network security	–	Select the security type of the WLAN network.	<ul style="list-style-type: none"> ▪ Unsecured ▪ WPA2-PSK ▪ EAP-PEAP with MSCHAPv2 * ▪ EAP-PEAP MSCHAPv2 no server authentic. * ▪ EAP-TLS * 	WPA2-PSK

Parameter	Prerequisite	Description	Selection / User entry / User interface	Factory setting
Security identification	–	Select security settings and download these settings via menu Data management > Security > WLAN.	<ul style="list-style-type: none"> ■ Trusted issuer certificate ■ Device certificate ■ Device private key 	–
User name	–	Enter user name.	–	–
WLAN password	–	Enter WLAN password.	–	–
WLAN IP address	–	Enter IP address of the WLAN interface of the device.	4 octet: 0 to 255 (in the particular octet)	192.168.1.212
WLAN MAC address	–	Enter MAC address of the WLAN interface of the device.	Unique 12-digit character string comprising letters and numbers	Each measuring device is given an individual address.
WLAN passphrase	The WPA2-PSK option is selected in the Security type parameter.	Enter the network key (8 to 32 characters).  The network key supplied with the device should be changed during commissioning for security reasons.	8 to 32-digit character string comprising numbers, letters and special characters (without spaces)	Serial number of the measuring device (e.g. L100A802000)
Assign SSID name	–	Select which name will be used for SSID: device tag or user-defined name.	<ul style="list-style-type: none"> ■ Device tag ■ User-defined 	User-defined
SSID name	<ul style="list-style-type: none"> ■ The User-defined option is selected in the Assign SSID name parameter. ■ The WLAN access point option is selected in the WLAN mode parameter. 	Enter the user-defined SSID name (max. 32 characters).  The user-defined SSID name may only be assigned once. If the SSID name is assigned more than once, the devices can interfere with one another.	Max. 32-digit character string comprising numbers, letters and special characters	
Connection state	–	Displays the connection status.	<ul style="list-style-type: none"> ■ Connected ■ Not connected 	Not connected
Received signal strength	–	Shows the received signal strength.	<ul style="list-style-type: none"> ■ Low ■ Medium ■ High 	High

* Visibility depends on order options or device settings

10.6.7 Using parameters for device administration

The **Administration** submenu systematically guides the user through all the parameters that can be used for device administration purposes.

Navigation

"Setup" menu → Advanced setup → Administration

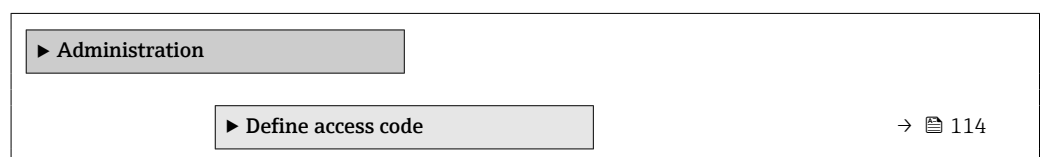

▶ Reset access code

→ 114

Device reset

→ 115

Using the parameter to define the access code

Navigation

"Setup" menu → Advanced setup → Administration → Define access code

▶ Define access code

Define access code

→ 114

Confirm access code

→ 114

Parameter overview with brief description

Parameter	Description	User entry
Define access code	Restrict write-access to parameters to protect the configuration of the device against unintentional changes.	Max. 16-digit character string comprising numbers, letters and special characters
Confirm access code	Confirm the entered access code.	Max. 16-digit character string comprising numbers, letters and special characters

Using the parameter to reset the access code

Navigation

"Setup" menu → Advanced setup → Administration → Reset access code

▶ Reset access code

Operating time

→ 114

Reset access code

→ 114

Parameter overview with brief description

Parameter	Description	User interface / User entry	Factory setting
Operating time	Indicates how long the device has been in operation.	Days (d), hours (h), minutes (m) and seconds (s)	–
Reset access code	Reset access code to factory settings. For a reset code, contact your Endress+Hauser service organization. The reset code can only be entered via: <ul style="list-style-type: none"> ▪ Web browser ▪ DeviceCare, FieldCare (via CDI-RJ45 service interface) ▪ Fieldbus 	Character string comprising numbers, letters and special characters	0x00

Using the parameter to reset the device

Navigation

"Setup" menu → Advanced setup → Administration

Parameter overview with brief description

Parameter	Description	Selection	Factory setting
Device reset	Reset the device configuration - either entirely or in part - to a defined state.	<ul style="list-style-type: none"> ■ Cancel ■ To delivery settings ■ Restart device ■ Restore S-DAT backup * 	Cancel

* Visibility depends on order options or device settings

10.7 Simulation

The **Simulation** submenu enables you to simulate, without a real flow situation, various process variables in the process and the device alarm mode and to verify downstream signal chains (switching valves or closed-control loops).



The parameters displayed depend on:

- The selected device order
- The set operating mode of the pulse/frequency/switch outputs

Navigation

"Diagnostics" menu → Simulation

▶ Simulation

Assign simulation process variable	→ 116
Process variable value	→ 116
Device alarm simulation	→ 116
Diagnostic event category	→ 116
Diagnostic event simulation	→ 116

Parameter overview with brief description

Parameter	Prerequisite	Description	Selection / User entry	Factory setting
Assign simulation process variable	–	Select a process variable for the simulation process that is activated.	<ul style="list-style-type: none"> ▪ Off ▪ Volume flow ▪ Mass flow ▪ Corrected volume flow ▪ Flow velocity * ▪ Conductivity * ▪ Corrected conductivity * ▪ Temperature * 	Off
Process variable value	A process variable is selected in the Assign simulation process variable parameter (→  116).	Enter the simulation value for the selected process variable.	Depends on the process variable selected	0
Device alarm simulation	–	Switch the device alarm on and off.	<ul style="list-style-type: none"> ▪ Off ▪ On 	Off
Diagnostic event category	–	Select a diagnostic event category.	<ul style="list-style-type: none"> ▪ Sensor ▪ Electronics ▪ Configuration ▪ Process 	Process
Diagnostic event simulation	–	Select a diagnostic event to simulate this event.	<ul style="list-style-type: none"> ▪ Off ▪ Diagnostic event picklist (depends on the category selected) 	Off

* Visibility depends on order options or device settings

10.8 Protecting settings from unauthorized access

The following options exist for protecting the configuration of the measuring device from unintentional modification after commissioning:



- Write protection via access code for the local display and Web browser
- Write protection via write protection switch
- Write protection via keypad lock

10.8.1 Write protection via access code

The effects of the user-specific access code are as follows:



- Via local operation, the parameters for the measuring device configuration are write-protected and their values can no longer be changed.
- Device access is protected via the Web browser, as are the parameters for the measuring device configuration.

Defining the access code via local display

1. Navigate to the **Define access code** parameter (→  114).
2. Define a max. 16-digit character string comprising numbers, letters and special characters as the access code.
3. Enter the access code again in the to confirm the code.
 - ↳ The -symbol appears in front of all write-protected parameters.

The device automatically locks the write-protected parameters again if a key is not pressed for 10 minutes in the navigation and editing view. The device locks the write-protected

parameters automatically after 60 s if the user skips back to the operational display mode from the navigation and editing view.

- i
 - If parameter write protection is activated via an access code, it can also only be deactivated via this access code →  74.
 - The user role with which the user is currently logged on via the local display →  74 is indicated by the **Access status display** parameter. Navigation path: Operation → Access status display

Parameters which can always be modified via the local display

Certain parameters that do not affect the measurement are excepted from parameter write protection via the local display. Despite the user-specific access code, they can always be modified, even if the other parameters are locked.

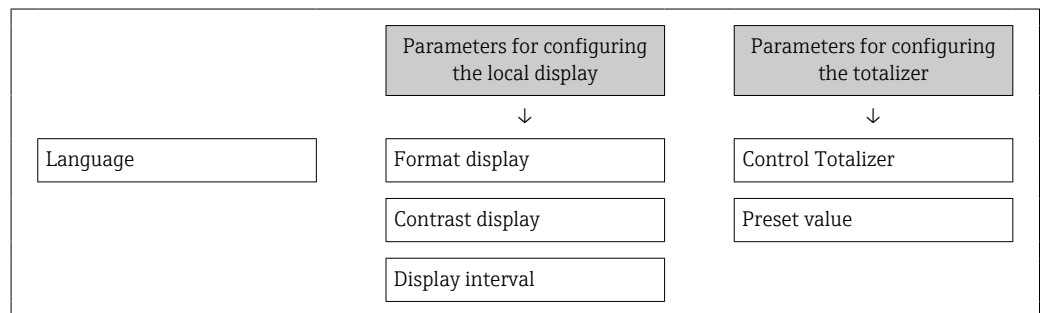

Defining the access code via the Web browser

1. Navigate to the **Define access code** parameter (→  114).
2. Define a max. 16-digit numeric code as an access code.
3. Enter the access code again in the to confirm the code.
 - ↳ The Web browser switches to the login page.

- i
 If no action is performed for 10 minutes, the Web browser automatically returns to the login page.
- i
 - If parameter write protection is activated via an access code, it can also only be deactivated via this access code →  74.
 - The user role with which the user is currently logged on via Web browser is indicated by the **Access status tooling** parameter. Navigation path: Operation → Access status tooling

10.8.2 Write protection via write protection switch

Unlike parameter write protection via a user-specific access code, this allows the user to lock write access to the entire operating menu - apart from the **"Contrast display" parameter**.

The parameter values are now read only and cannot be edited any more (exception **"Contrast display" parameter**):

- Via local display
- Via PROFIBUS DP protocol

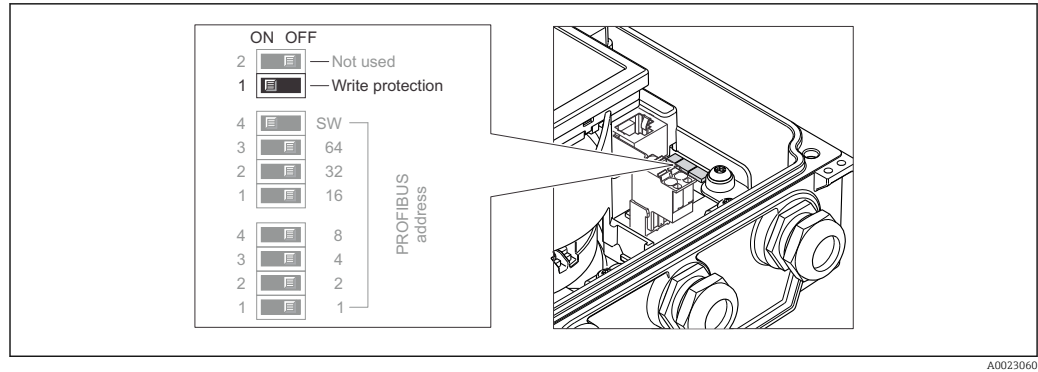

A0023060

1. Loosen the 4 fixing screws on the housing cover and open the housing cover.
2. Setting the write protection switch (WP) on the main electronics module to the **ON** position enables the hardware write protection. Setting the write protection switch (WP) on the main electronics module to the **OFF** position (factory setting) disables the hardware write protection.
 - ↳ If the hardware write protection is enabled: The **Hardware locked** option is displayed in the **Locking status** parameter . In addition, on the local display the  symbol appears in front of the parameters in the header of the operational display and in the navigation view.

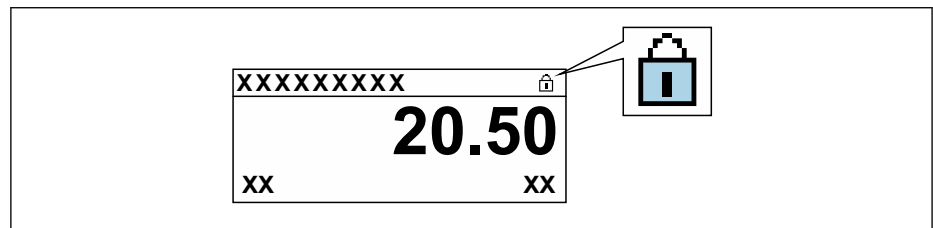

A0029425

If hardware write protection is disabled: No option is displayed in the **Locking status** parameter . On the local display, the  symbol disappears from in front of the parameters in the header of the operational display and in the navigation view.

3. **⚠ WARNING**
Excessive tightening torque applied to the fixing screws!
 Risk of damaging the plastic transmitter.
 - ▶ Tighten the fixing screws as per the tightening torque .

Reverse the removal procedure to reassemble the transmitter.



11 Operation

11.1 Reading the device locking status

Device active write protection: **Locking status** parameter



Operation → Locking status

Function scope of the "Locking status" parameter

Options	Description
None	The access status displayed in the Access status display parameter applies →  74. Only appears on local display.
Hardware locked	The DIP switch for hardware locking is activated on the main electronics module. This locks write access to the parameters (e.g. via local display or operating tool) →  117.
Temporarily locked	Write access to the parameters is temporarily locked on account of internal processes running in the device (e.g. data upload/download, reset etc.). Once the internal processing has been completed, the parameters can be changed once again.



11.2 Adjusting the operating language

 Detailed information:

- To configure the operating language →  95
- For information on the operating languages supported by the measuring device →  198

11.3 Configuring the display

Detailed information:



- On the basic settings for the local display →  99
- On the advanced settings for the local display →  108

11.4 Reading measured values

With the **Measured values** submenu, it is possible to read all the measured values.

Navigation

"Diagnostics" menu → Measured values → Output values

▶ Measured values	
▶ Process variables	→  119
▶ Totalizer 1 to n	→  120

11.4.1 Process variables

The **Process variables** submenu contains all the parameters needed to display the current measured values for each process variable.

Navigation

"Diagnostics" menu → Measured values → Process variables

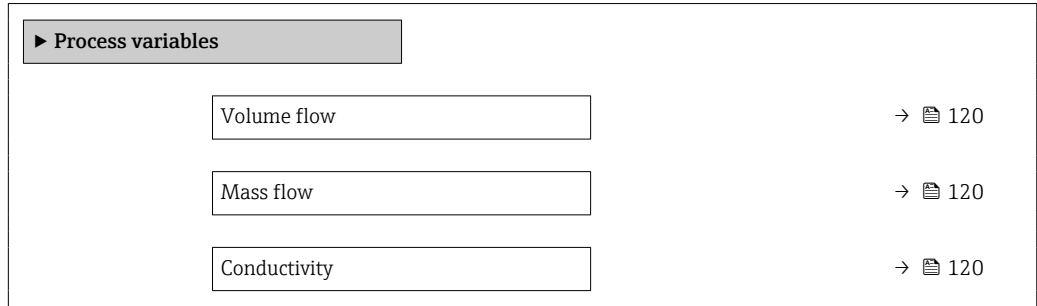

Parameter overview with brief description

Parameter	Prerequisite	Description	User interface
Volume flow	-	Displays the volume flow that is currently measured. <i>Dependency</i> The unit is taken from the Volume flow unit parameter (→ 98).	Signed floating-point number
Mass flow	-	Displays the mass flow that is currently calculated. <i>Dependency</i> The unit is taken from the Mass flow unit parameter (→ 99).	Signed floating-point number
Conductivity	The On option is selected in the Conductivity measurement parameter.	Displays the conductivity that is currently measured. <i>Dependency</i> The unit is taken from the Conductivity unit parameter (→ 98).	Signed floating-point number

11.4.2 Totalizer

The **Totalizer** submenu contains all the parameters needed to display the current measured values for every totalizer.

Navigation

"Diagnostics" menu → Measured values → Totalizer 1 to n

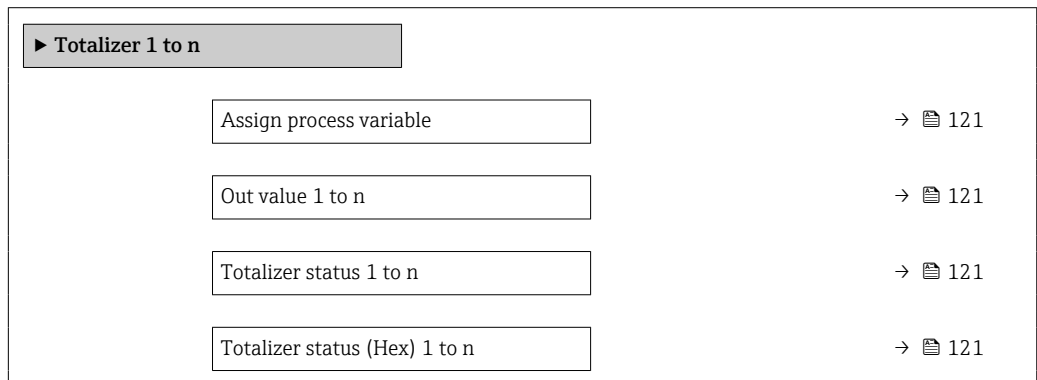



Parameter overview with brief description

Parameter	Prerequisite	Description	Selection / User entry / User interface	Factory setting
Assign process variable	–	Select process variable for totalizer.	<ul style="list-style-type: none"> ■ Volume flow ■ Mass flow ■ Corrected volume flow 	Volume flow
Out value 1 to n	One of the following options is selected in the Assign process variable parameter: <ul style="list-style-type: none"> ■ Volume flow ■ Mass flow ■ Corrected volume flow 	Displays the current totalizer counter value.	Signed floating-point number	0 m ³
Totalizer status 1 to n	–	Displays the current totalizer status.	<ul style="list-style-type: none"> ■ Good ■ Uncertain ■ Bad 	–
Totalizer status (Hex) 1 to n	In Target mode parameter, the Auto option is selected.	Displays the current status value (hex) of the totalizer.	0 to 0xFF	–

11.5 Adapting the measuring device to the process conditions

The following are available for this purpose:

- Basic settings using the **Setup** menu (→  96)
- Advanced settings using the **Advanced setup** submenu (→  105)

11.6 Performing a totalizer reset



The totalizers are reset in the **Operation** submenu:
Control Totalizer 1 to n

Function scope of "Control Totalizer" parameter

Options	Description
Totalize	The totalizer is started.
Reset + hold	The totaling process is stopped and the totalizer is reset to 0.
Preset + hold	The totaling process is stopped and the totalizer is set to its defined start value from the Preset value 1 to n parameter.
Stop totalizing option	Totalizing is stopped.

Navigation

"Operation" menu → Totalizer handling



▶ Totalizer handling	
Control Totalizer 1 to n	→  122
Preset value 1 to n	→  122
Reset all totalizers	→  122

Parameter overview with brief description

Parameter	Prerequisite	Description	Selection / User entry	Factory setting
Control Totalizer 1 to n	One of the following options is selected in the Assign process variable parameter: <ul style="list-style-type: none"> ■ Volume flow ■ Mass flow ■ Corrected volume flow 	Control the totalizer value.	<ul style="list-style-type: none"> ■ Totalize ■ Reset + hold ■ Preset + hold 	Totalize
Preset value 1 to n	-	Specify start value for totalizer.	Signed floating-point number	0 m ³
Reset all totalizers	-	Reset all totalizers to 0 and start.	<ul style="list-style-type: none"> ■ Cancel ■ Reset + totalize 	Cancel

11.7 Showing data logging

The **Extended HistoROM** application package must be enabled in the device (order option) for the **Data logging** submenu to appear. This contains all the parameters for the measured value history.

-  Data logging is also available via:
- Plant Asset Management Tool FieldCare →  83.
 - Web browser

Function scope

- A total of 1000 measured values can be stored
- 4 logging channels
- Adjustable logging interval for data logging
- Display of the measured value trend for each logging channel in the form of a chart

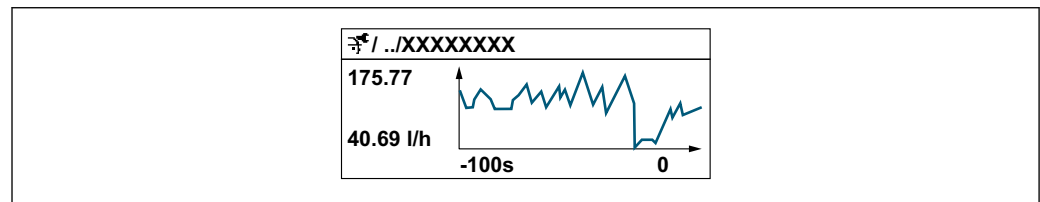

A0034352

- x-axis: depending on the number of channels selected displays 250 to 1000 measured values of a process variable.
- y-axis: displays the approximate measured value span and constantly adapts this to the ongoing measurement.

 If the length of the logging interval or the assignment of the process variables to the channels is changed, the content of the data logging is deleted.

Navigation









"Diagnostics" menu → Data logging

▶ Data logging







Assign channel 1
→  124

Assign channel 2
→  124

Assign channel 3
→  124

Assign channel 4	→  124
Logging interval	→  124
Clear logging data	→  124
Data logging	→  124
Logging delay	→  125
Data logging control	→  125
Data logging status	→  125
Entire logging duration	→  125
▶ Display channel 1	
▶ Display channel 2	
▶ Display channel 3	
▶ Display channel 4	

Parameter overview with brief description

Parameter	Prerequisite	Description	Selection / User entry / User interface	Factory setting
Assign channel 1	The Extended HistoROM application package is available.	Assign process variable to logging channel.	<ul style="list-style-type: none"> ▪ Off ▪ Volume flow ▪ Mass flow ▪ Corrected volume flow ▪ Flow velocity[*] ▪ Conductivity[*] ▪ Corrected conductivity[*] ▪ Temperature ▪ Electronics temperature ▪ Noise[*] ▪ Coil current shot time[*] ▪ Reference electrode potential against PE[*] ▪ Build-up measured value[*] ▪ Test point 1 ▪ Test point 2 ▪ Test point 3 	Off
Assign channel 2	The Extended HistoROM application package is available.  The software options currently enabled are displayed in the Software option overview parameter.	Assign process variable to logging channel.	For the picklist, see the Assign channel 1 parameter (→  124)	Off
Assign channel 3	The Extended HistoROM application package is available.  The software options currently enabled are displayed in the Software option overview parameter.	Assign process variable to logging channel.	For the picklist, see the Assign channel 1 parameter (→  124)	Off
Assign channel 4	The Extended HistoROM application package is available.  The software options currently enabled are displayed in the Software option overview parameter.	Assign process variable to logging channel.	For the picklist, see the Assign channel 1 parameter (→  124)	Off
Logging interval	The Extended HistoROM application package is available.	Define the logging interval for data logging. This value defines the time interval between the individual data points in the memory.	0.1 to 3 600.0 s	1.0 s
Clear logging data	The Extended HistoROM application package is available.	Clear the entire logging data.	<ul style="list-style-type: none"> ▪ Cancel ▪ Clear data 	Cancel
Data logging	–	Select the data logging method.	<ul style="list-style-type: none"> ▪ Overwriting ▪ Not overwriting 	Overwriting

Parameter	Prerequisite	Description	Selection / User entry / User interface	Factory setting
Logging delay	In the Data logging parameter, the Not overwriting option is selected.	Enter the time delay for measured value logging.	0 to 999 h	0 h
Data logging control	In the Data logging parameter, the Not overwriting option is selected.	Start and stop measured value logging.	<ul style="list-style-type: none"> ■ None ■ Delete + start ■ Stop 	None
Data logging status	In the Data logging parameter, the Not overwriting option is selected.	Displays the measured value logging status.	<ul style="list-style-type: none"> ■ Done ■ Delay active ■ Active ■ Stopped 	Done
Entire logging duration	In the Data logging parameter, the Not overwriting option is selected.	Displays the total logging duration.	Positive floating-point number	0 s

* Visibility depends on order options or device settings

12 Diagnostics and troubleshooting

12.1 General troubleshooting

For local display

Error	Possible causes	Remedy
Local display dark and no output signals	Supply voltage does not match that specified on the nameplate.	Apply the correct supply voltage → 50.
Local display dark and no output signals	No contact between connecting cables and terminals.	Check the connection of the cables and correct if necessary.
Local display dark and no output signals	Terminals are not plugged into the main electronics module correctly.	Check terminals.
Local display dark and no output signals	Main electronics module is defective.	Order spare part → 169.
Local display dark and no output signals	The connector between the main electronics module and display module is not plugged in correctly.	Check the connection and correct if necessary.
Local display dark and no output signals	The connecting cable is not plugged in correctly.	1. Check the connection of the electrode cable and correct if necessary. 2. Check the connection of the coil current cable and correct if necessary.
Local display is dark, but signal output is within the valid range	Display is set too bright or too dark.	<ul style="list-style-type: none"> ▪ Set the display brighter by simultaneously pressing \oplus + \square. ▪ Set the display darker by simultaneously pressing \ominus + \square.
Local display is dark, but signal output is within the valid range	Display module is defective.	Order spare part → 169.
Backlighting of local display is red	Diagnostic event with "Alarm" diagnostic behavior has occurred.	Take remedial measures → 136
Text on local display appears in a foreign language and cannot be understood.	Incorrect operating language is configured.	1. Press 2 s \square + \oplus ("home position"). 2. Press \square . 3. Set the desired language in the Display language parameter (→ 110).
Message on local display: "Communication Error" "Check Electronics"	Communication between the display module and the electronics is interrupted.	<ul style="list-style-type: none"> ▪ Check the cable and the connector between the main electronics module and display module. ▪ Order spare part → 169.

For output signals

Error	Possible causes	Solution
Signal output outside the valid range	Main electronics module is defective.	Order spare part → 169.
Device shows correct value on local display, but signal output is incorrect, though in the valid range.	Configuration error	Check and correct the parameter configuration.
Device measures incorrectly.	Configuration error or device is operated outside the application.	1. Check and correct parameter configuration. 2. Observe limit values specified in the "Technical Data".

For access

Error	Possible causes	Remedial action
No write access to parameters	Hardware write protection enabled	Set the write protection switch on the main electronics module to the OFF position → 117.
No write access to parameters	Current user role has limited access authorization	1. Check user role → 74. 2. Enter correct customer-specific access code → 74.
No connection via PROFIBUS DP	PROFIBUS DP bus cable connected incorrectly	Check terminal assignment .
No connection via PROFIBUS DP	PROFIBUS DP cable incorrectly terminated	Check the terminating resistor → 57.
No connection to Web server	Web server disabled	Using the "FieldCare" or "DeviceCare" operating tool, check whether the Web server of the measuring device is enabled, and enable it if necessary → 80.
	Incorrect settings for the Ethernet interface of the computer	1. Check the properties of the Internet protocol (TCP/IP) → 77 → 77. 2. Check the network settings with the IT manager.
No connection to Web server	Incorrect IP address	Check the IP address: 192.168.1.212 → 77 → 77
Web browser frozen and operation no longer possible	Data transfer active	Wait until data transfer or current action is finished.
	Connection lost	1. Check cable connection and power supply. 2. Refresh the Web browser and restart if necessary.
Content of Web browser incomplete or difficult to read	Not using optimum version of Web server.	1. Use the correct Web browser version → 75. 2. Clear the Web browser cache and restart the Web browser.
	Unsuitable view settings.	Change the font size/display ratio of the Web browser.
No or incomplete display of contents in the Web browser	<ul style="list-style-type: none"> ■ JavaScript not enabled ■ JavaScript cannot be enabled 	1. Enable JavaScript. 2. Enter http://192.168.1.212/basic.html as the IP address.
Operation with FieldCare or DeviceCare via CDI-RJ45 service interface (port 8000)	Firewall of computer or network is preventing communication	Depending on the settings of the firewall used on the computer or in the network, the firewall must be adapted or disabled to allow FieldCare/DeviceCare access.
Flashing of firmware with FieldCare or DeviceCare via CDI-RJ45 service interface (via port 8000 or TFTP ports)	Firewall of computer or network is preventing communication	Depending on the settings of the firewall used on the computer or in the network, the firewall must be adapted or disabled to allow FieldCare/DeviceCare access.

12.2 Diagnostic information via light emitting diodes

12.2.1 Transmitter

Different LEDs in the transmitter provide information on the device status.

LED	Color	Meaning
Supply voltage	Off	Supply voltage is off or too low
	Green	Supply voltage is ok
Alarm	Off	Device status is ok
	Flashing red	A device error of diagnostic behavior "Warning" has occurred
	Red	<ul style="list-style-type: none"> ■ A device error of diagnostic behavior "Alarm" has occurred ■ Boot loader is active
Communication	Flashing white	PROFIBUS DP communication is active
Alarm	Green	Measuring device is ok
	Flashing green	Measuring device not configured
	Off	Firmware error
	Red	Main error
	Flashing red	Error
	Flashing red/green	Start measuring device

12.3 Diagnostic information on local display

12.3.1 Diagnostic message

Faults detected by the self-monitoring system of the measuring device are displayed as a diagnostic message in alternation with the operational display.

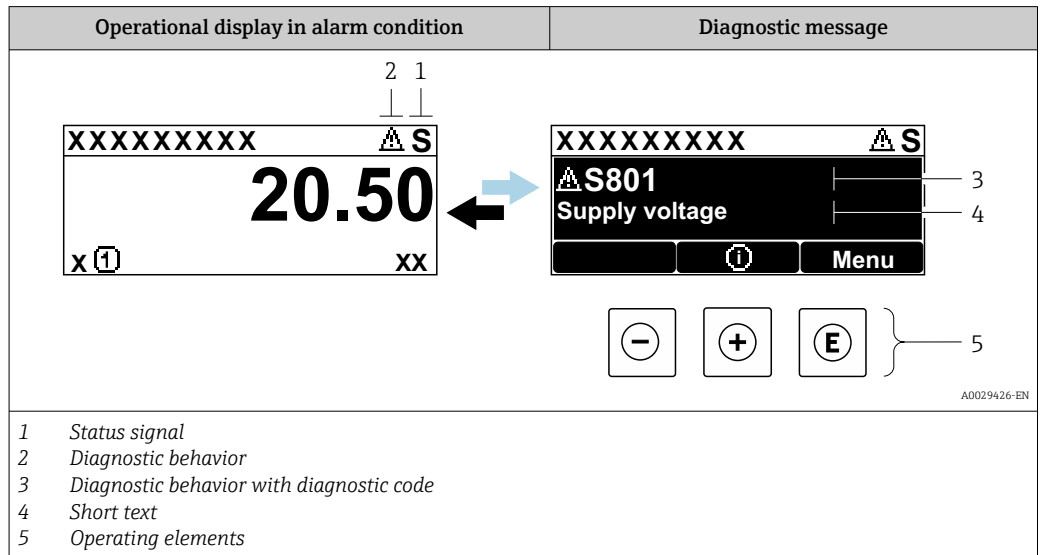

If two or more diagnostic events are pending simultaneously, only the message of the diagnostic event with the highest priority is shown.

- i** Other diagnostic events that have occurred can be displayed in the **Diagnostics** menu:
 - Via parameter → 161
 - Via submenus → 162



Status signals

The status signals provide information on the state and reliability of the device by categorizing the cause of the diagnostic information (diagnostic event).

- i** The status signals are categorized according to VDI/VDE 2650 and NAMUR Recommendation NE 107: F = Failure, C = Function Check, S = Out of Specification, M = Maintenance Required

Symbol	Meaning
F	Failure A device error has occurred. The measured value is no longer valid.
C	Function check The device is in service mode (e.g. during a simulation).
S	Out of specification The device is operated: Outside its technical specification limits (e.g. outside the process temperature range)
M	Maintenance required Maintenance is required. The measured value remains valid.

Diagnostic behavior



Symbol	Meaning
	Alarm <ul style="list-style-type: none"> ▪ Measurement is interrupted. ▪ Signal outputs and totalizers assume the defined alarm condition. ▪ A diagnostic message is generated. ▪ The background lighting changes to red.
	Warning Measurement is resumed. The signal outputs and totalizers are not affected. A diagnostic message is generated.

Diagnostic information

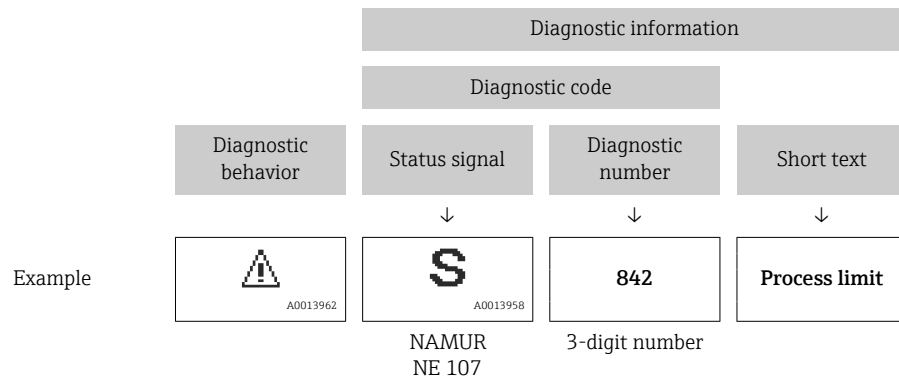
The fault can be identified using the diagnostic information. The short text helps you by providing information about the fault. In addition, the corresponding symbol for the diagnostic behavior is displayed in front of the diagnostic information on the local display.



Operating elements

Key	Meaning
	Plus key <i>In a menu, submenu</i> Opens the message about remedy information.
	Enter key <i>In a menu, submenu</i> Opens the operating menu.

12.3.2 Calling up remedial measures

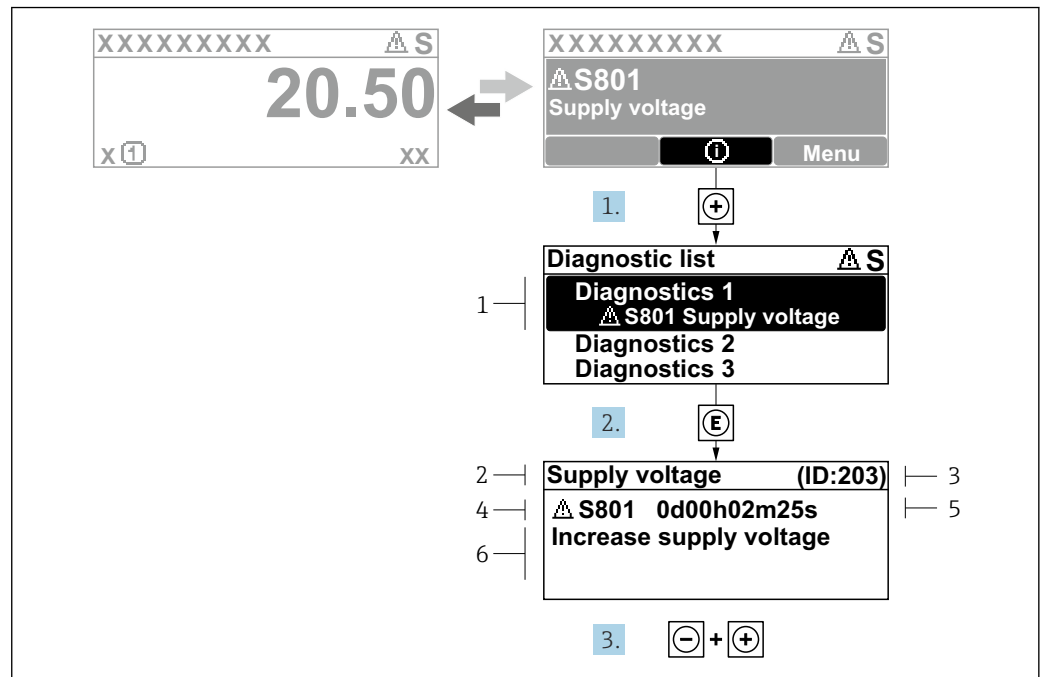

A0029431-EN

24 Message about remedial measures

- 1 Diagnostic information
- 2 Short text
- 3 Service ID
- 4 Diagnostic behavior with diagnostic code
- 5 Operation time of occurrence
- 6 Remedial measures

1. The user is in the diagnostic message.
Press \oplus ($\text{\textcircled{1}}$ symbol).
↳ The **Diagnostic list** submenu opens.
2. Select the desired diagnostic event with \oplus or \ominus and press $\text{\textcircled{E}}$.
↳ The message about the remedial measures opens.
3. Press $\ominus + \oplus$ simultaneously.
↳ The message about the remedial measures closes.

The user is in the **Diagnostics** menu at an entry for a diagnostics event, e.g. in the **Diagnostic list** submenu or **Previous diagnostics** parameter.

1. Press $\text{\textcircled{E}}$.
↳ The message for the remedial measures for the selected diagnostic event opens.
2. Press $\ominus + \oplus$ simultaneously.
↳ The message for the remedial measures closes.

12.4 Diagnostic information in the Web browser

12.4.1 Diagnostic options

Any faults detected by the measuring device are displayed in the Web browser on the home page once the user has logged on.





- 1 Status area with status signal
- 2 Diagnostics information → 130
- 3 Remedial measures with service ID

 In addition, diagnostic events which have occurred can be shown in the **Diagnostics** menu:

- Via parameter → 161
- Via submenu → 162

Status signals

The status signals provide information on the state and reliability of the device by categorizing the cause of the diagnostic information (diagnostic event).

Symbol	Meaning
	Failure A device error has occurred. The measured value is no longer valid.
	Function check The device is in service mode (e.g. during a simulation).
	Out of specification The device is operated: Outside its technical specification limits (e.g. outside the process temperature range)
	Maintenance required Maintenance is required. The measured value is still valid.

 The status signals are categorized in accordance with VDI/VDE 2650 and NAMUR Recommendation NE 107.

12.4.2 Calling up remedy information

Remedy information is provided for every diagnostic event to ensure that problems can be rectified quickly. These measures are displayed in red along with the diagnostic event and the related diagnostic information.

12.5 Diagnostic information in FieldCare or DeviceCare

12.5.1 Diagnostic options

Any faults detected by the measuring device are displayed on the home page of the operating tool once the connection has been established.

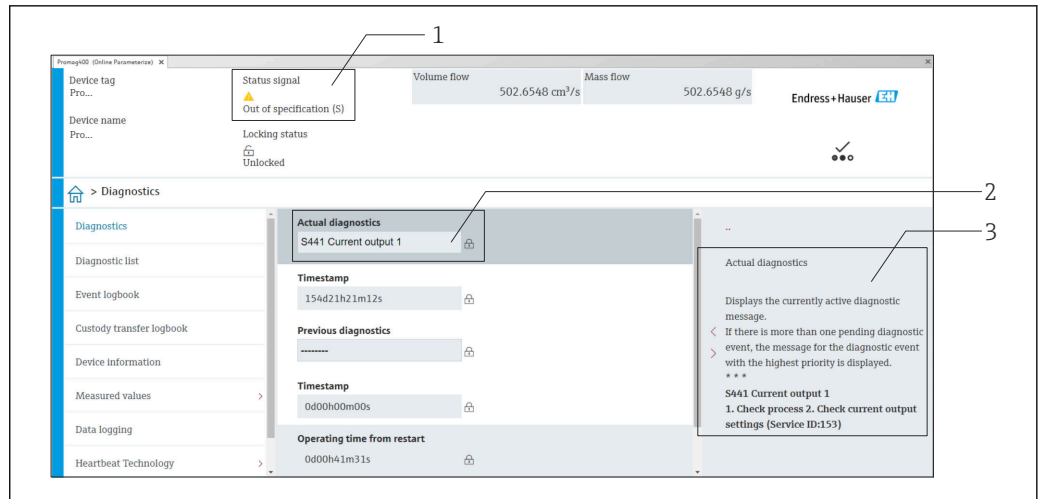

A0008199

- 1 Status area with status signal → 129
- 2 Diagnostics information → 130
- 3 Remedial measures with service ID

i In addition, diagnostic events which have occurred can be shown in the **Diagnostics** menu:

- Via parameter → 161
- Via submenu → 162

Diagnostic information

The fault can be identified using the diagnostic information. The short text helps you by providing information about the fault. In addition, the corresponding symbol for the diagnostic behavior is displayed in front of the diagnostic information on the local display.

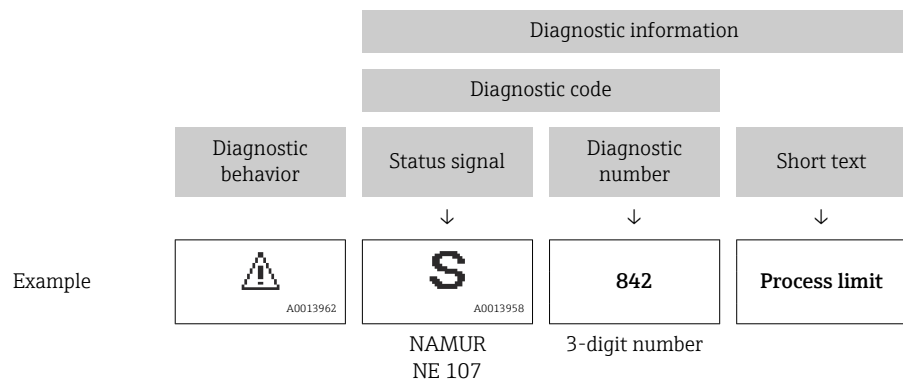

12.5.2 Calling up remedy information

Remedy information is provided for every diagnostic event to ensure that problems can be rectified quickly:

- On the home page
Remedy information is displayed in a separate field below the diagnostics information.
- In the **Diagnostics** menu
Remedy information can be called up in the working area of the user interface.

The user is in the **Diagnostics** menu.

1. Call up the desired parameter.
2. On the right in the working area, mouse over the parameter.
↳ A tool tip with remedy information for the diagnostic event appears.

12.6 Adapting the diagnostic information

12.6.1 Adapting the diagnostic behavior

Each item of diagnostic information is assigned a specific diagnostic behavior at the factory. The user can change this assignment for specific diagnostic information in the **Diagnostic behavior** submenu.

Expert → System → Diagnostic handling → Diagnostic behavior

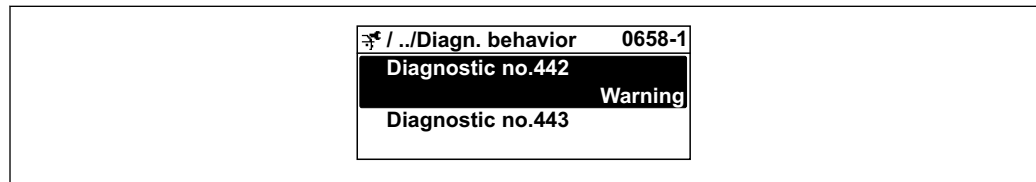

A0019179-EN

Available diagnostic behaviors

The following diagnostic behaviors can be assigned:

Diagnostic behavior	Description
Alarm	The device stops measurement. The totalizers assume the defined alarm condition. A diagnostic message is generated.
Warning	The device continues to measure. The output of measured values via PROFIBUS and totalizers is not affected. A diagnostic message is generated.
Logbook entry only	The device continues to measure. The diagnostic message is only displayed in the Event logbook submenu (Event list submenu) and is not displayed in alternating sequence with the operational display.
Off	The diagnostic event is ignored, and no diagnostic message is generated or entered.

Displaying the measured value status

If the Analog Input, Digital Input and Totalizer function blocks are configured for cyclic data transmission, the device status is coded as per PROFIBUS PA Profile 3.02 Specification and transmitted along with the measured value to the PROFIBUS Master (Class 1) via the coding byte (byte 5). The coding byte is split into three segments: Quality, Quality Substatus and Limits.

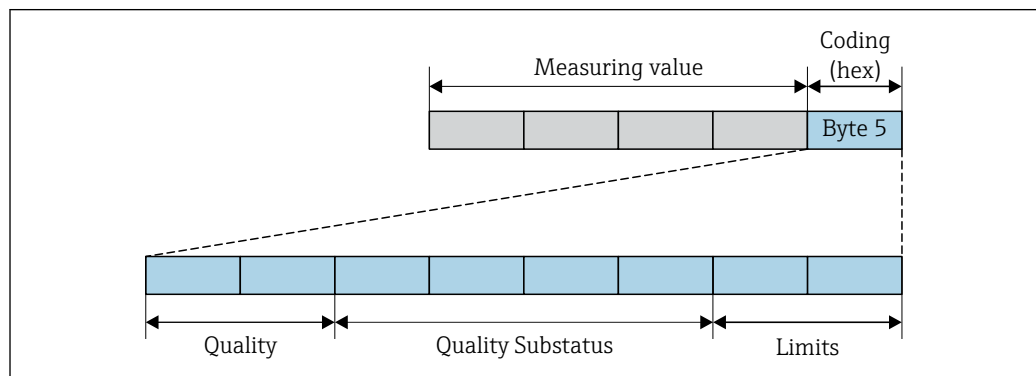

A0032228-EN

25 Structure of the coding byte

The content of the coding byte depends on the configured failure mode in the individual function block. Depending on which failure mode has been configured, status information

in accordance with PROFIBUS PA Profile Specification 3.02 is transmitted to the PROFIBUS Master (Class 1) via the coding byte status information.

Determining the measured value status and device status via the diagnostic behavior

When the diagnostic behavior is assigned, this also changes the measured value status and device status for the diagnostic information. The measured value status and device status depend on the choice of diagnostic behavior and on the group in which the diagnostic information is located.

The diagnostic information is grouped as follows:

- Diagnostic information pertaining to the sensor: diagnostic number 000 to 199
→ 135
- Diagnostic information pertaining to the electronics: diagnostic number 200 to 399
→ 135
- Diagnostic information pertaining to the configuration: diagnostic number 400 to 599
→ 136
- Diagnostic information pertaining to the process: diagnostic number 800 to 999
→ 136

Depending on the group in which the diagnostic information is located, the following measured value status and device status are firmly assigned to the particular diagnostic behavior:

Diagnostic information pertaining to the sensor: diagnostic number 000 to 199

Diagnostic behavior (configurable)	Measured value status (fixed assignment)				Device diagnosis (fixed assignment)
	Quality	Quality Substatus	Coding (hex)	Category (NE107)	
Alarm	BAD	Maintenance alarm	0x24 to 0x27	F (Failure)	Maintenance alarm
Warning	GOOD	Maintenance demanded	0xA8 to 0xAB	M (Maintenance)	Maintenance demanded
Logbook entry only	GOOD	ok	0x80 to 0x8E	-	-
Off					

Diagnostic information pertaining to the electronics: diagnostic number 200 to 399

Diagnostic number 200 to 301, 303 to 399

Diagnostic behavior (configurable)	Measured value status (fixed assignment)				Device diagnostics (fixed assignment)
	Quality	Quality Substatus	Coding (hex)	Category (NE107)	
Alarm	BAD	Maintenance alarm	0x24 to 0x27	F (Failure)	Maintenance alarm
Warning					
Logbook entry only	GOOD	ok	0x80 to 0x8E	-	-
Off					

Diagnostic information 302

Diagnostic behavior (configurable)	Measured value status (fixed assignment)				Device diagnostics (fixed assignment)
	Quality	Quality Substatus	Coding (hex)	Category (NE107)	
Alarm	BAD	Function check, local override	0x3C to 0x3F	C	Function check
Warning	GOOD	Function check	0xBC to 0xBF	-	-

Data logging continues when Heartbeat Verification is started. The signal outputs and totalizers are not affected.

- Signal status: Function check
- Choice of diagnostic behavior: alarm or warning (factory setting)

When Heartbeat verification starts, data logging is interrupted, the last valid measured value is output and the totalizers are stopped.

Diagnostic information pertaining to the configuration: diagnostic number 400 to 599



Diagnostic behavior (configurable)	Measured value status (fixed assignment)				Device diagnosis (fixed assignment)
	Quality	Quality Substatus	Coding (hex)	Category (NE107)	
Alarm	BAD	Function check	0x3C to 0x3F	C (Check)	Function check
Logbook entry only	GOOD	Function check	0xBC to 0xBF	-	Function check
Off					
Logbook entry only	GOOD	ok	0x80 to 0x8E	-	-
Off					

Diagnostic information pertaining to the process: diagnostic number 800 to 999

Diagnostic behavior (configurable)	Measured value status (fixed assignment)				Device diagnosis (fixed assignment)
	Quality	Quality Substatus	Coding (hex)	Category (NE107)	
Alarm	BAD	Process related	0x28 to 0x2B	F (Failure)	Invalid process condition
Warning	UNCERTAIN	Process related	0x78 to 0x7B	S (Out of specification)	Invalid process condition
Logbook entry only	GOOD	ok	0x80 to 0x8E	-	-
Off					

12.7 Overview of diagnostic information

 The amount of diagnostic information and the number of measured variables affected increase if the measuring device has one or more application packages.

 In the case of some items of diagnostic information, the diagnostic behavior can be changed. Adapting the diagnostic information →  134

12.7.1 Diagnostic of sensor

Diagnostic information		Remedy instructions	Influenced measured variables	
No.	Short text			
043	Sensor short circuit	1. Check sensor cable and sensor 2. Execute Heartbeat Verification 3. Replace sensor cable or sensor	<ul style="list-style-type: none"> ▪ Build-up detection option ▪ Build-up index ▪ Conductivity ▪ Corrected conductivity ▪ Density ▪ Electronics temperature ▪ Empty pipe detection option ▪ Flow velocity ▪ Low flow cut off option ▪ Mass flow ▪ Coil current shot time ▪ Reference electrode potential against PE ▪ Noise ▪ Corrected volume flow ▪ Temperature ▪ Status ▪ Volume flow 	
	Measured variable status [from the factory] ¹⁾			
	Quality			Uncertain
	Quality substatus			Maintenance demanded
	Coding (hex)			0x68 to 0x6B
	Status signal			S
	Diagnostic behavior			Warning

1) Diagnostic behavior can be changed. This causes the overall status of the measured variable to change.

Diagnostic information		Remedy instructions	Influenced measured variables	
No.	Short text			
082	Data storage	1. Check module connections 2. Change electronic modules	<ul style="list-style-type: none"> ▪ Build-up detection option ▪ Build-up index ▪ Conductivity ▪ Corrected conductivity ▪ Density ▪ Electronics temperature ▪ Empty pipe detection option ▪ Flow velocity ▪ Low flow cut off option ▪ Mass flow ▪ Coil current shot time ▪ Reference electrode potential against PE ▪ Noise ▪ Corrected volume flow ▪ Temperature ▪ Status ▪ Volume flow 	
	Measured variable status			
	Quality			Bad
	Quality substatus			Maintenance alarm
	Coding (hex)			0x24 to 0x27
	Status signal			F
	Diagnostic behavior			Alarm

Diagnostic information		Remedy instructions	Influenced measured variables	
No.	Short text			
083	Memory content	1. Restart device 2. Restore HistoROM S-DAT backup ('Device reset' parameter) 3. Replace HistoROM S-DAT	<ul style="list-style-type: none"> ■ Build-up detection option ■ Build-up index ■ Conductivity ■ Corrected conductivity ■ Density ■ Electronics temperature ■ Empty pipe detection option ■ Flow velocity ■ Low flow cut off option ■ Mass flow ■ Coil current shot time ■ Reference electrode potential against PE ■ Noise ■ Corrected volume flow ■ Temperature ■ Status ■ Volume flow 	
	Measured variable status			
	Quality			Bad
	Quality substatus			Maintenance alarm
	Coding (hex)			0x24 to 0x27
	Status signal			F
	Diagnostic behavior			Alarm

Diagnostic information		Remedy instructions	Influenced measured variables	
No.	Short text			
168	Build-up limit exceeded	Clean measuring tube	<ul style="list-style-type: none"> ■ Build-up detection option ■ Build-up index ■ Conductivity ■ Corrected conductivity ■ Density ■ Electronics temperature ■ Empty pipe detection option ■ Flow velocity ■ Low flow cut off option ■ Mass flow ■ Corrected volume flow ■ Temperature ■ Status ■ Volume flow 	
	Measured variable status			
	Quality			Uncertain
	Quality substatus			Maintenance demanded
	Coding (hex)			0x68 to 0x6B
	Status signal			M
	Diagnostic behavior			Warning

Diagnostic information		Remedy instructions	Influenced measured variables	
No.	Short text			
169	Conductivity measurement failed	1. Check grounding conditions 2. Deactivate conductivity measurement	<ul style="list-style-type: none"> ■ Build-up detection option ■ Build-up index ■ Conductivity ■ Corrected conductivity ■ Electronics temperature ■ Empty pipe detection option ■ Flow velocity ■ Low flow cut off option ■ Mass flow ■ Coil current shot time ■ Reference electrode potential against PE ■ Noise ■ Corrected volume flow ■ Temperature ■ Status ■ Volume flow 	
	Measured variable status			
	Quality			Bad
	Quality substatus			Maintenance alarm
	Coding (hex)			0x24 to 0x27
	Status signal			M
	Diagnostic behavior			Warning

Diagnostic information		Remedy instructions	Influenced measured variables	
No.	Short text			
170	Coil resistance	Check ambient and process temperature	<ul style="list-style-type: none"> ■ Build-up detection option ■ Build-up index ■ Conductivity ■ Corrected conductivity ■ Density ■ Electronics temperature ■ Empty pipe detection option ■ Flow velocity ■ Low flow cut off option ■ Mass flow ■ Coil current shot time ■ Reference electrode potential against PE ■ Noise ■ Corrected volume flow ■ Temperature ■ Status ■ Volume flow 	
	Measured variable status			
	Quality			Bad
	Quality substatus			Maintenance alarm
	Coding (hex)			0x24 to 0x27
	Status signal			F
	Diagnostic behavior			Alarm

Diagnostic information		Remedy instructions	Influenced measured variables	
No.	Short text			
180	Temperature sensor defective	<ol style="list-style-type: none"> 1. Check sensor connections 2. Replace sensor cable or sensor 3. Turn off temperature measurement 	<ul style="list-style-type: none"> ■ Build-up detection option ■ Build-up index ■ Conductivity ■ Corrected conductivity ■ Density ■ Electronics temperature ■ Empty pipe detection option ■ Flow velocity ■ Low flow cut off option ■ Mass flow ■ Coil current shot time ■ Reference electrode potential against PE ■ Noise ■ Corrected volume flow ■ Temperature ■ Status ■ Volume flow 	
	Measured variable status			
	Quality			Bad
	Quality substatus			Maintenance alarm
	Coding (hex)			0x24 to 0x27
	Status signal			F
	Diagnostic behavior			Warning

Diagnostic information		Remedy instructions	Influenced measured variables	
No.	Short text			
181	Sensor connection	1. Check sensor cable and sensor 2. Execute Heartbeat Verification 3. Replace sensor cable or sensor	<ul style="list-style-type: none"> ▪ Build-up detection option ▪ Build-up index ▪ Conductivity ▪ Corrected conductivity ▪ Density ▪ Electronics temperature ▪ Empty pipe detection option ▪ Flow velocity ▪ Low flow cut off option ▪ Mass flow ▪ Coil current shot time ▪ Reference electrode potential against PE ▪ Noise ▪ Corrected volume flow ▪ Temperature ▪ Status ▪ Volume flow 	
	Measured variable status			
	Quality			Bad
	Quality substatus			Maintenance alarm
	Coding (hex)			0x24 to 0x27
	Status signal			F
	Diagnostic behavior			Alarm

12.7.2 Diagnostic of electronic

Diagnostic information		Remedy instructions	Influenced measured variables	
No.	Short text			
201	Device failure	Restart device	<ul style="list-style-type: none"> ▪ Build-up detection option ▪ Build-up index ▪ Conductivity ▪ Corrected conductivity ▪ Density ▪ Electronics temperature ▪ Empty pipe detection option ▪ Flow velocity ▪ Low flow cut off option ▪ Mass flow ▪ Coil current shot time ▪ Reference electrode potential against PE ▪ Noise ▪ Corrected volume flow ▪ Temperature ▪ Status ▪ Volume flow 	
	Measured variable status			
	Quality			Bad
	Quality substatus			Maintenance alarm
	Coding (hex)			0x24 to 0x27
	Status signal			F
	Diagnostic behavior			Alarm

Diagnostic information		Remedy instructions	Influenced measured variables	
No.	Short text			
242	Software incompatible	1. Check software 2. Flash or change main electronic module	<ul style="list-style-type: none"> ■ Build-up detection option ■ Build-up index ■ Conductivity ■ Corrected conductivity ■ Density ■ Electronics temperature ■ Empty pipe detection option ■ Flow velocity ■ Low flow cut off option ■ Mass flow ■ Coil current shot time ■ Reference electrode potential against PE ■ Noise ■ Corrected volume flow ■ Temperature ■ Status ■ Volume flow 	
	Measured variable status			
	Quality			Bad
	Quality substatus			Maintenance alarm
	Coding (hex)			0x24 to 0x27
	Status signal			F
	Diagnostic behavior			Alarm

Diagnostic information		Remedy instructions	Influenced measured variables	
No.	Short text			
252	Modules incompatible	1. Check electronic modules 2. Check if correct modules are available (e.g. NEx, Ex) 3. Replace electronic modules	<ul style="list-style-type: none"> ■ Build-up detection option ■ Build-up index ■ Conductivity ■ Corrected conductivity ■ Density ■ Electronics temperature ■ Empty pipe detection option ■ Flow velocity ■ Low flow cut off option ■ Mass flow ■ Coil current shot time ■ Reference electrode potential against PE ■ Noise ■ Corrected volume flow ■ Temperature ■ Status ■ Volume flow 	
	Measured variable status			
	Quality			Bad
	Quality substatus			Maintenance alarm
	Coding (hex)			0x24 to 0x27
	Status signal			F
	Diagnostic behavior			Alarm

Diagnostic information		Remedy instructions	Influenced measured variables	
No.	Short text			
252	Modules incompatible	1. Check if correct electronic module is plugged 2. Replace electronic module	<ul style="list-style-type: none"> ▪ Build-up detection option ▪ Build-up index ▪ Conductivity ▪ Corrected conductivity ▪ Density ▪ Electronics temperature ▪ Empty pipe detection option ▪ Flow velocity ▪ Low flow cut off option ▪ Mass flow ▪ Coil current shot time ▪ Reference electrode potential against PE ▪ Noise ▪ Corrected volume flow ▪ Temperature ▪ Status ▪ Volume flow 	
	Measured variable status			
	Quality			Bad
	Quality substatus			Maintenance alarm
	Coding (hex)			0x24 to 0x27
	Status signal			F
	Diagnostic behavior			Alarm

Diagnostic information		Remedy instructions	Influenced measured variables	
No.	Short text			
262	Sensor electronics connection faulty	1. Check/replace connection cable between sensor electronic module (ISEM) and main electr. 2. Check/replace module cartridge, ISEM, main electr.	<ul style="list-style-type: none"> ▪ Build-up detection option ▪ Build-up index ▪ Conductivity ▪ Corrected conductivity ▪ Density ▪ Electronics temperature ▪ Empty pipe detection option ▪ Flow velocity ▪ Low flow cut off option ▪ Mass flow ▪ Coil current shot time ▪ Reference electrode potential against PE ▪ Noise ▪ Corrected volume flow ▪ Temperature ▪ Status ▪ Volume flow 	
	Measured variable status			
	Quality			Bad
	Quality substatus			Maintenance alarm
	Coding (hex)			0x24 to 0x27
	Status signal			F
	Diagnostic behavior			Alarm

Diagnostic information		Remedy instructions	Influenced measured variables	
No.	Short text			
270	Main electronics failure	Change main electronic module	<ul style="list-style-type: none"> ■ Build-up detection option ■ Build-up index ■ Conductivity ■ Corrected conductivity ■ Density ■ Electronics temperature ■ Empty pipe detection option ■ Flow velocity ■ Low flow cut off option ■ Mass flow ■ Coil current shot time ■ Reference electrode potential against PE ■ Noise ■ Corrected volume flow ■ Temperature ■ Status ■ Volume flow 	
	Measured variable status			
	Quality			Bad
	Quality substatus			Maintenance alarm
	Coding (hex)			0x24 to 0x27
	Status signal			F
	Diagnostic behavior			Alarm

Diagnostic information		Remedy instructions	Influenced measured variables	
No.	Short text			
271	Main electronics failure	<ol style="list-style-type: none"> 1. Restart device 2. Change main electronic module 	<ul style="list-style-type: none"> ■ Build-up detection option ■ Build-up index ■ Conductivity ■ Corrected conductivity ■ Density ■ Electronics temperature ■ Empty pipe detection option ■ Flow velocity ■ Low flow cut off option ■ Mass flow ■ Coil current shot time ■ Reference electrode potential against PE ■ Noise ■ Corrected volume flow ■ Temperature ■ Status ■ Volume flow 	
	Measured variable status			
	Quality			Bad
	Quality substatus			Maintenance alarm
	Coding (hex)			0x24 to 0x27
	Status signal			F
	Diagnostic behavior			Alarm

Diagnostic information		Remedy instructions	Influenced measured variables	
No.	Short text			
272	Main electronics failure	Restart device	<ul style="list-style-type: none"> ▪ Build-up detection option ▪ Build-up index ▪ Conductivity ▪ Corrected conductivity ▪ Density ▪ Electronics temperature ▪ Empty pipe detection option ▪ Flow velocity ▪ Low flow cut off option ▪ Mass flow ▪ Coil current shot time ▪ Reference electrode potential against PE ▪ Noise ▪ Corrected volume flow ▪ Temperature ▪ Status ▪ Volume flow 	
	Measured variable status			
	Quality			Bad
	Quality substatus			Maintenance alarm
	Coding (hex)			0x24 to 0x27
	Status signal			F
	Diagnostic behavior			Alarm

Diagnostic information		Remedy instructions	Influenced measured variables	
No.	Short text			
273	Main electronics failure	Change electronics	<ul style="list-style-type: none"> ▪ Build-up detection option ▪ Build-up index ▪ Conductivity ▪ Corrected conductivity ▪ Density ▪ Electronics temperature ▪ Empty pipe detection option ▪ Flow velocity ▪ Low flow cut off option ▪ Mass flow ▪ Coil current shot time ▪ Reference electrode potential against PE ▪ Noise ▪ Corrected volume flow ▪ Temperature ▪ Status ▪ Volume flow 	
	Measured variable status			
	Quality			Bad
	Quality substatus			Maintenance alarm
	Coding (hex)			0x24 to 0x27
	Status signal			F
	Diagnostic behavior			Alarm

Diagnostic information		Remedy instructions	Influenced measured variables	
No.	Short text			
275	I/O module defective	Change I/O module	<ul style="list-style-type: none"> ■ Build-up detection option ■ Build-up index ■ Conductivity ■ Corrected conductivity ■ Density ■ Electronics temperature ■ Empty pipe detection option ■ Flow velocity ■ Low flow cut off option ■ Mass flow ■ Coil current shot time ■ Reference electrode potential against PE ■ Noise ■ Corrected volume flow ■ Temperature ■ Status ■ Volume flow 	
	Measured variable status			
	Quality			Bad
	Quality substatus			Maintenance alarm
	Coding (hex)			0x24 to 0x27
	Status signal			F
	Diagnostic behavior			Alarm

Diagnostic information		Remedy instructions	Influenced measured variables	
No.	Short text			
276	I/O module faulty	<ol style="list-style-type: none"> 1. Restart device 2. Change I/O module 	<ul style="list-style-type: none"> ■ Build-up detection option ■ Build-up index ■ Conductivity ■ Corrected conductivity ■ Density ■ Electronics temperature ■ Empty pipe detection option ■ Flow velocity ■ Low flow cut off option ■ Mass flow ■ Coil current shot time ■ Reference electrode potential against PE ■ Noise ■ Corrected volume flow ■ Temperature ■ Status ■ Volume flow 	
	Measured variable status			
	Quality			Bad
	Quality substatus			Maintenance alarm
	Coding (hex)			0x24 to 0x27
	Status signal			F
	Diagnostic behavior			Alarm

Diagnostic information		Remedy instructions	Influenced measured variables	
No.	Short text			
283	Memory content	Reset device	<ul style="list-style-type: none"> ▪ Build-up detection option ▪ Build-up index ▪ Conductivity ▪ Corrected conductivity ▪ Density ▪ Electronics temperature ▪ Empty pipe detection option ▪ Flow velocity ▪ Low flow cut off option ▪ Mass flow ▪ Coil current shot time ▪ Reference electrode potential against PE ▪ Noise ▪ Corrected volume flow ▪ Temperature ▪ Status ▪ Volume flow 	
	Measured variable status			
	Quality			Bad
	Quality substatus			Maintenance alarm
	Coding (hex)			0x24 to 0x27
	Status signal			F
	Diagnostic behavior			Alarm

Diagnostic information		Remedy instructions	Influenced measured variables	
No.	Short text			
283	Memory content	Restart device	<ul style="list-style-type: none"> ▪ Build-up detection option ▪ Build-up index ▪ Conductivity ▪ Corrected conductivity ▪ Density ▪ Electronics temperature ▪ Empty pipe detection option ▪ Flow velocity ▪ Low flow cut off option ▪ Mass flow ▪ Coil current shot time ▪ Reference electrode potential against PE ▪ Noise ▪ Corrected volume flow ▪ Temperature ▪ Status ▪ Volume flow 	
	Measured variable status			
	Quality			Bad
	Quality substatus			Maintenance alarm
	Coding (hex)			0x24 to 0x27
	Status signal			F
	Diagnostic behavior			Alarm

Diagnostic information		Remedy instructions	Influenced measured variables	
No.	Short text			
302	Device verification in progress	Device verification active, please wait.	<ul style="list-style-type: none"> ■ Build-up detection option ■ Build-up index ■ Conductivity ■ Corrected conductivity ■ Density ■ Electronics temperature ■ Empty pipe detection option ■ Flow velocity ■ Low flow cut off option ■ Mass flow ■ Coil current shot time ■ Reference electrode potential against PE ■ Noise ■ Corrected volume flow ■ Temperature ■ Status ■ Volume flow 	
	Measured variable status [from the factory] ¹⁾			
	Quality			Good
	Quality substatus			Function check
	Coding (hex)			0xBC to 0xBF
	Status signal			C
	Diagnostic behavior			Warning

1) Diagnostic behavior can be changed. This causes the overall status of the measured variable to change.

Diagnostic information		Remedy instructions	Influenced measured variables	
No.	Short text			
311	Electronic failure	1. Do not reset device 2. Contact service	<ul style="list-style-type: none"> ■ Build-up detection option ■ Build-up index ■ Conductivity ■ Corrected conductivity ■ Density ■ Electronics temperature ■ Empty pipe detection option ■ Flow velocity ■ Low flow cut off option ■ Mass flow ■ Coil current shot time ■ Reference electrode potential against PE ■ Noise ■ Corrected volume flow ■ Temperature ■ Status ■ Volume flow 	
	Measured variable status			
	Quality			Bad
	Quality substatus			Maintenance alarm
	Coding (hex)			0x24 to 0x27
	Status signal			M
	Diagnostic behavior			Warning

Diagnostic information		Remedy instructions	Influenced measured variables	
No.	Short text			
372	Sensor electronics (ISEM) faulty	1. Restart device 2. Check if failure recurs 3. Replace sensor electronic module (ISEM)	<ul style="list-style-type: none"> ▪ Build-up detection option ▪ Build-up index ▪ Conductivity ▪ Corrected conductivity ▪ Density ▪ Electronics temperature ▪ Empty pipe detection option ▪ Flow velocity ▪ Low flow cut off option ▪ Mass flow ▪ Coil current shot time ▪ Reference electrode potential against PE ▪ Noise ▪ Corrected volume flow ▪ Temperature ▪ Status ▪ Volume flow 	
	Measured variable status			
	Quality			Bad
	Quality substatus			Maintenance alarm
	Coding (hex)			0x24 to 0x27
	Status signal			F
	Diagnostic behavior			Alarm

Diagnostic information		Remedy instructions	Influenced measured variables	
No.	Short text			
373	Sensor electronics (ISEM) faulty	Transfer data or reset device	<ul style="list-style-type: none"> ▪ Build-up detection option ▪ Build-up index ▪ Conductivity ▪ Corrected conductivity ▪ Density ▪ Electronics temperature ▪ Empty pipe detection option ▪ Flow velocity ▪ Low flow cut off option ▪ Mass flow ▪ Coil current shot time ▪ Reference electrode potential against PE ▪ Noise ▪ Corrected volume flow ▪ Temperature ▪ Status ▪ Volume flow 	
	Measured variable status			
	Quality			Bad
	Quality substatus			Maintenance alarm
	Coding (hex)			0x24 to 0x27
	Status signal			F
	Diagnostic behavior			Alarm

Diagnostic information		Remedy instructions	Influenced measured variables	
No.	Short text			
376	Sensor electronics (ISEM) faulty	1. Replace sensor electronic module (ISEM) 2. Turn off diagnostic message	<ul style="list-style-type: none"> ▪ Build-up detection option ▪ Build-up index ▪ Conductivity ▪ Corrected conductivity ▪ Density ▪ Electronics temperature ▪ Empty pipe detection option ▪ Flow velocity ▪ Low flow cut off option ▪ Mass flow ▪ Coil current shot time ▪ Reference electrode potential against PE ▪ Noise ▪ Corrected volume flow ▪ Temperature ▪ Status ▪ Volume flow 	
	Measured variable status [from the factory] ¹⁾			
	Quality			Bad
	Quality substatus			Maintenance alarm
	Coding (hex)			0x24 to 0x27
	Status signal			S
	Diagnostic behavior			Warning

1) Diagnostic behavior can be changed. This causes the overall status of the measured variable to change.

Diagnostic information		Remedy instructions	Influenced measured variables	
No.	Short text			
377	Sensor electronics (ISEM) faulty	1. Activate empty pipe detection 2. Check partial filled pipe and installation direction 3. Check sensor cabling 4. Deactivate diagnostics 377	<ul style="list-style-type: none"> ▪ Build-up detection option ▪ Build-up index ▪ Conductivity ▪ Corrected conductivity ▪ Density ▪ Electronics temperature ▪ Empty pipe detection option ▪ Flow velocity ▪ Low flow cut off option ▪ Mass flow ▪ Coil current shot time ▪ Reference electrode potential against PE ▪ Noise ▪ Corrected volume flow ▪ Temperature ▪ Status ▪ Volume flow 	
	Measured variable status [from the factory] ¹⁾			
	Quality			Bad
	Quality substatus			Maintenance alarm
	Coding (hex)			0x24 to 0x27
	Status signal			S
	Diagnostic behavior			Warning

1) Diagnostic behavior can be changed. This causes the overall status of the measured variable to change.

Diagnostic information		Remedy instructions	Influenced measured variables	
No.	Short text			
378	Supply voltage ISEM faulty	Check supply voltage to the ISEM	-	
	Measured variable status			
	Quality			Good
	Quality substatus			Ok
	Coding (hex)			0x80 to 0x83
	Status signal			F
Diagnostic behavior	Alarm			

Diagnostic information		Remedy instructions	Influenced measured variables	
No.	Short text			
382	Data storage	1. Insert T-DAT 2. Replace T-DAT	<ul style="list-style-type: none"> ▪ Build-up detection option ▪ Build-up index ▪ Conductivity ▪ Corrected conductivity ▪ Density ▪ Electronics temperature ▪ Empty pipe detection option ▪ Flow velocity ▪ Low flow cut off option ▪ Mass flow ▪ Coil current shot time ▪ Reference electrode potential against PE ▪ Noise ▪ Corrected volume flow ▪ Temperature ▪ Status ▪ Volume flow 	
	Measured variable status			
	Quality			Bad
	Quality substatus			Maintenance alarm
	Coding (hex)			0x24 to 0x27
	Status signal			F
	Diagnostic behavior			Alarm

Diagnostic information		Remedy instructions	Influenced measured variables	
No.	Short text			
383	Memory content	1. Restart device 2. Delete T-DAT via 'Reset device' parameter 3. Replace T-DAT	<ul style="list-style-type: none"> ▪ Build-up detection option ▪ Build-up index ▪ Conductivity ▪ Corrected conductivity ▪ Density ▪ Electronics temperature ▪ Empty pipe detection option ▪ Flow velocity ▪ Low flow cut off option ▪ Mass flow ▪ Coil current shot time ▪ Reference electrode potential against PE ▪ Noise ▪ Corrected volume flow ▪ Temperature ▪ Status ▪ Volume flow 	
	Measured variable status			
	Quality			Bad
	Quality substatus			Maintenance alarm
	Coding (hex)			0x24 to 0x27
	Status signal			F
	Diagnostic behavior			Alarm

Diagnostic information		Remedy instructions	Influenced measured variables	
No.	Short text			
387	HistoROM data faulty		Contact service organization	<ul style="list-style-type: none"> ▪ Build-up detection option ▪ Build-up index ▪ Conductivity ▪ Corrected conductivity ▪ Density ▪ Electronics temperature ▪ Empty pipe detection option ▪ Flow velocity ▪ Low flow cut off option ▪ Mass flow ▪ Corrected volume flow ▪ Temperature ▪ Status ▪ Volume flow
	Measured variable status			
	Quality	Bad		
	Quality substatus	Maintenance alarm		
	Coding (hex)	0x24 to 0x27		
	Status signal	F		
	Diagnostic behavior	Alarm		

Diagnostic information		Remedy instructions	Influenced measured variables	
No.	Short text			
512	Sensor electronics (ISEM) faulty		1. Check ECC recovery time 2. Turn off ECC	<ul style="list-style-type: none"> ▪ Build-up detection option ▪ Build-up index ▪ Conductivity ▪ Corrected conductivity ▪ Density ▪ Electronics temperature ▪ Empty pipe detection option ▪ Flow velocity ▪ Low flow cut off option ▪ Mass flow ▪ Coil current shot time ▪ Reference electrode potential against PE ▪ Noise ▪ Corrected volume flow ▪ Temperature ▪ Status ▪ Volume flow
	Measured variable status			
	Quality	Bad		
	Quality substatus	Maintenance alarm		
	Coding (hex)	0x24 to 0x27		
	Status signal	F		
	Diagnostic behavior	Alarm		

12.7.3 Diagnostic of configuration

Diagnostic information		Remedy instructions	Influenced measured variables	
No.	Short text			
410	Data transfer	1. Check connection 2. Retry data transfer	<ul style="list-style-type: none"> ▪ Build-up detection option ▪ Build-up index ▪ Conductivity ▪ Corrected conductivity ▪ Density ▪ Electronics temperature ▪ Empty pipe detection option ▪ Flow velocity ▪ Low flow cut off option ▪ Mass flow ▪ Coil current shot time ▪ Reference electrode potential against PE ▪ Noise ▪ Corrected volume flow ▪ Temperature ▪ Status ▪ Volume flow 	
	Measured variable status			
	Quality			Bad
	Quality substatus			Maintenance alarm
	Coding (hex)			0x24 to 0x27
	Status signal			F
	Diagnostic behavior			Alarm

Diagnostic information		Remedy instructions	Influenced measured variables	
No.	Short text			
412	Processing download	Download active, please wait	<ul style="list-style-type: none"> ▪ Build-up detection option ▪ Build-up index ▪ Conductivity ▪ Corrected conductivity ▪ Density ▪ Electronics temperature ▪ Empty pipe detection option ▪ Flow velocity ▪ Low flow cut off option ▪ Mass flow ▪ Coil current shot time ▪ Reference electrode potential against PE ▪ Noise ▪ Corrected volume flow ▪ Temperature ▪ Status ▪ Volume flow 	
	Measured variable status			
	Quality			Uncertain
	Quality substatus			Initial value
	Coding (hex)			0x4C to 0x4F
	Status signal			C
	Diagnostic behavior			Warning

Diagnostic information		Remedy instructions	Influenced measured variables	
No.	Short text			
431	Trim 1	Carry out trim	-	
	Measured variable status			
	Quality			Good
	Quality substatus			Ok
	Coding (hex)			0x80 to 0x83
	Status signal			C
	Diagnostic behavior			Warning

Diagnostic information		Remedy instructions	Influenced measured variables
No.	Short text		
437	Configuration incompatible		Restart device <ul style="list-style-type: none"> ■ Build-up detection option ■ Build-up index ■ Conductivity ■ Corrected conductivity ■ Density ■ Electronics temperature ■ Empty pipe detection option ■ Flow velocity ■ Low flow cut off option ■ Mass flow ■ Coil current shot time ■ Reference electrode potential against PE ■ Noise ■ Corrected volume flow ■ Temperature ■ Status ■ Volume flow
	Measured variable status		
	Quality	Bad	
	Quality substatus	Maintenance alarm	
	Coding (hex)	0x24 to 0x27	
	Status signal	F	
	Diagnostic behavior	Alarm	

Diagnostic information		Remedy instructions	Influenced measured variables
No.	Short text		
438	Dataset		<ol style="list-style-type: none"> 1. Check data set file 2. Check device configuration 3. Up- and download new configuration <ul style="list-style-type: none"> ■ Build-up detection option ■ Build-up index ■ Conductivity ■ Corrected conductivity ■ Density ■ Electronics temperature ■ Empty pipe detection option ■ Flow velocity ■ Low flow cut off option ■ Mass flow ■ Coil current shot time ■ Reference electrode potential against PE ■ Noise ■ Corrected volume flow ■ Temperature ■ Status ■ Volume flow
	Measured variable status		
	Quality	Uncertain	
	Quality substatus	Maintenance demanded	
	Coding (hex)	0x68 to 0x6B	
	Status signal	M	
	Diagnostic behavior	Warning	

Diagnostic information		Remedy instructions	Influenced measured variables	
No.	Short text			
453	Flow override	Deactivate flow override	<ul style="list-style-type: none"> ▪ Build-up detection option ▪ Build-up index ▪ Conductivity ▪ Corrected conductivity ▪ Density ▪ Electronics temperature ▪ Empty pipe detection option ▪ Flow velocity ▪ Low flow cut off option ▪ Mass flow ▪ Coil current shot time ▪ Reference electrode potential against PE ▪ Noise ▪ Corrected volume flow ▪ Temperature ▪ Status ▪ Volume flow 	
	Measured variable status			
	Quality			Good
	Quality substatus			Function check
	Coding (hex)			0xBC to 0xBF
	Status signal			C
	Diagnostic behavior			Warning

Diagnostic information		Remedy instructions	Influenced measured variables	
No.	Short text			
482	FB not Auto/Cas	Set Block in AUTO mode	-	
	Measured variable status			
	Quality			Good
	Quality substatus			Ok
	Coding (hex)			0x80 to 0x83
	Status signal			F
	Diagnostic behavior			Alarm

Diagnostic information		Remedy instructions	Influenced measured variables	
No.	Short text			
484	Failure mode simulation	Deactivate simulation	<ul style="list-style-type: none"> ▪ Build-up detection option ▪ Build-up index ▪ Conductivity ▪ Corrected conductivity ▪ Density ▪ Electronics temperature ▪ Empty pipe detection option ▪ Flow velocity ▪ Low flow cut off option ▪ Mass flow ▪ Coil current shot time ▪ Reference electrode potential against PE ▪ Noise ▪ Corrected volume flow ▪ Temperature ▪ Status ▪ Volume flow 	
	Measured variable status			
	Quality			Bad
	Quality substatus			Function check
	Coding (hex)			0x3C to 0x3F
	Status signal			C
	Diagnostic behavior			Alarm

Diagnostic information		Remedy instructions	Influenced measured variables	
No.	Short text			
485	Measured variable simulation	Deactivate simulation	<ul style="list-style-type: none"> ■ Build-up detection option ■ Build-up index ■ Conductivity ■ Corrected conductivity ■ Density ■ Electronics temperature ■ Empty pipe detection option ■ Flow velocity ■ Low flow cut off option ■ Mass flow ■ Coil current shot time ■ Reference electrode potential against PE ■ Noise ■ Corrected volume flow ■ Temperature ■ Status ■ Volume flow 	
	Measured variable status			
	Quality			Good
	Quality substatus			Function check
	Coding (hex)			0xBC to 0xBF
	Status signal			C
	Diagnostic behavior			Warning

Diagnostic information		Remedy instructions	Influenced measured variables	
No.	Short text			
495	Diagnostic event simulation	Deactivate simulation	-	
	Measured variable status			
	Quality			Good
	Quality substatus			Ok
	Coding (hex)			0x80 to 0x83
	Status signal			C
	Diagnostic behavior			Warning

Diagnostic information		Remedy instructions	Influenced measured variables	
No.	Short text			
497	Simulation block output	Deactivate simulation	-	
	Measured variable status			
	Quality			Good
	Quality substatus			Ok
	Coding (hex)			0x80 to 0x83
	Status signal			C
	Diagnostic behavior			Warning

Diagnostic information		Remedy instructions	Influenced measured variables	
No.	Short text			
511	ISEM settings faulty	1. Check measuring period and integration time 2. Check sensor properties	<ul style="list-style-type: none"> ▪ Build-up detection option ▪ Build-up index ▪ Conductivity ▪ Corrected conductivity ▪ Density ▪ Electronics temperature ▪ Empty pipe detection option ▪ Flow velocity ▪ Low flow cut off option ▪ Mass flow ▪ Coil current shot time ▪ Reference electrode potential against PE ▪ Noise ▪ Corrected volume flow ▪ Temperature ▪ Status ▪ Volume flow 	
	Measured variable status			
	Quality			Bad
	Quality substatus			Maintenance alarm
	Coding (hex)			0x24 to 0x27
	Status signal			C
	Diagnostic behavior			Alarm

Diagnostic information		Remedy instructions	Influenced measured variables	
No.	Short text			
530	Electrode cleaning is running	Turn off ECC	<ul style="list-style-type: none"> ▪ Build-up detection option ▪ Build-up index ▪ Conductivity ▪ Corrected conductivity ▪ Density ▪ Electronics temperature ▪ Empty pipe detection option ▪ Flow velocity ▪ Low flow cut off option ▪ Mass flow ▪ Coil current shot time ▪ Reference electrode potential against PE ▪ Noise ▪ Corrected volume flow ▪ Temperature ▪ Status ▪ Volume flow 	
	Measured variable status			
	Quality			Good
	Quality substatus			Function check
	Coding (hex)			0xBC to 0xBF
	Status signal			C
	Diagnostic behavior			Warning

Diagnostic information		Remedy instructions	Influenced measured variables	
No.	Short text			
531	Empty pipe adjustment faulty	Execute EPD adjustment	<ul style="list-style-type: none"> ▪ Build-up detection option ▪ Build-up index ▪ Conductivity ▪ Corrected conductivity ▪ Empty pipe detection option ▪ Flow velocity ▪ Low flow cut off option ▪ Mass flow ▪ Coil current shot time ▪ Reference electrode potential against PE ▪ Noise ▪ Corrected volume flow ▪ Status ▪ Volume flow 	
	Measured variable status [from the factory] ¹⁾			
	Quality			Bad
	Quality substatus			Maintenance alarm
	Coding (hex)			0x24 to 0x27
	Status signal			S
	Diagnostic behavior			Warning

1) Diagnostic behavior can be changed. This causes the overall status of the measured variable to change.

Diagnostic information		Remedy instructions	Influenced measured variables	
No.	Short text			
537	Configuration	1. Check IP addresses in network 2. Change IP address	-	
	Measured variable status			
	Quality			Good
	Quality substatus			Function check
	Coding (hex)			0xBC to 0xBF
	Status signal			F
	Diagnostic behavior			Warning

12.7.4 Diagnostic of process

Diagnostic information		Remedy instructions	Influenced measured variables	
No.	Short text			
832	Electronics temperature too high	Reduce ambient temperature	<ul style="list-style-type: none"> ▪ Build-up detection option ▪ Build-up index ▪ Conductivity ▪ Corrected conductivity ▪ Density ▪ Electronics temperature ▪ Empty pipe detection option ▪ Flow velocity ▪ Low flow cut off option ▪ Mass flow ▪ Coil current shot time ▪ Reference electrode potential against PE ▪ Noise ▪ Corrected volume flow ▪ Temperature ▪ Status ▪ Volume flow 	
	Measured variable status [from the factory] ¹⁾			
	Quality			Bad
	Quality substatus			Process related
	Coding (hex)			0x28 to 0x2B
	Status signal			S
	Diagnostic behavior			Warning

1) Diagnostic behavior can be changed. This causes the overall status of the measured variable to change.

Diagnostic information		Remedy instructions	Influenced measured variables	
No.	Short text			
833	Electronics temperature too low	Increase ambient temperature	<ul style="list-style-type: none"> ▪ Build-up detection option ▪ Build-up index ▪ Conductivity ▪ Corrected conductivity ▪ Density ▪ Electronics temperature ▪ Empty pipe detection option ▪ Flow velocity ▪ Low flow cut off option ▪ Mass flow ▪ Coil current shot time ▪ Reference electrode potential against PE ▪ Noise ▪ Corrected volume flow ▪ Temperature ▪ Status ▪ Volume flow 	
	Measured variable status [from the factory] ¹⁾			
	Quality			Bad
	Quality substatus			Process related
	Coding (hex)			0x28 to 0x2B
	Status signal			S
	Diagnostic behavior			Warning

1) Diagnostic behavior can be changed. This causes the overall status of the measured variable to change.

Diagnostic information		Remedy instructions	Influenced measured variables	
No.	Short text			
834	Process temperature too high	Reduce process temperature	<ul style="list-style-type: none"> ▪ Build-up detection option ▪ Build-up index ▪ Conductivity ▪ Corrected conductivity ▪ Electronics temperature ▪ Empty pipe detection option ▪ Flow velocity ▪ Low flow cut off option ▪ Mass flow ▪ Coil current shot time ▪ Reference electrode potential against PE ▪ Noise ▪ Corrected volume flow ▪ Temperature ▪ Status ▪ Volume flow 	
	Measured variable status [from the factory] ¹⁾			
	Quality			Uncertain
	Quality substatus			Process related
	Coding (hex)			0x78 to 0x7B
	Status signal			S
	Diagnostic behavior			Warning

1) Diagnostic behavior can be changed. This causes the overall status of the measured variable to change.

Diagnostic information		Remedy instructions	Influenced measured variables	
No.	Short text			
835	Process temperature too low	Increase process temperature	<ul style="list-style-type: none"> ▪ Build-up detection option ▪ Build-up index ▪ Conductivity ▪ Corrected conductivity ▪ Electronics temperature ▪ Empty pipe detection option ▪ Flow velocity ▪ Low flow cut off option ▪ Mass flow ▪ Coil current shot time ▪ Reference electrode potential against PE ▪ Noise ▪ Corrected volume flow ▪ Temperature ▪ Status ▪ Volume flow 	
	Measured variable status [from the factory] ¹⁾			
	Quality			Uncertain
	Quality substatus			Process related
	Coding (hex)			0x78 to 0x7B
	Status signal			S
	Diagnostic behavior			Warning

1) Diagnostic behavior can be changed. This causes the overall status of the measured variable to change.

Diagnostic information		Remedy instructions	Influenced measured variables	
No.	Short text			
842	Process limit	Low flow cut off active! 1. Check low flow cut off configuration	<ul style="list-style-type: none"> ▪ Flow velocity ▪ Mass flow ▪ Corrected volume flow ▪ Status ▪ Volume flow 	
	Measured variable status [from the factory] ¹⁾			
	Quality			Uncertain
	Quality substatus			Process related
	Coding (hex)			0x78 to 0x7B
	Status signal			S
	Diagnostic behavior			Warning

1) Diagnostic behavior can be changed. This causes the overall status of the measured variable to change.

Diagnostic information		Remedy instructions	Influenced measured variables	
No.	Short text			
882	Input signal	1. Check input configuration 2. Check external device or process conditions	<ul style="list-style-type: none"> ▪ Corrected conductivity ▪ Density ▪ Empty pipe detection option ▪ Flow velocity ▪ Low flow cut off option ▪ Mass flow ▪ Coil current shot time ▪ Reference electrode potential against PE ▪ Noise ▪ Corrected volume flow ▪ Temperature ▪ Status ▪ Volume flow 	
	Measured variable status			
	Quality			Bad
	Quality substatus			Maintenance alarm
	Coding (hex)			0x24 to 0x27
	Status signal			F
	Diagnostic behavior			Alarm

Diagnostic information		Remedy instructions	Influenced measured variables	
No.	Short text			
937	Sensor symmetry	1. Eliminate external magnetic field near sensor 2. Turn off diagnostic message	<ul style="list-style-type: none"> ▪ Build-up detection option ▪ Build-up index ▪ Conductivity ▪ Corrected conductivity ▪ Density ▪ Electronics temperature ▪ Empty pipe detection option ▪ Flow velocity ▪ Low flow cut off option ▪ Mass flow ▪ Coil current shot time ▪ Reference electrode potential against PE ▪ Noise ▪ Corrected volume flow ▪ Temperature ▪ Status ▪ Volume flow 	
	Measured variable status [from the factory] ¹⁾			
	Quality			Bad
	Quality substatus			Maintenance alarm
	Coding (hex)			0x24 to 0x27
	Status signal			S
	Diagnostic behavior			Warning

1) Diagnostic behavior can be changed. This causes the overall status of the measured variable to change.

Diagnostic information		Remedy instructions	Influenced measured variables	
No.	Short text			
938	EMC interference	1. Check ambient conditions regarding EMC influence 2. Turn off diagnostic message	<ul style="list-style-type: none"> ▪ Build-up detection option ▪ Build-up index ▪ Conductivity ▪ Corrected conductivity ▪ Density ▪ Electronics temperature ▪ Empty pipe detection option ▪ Flow velocity ▪ Low flow cut off option ▪ Mass flow ▪ Coil current shot time ▪ Reference electrode potential against PE ▪ Noise ▪ Corrected volume flow ▪ Temperature ▪ Status ▪ Volume flow 	
	Measured variable status [from the factory] ¹⁾			
	Quality			Bad
	Quality substatus			Maintenance alarm
	Coding (hex)			0x24 to 0x27
	Status signal			F
	Diagnostic behavior			Alarm

1) Diagnostic behavior can be changed. This causes the overall status of the measured variable to change.

Diagnostic information		Remedy instructions	Influenced measured variables	
No.	Short text			
961	Electrode potential out of specification	1. Check process conditions 2. Check ambient conditions	<ul style="list-style-type: none"> ▪ Empty pipe detection option ▪ Low flow cut off option ▪ Mass flow ▪ Coil current shot time ▪ Reference electrode potential against PE ▪ Noise ▪ Status ▪ Volume flow 	
	Measured variable status [from the factory] ¹⁾			
	Quality			Bad
	Quality substatus			Maintenance alarm
	Coding (hex)			0x24 to 0x27
	Status signal			S
Diagnostic behavior	Warning			

1) Diagnostic behavior can be changed. This causes the overall status of the measured variable to change.





Diagnostic information		Remedy instructions	Influenced measured variables	
No.	Short text			
962	Pipe empty	1. Perform full pipe adjustment 2. Perform empty pipe adjustment 3. Turn off empty pipe detection	<ul style="list-style-type: none"> ▪ Build-up detection option ▪ Build-up index ▪ Conductivity ▪ Corrected conductivity ▪ Flow velocity ▪ Low flow cut off option ▪ Mass flow ▪ Coil current shot time ▪ Reference electrode potential against PE ▪ Noise ▪ Corrected volume flow ▪ Status ▪ Volume flow 	
	Measured variable status [from the factory] ¹⁾			
	Quality			Bad
	Quality substatus			Process related
	Coding (hex)			0x28 to 0x2B
	Status signal			S
Diagnostic behavior	Warning			



1) Diagnostic behavior can be changed. This causes the overall status of the measured variable to change.

12.8 Pending diagnostic events

The **Diagnostics** menu allows the user to view the current diagnostic event and the previous diagnostic event separately.

 To call up the measures to rectify a diagnostic event:



- Via local display →  131
- Via web browser →  132
- Via "FieldCare" operating tool →  133
- Via "DeviceCare" operating tool →  133

 Other pending diagnostic events can be displayed in the **Diagnostic list** submenu →  162

Navigation

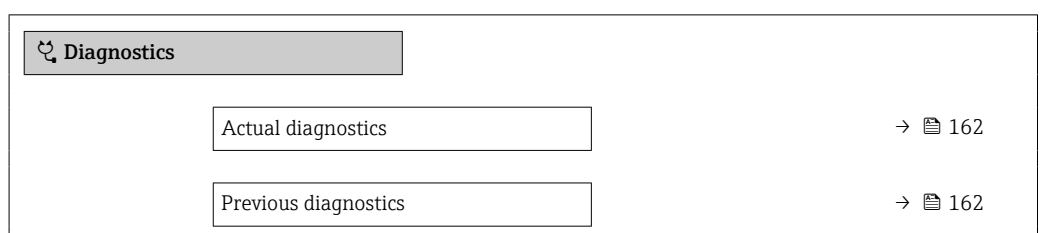
"Diagnostics" menu



Operating time from restart	→  162
Operating time	→  162

Parameter overview with brief description

Parameter	Prerequisite	Description	User interface
Actual diagnostics	A diagnostic event has occurred.	Shows the current occurred diagnostic event along with its diagnostic information.  If two or more messages occur simultaneously, the message with the highest priority is shown on the display.	Symbol for diagnostic behavior, diagnostic code and short message.
Previous diagnostics	Two diagnostic events have already occurred.	Shows the diagnostic event that occurred prior to the current diagnostic event along with its diagnostic information.	Symbol for diagnostic behavior, diagnostic code and short message.
Operating time from restart	–	Shows the time the device has been in operation since the last device restart.	Days (d), hours (h), minutes (m) and seconds (s)
Operating time	–	Indicates how long the device has been in operation.	Days (d), hours (h), minutes (m) and seconds (s)

12.9 Diagnostic list

Up to 5 currently pending diagnostic events can be displayed in the **Diagnostic list** submenu along with the associated diagnostic information. If more than 5 diagnostic events are pending, the events with the highest priority are shown on the display.

Navigation path



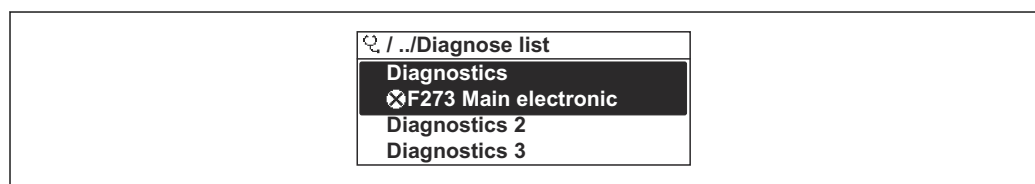

Diagnostics → Diagnostic list



A0014006-EN

 26 Taking the example of the local display

 To call up the measures to rectify a diagnostic event:

- Via local display →  131
- Via web browser →  132
- Via "FieldCare" operating tool →  133
- Via "DeviceCare" operating tool →  133

12.10 Event logbook

12.10.1 Reading out the event logbook

A chronological overview of the event messages that have occurred is provided in the **Events list** submenu.

Navigation path

Diagnostics menu → **Event logbook** submenu → Event list

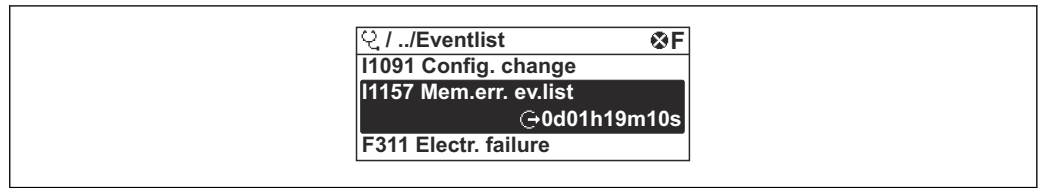

A0014008-EN

27 Taking the example of the local display

- A maximum of 20 event messages can be displayed in chronological order.
- If the **Extended HistoROM** application package (order option) is enabled in the device, the event list can contain up to 100 entries .

The event history includes entries for:

- Diagnostic events → 136
- Information events → 163

In addition to the operation time of its occurrence, each event is also assigned a symbol that indicates whether the event has occurred or is ended:

- Diagnostic event
 - ⌚: Occurrence of the event
 - ⌚: End of the event
- Information event
 - ⌚: Occurrence of the event

i To call up the measures to rectify a diagnostic event:

- Via local display → 131
- Via web browser → 132
- Via "FieldCare" operating tool → 133
- Via "DeviceCare" operating tool → 133

i For filtering the displayed event messages → 163

12.10.2 Filtering the event logbook

Using the **Filter options** parameter you can define which category of event message is displayed in the **Events list** submenu.

Navigation path

Diagnostics → Event logbook → Filter options

Filter categories

- All
- Failure (F)
- Function check (C)
- Out of specification (S)
- Maintenance required (M)
- Information (I)

12.10.3 Overview of information events

Unlike a diagnostic event, an information event is displayed in the event logbook only and not in the diagnostic list.

Info number	Info name
I1000	----- (Device ok)
I1079	Sensor changed

Info number	Info name
I1089	Power on
I1090	Configuration reset
I1091	Configuration changed
I1092	HistoROM backup deleted
I1137	Electronics changed
I1151	History reset
I1155	Reset electronics temperature
I1156	Memory error trend
I1157	Memory error event list
I1256	Display: access status changed
I1335	Firmware changed
I1351	Empty pipe detection adjustment failure
I1353	Empty pipe detection adjustment ok
I1361	Web server: login failed
I1397	Fieldbus: access status changed
I1398	CDI: access status changed
I1443	Build-up thickness not determined
I1444	Device verification passed
I1445	Device verification failed
I1457	Measurement error verification failed
I1459	I/O module verification failed
I1461	Sensor verification failed
I1462	Sensor electronic module verific. failed
I1512	Download started
I1513	Download finished
I1514	Upload started
I1515	Upload finished
I1622	Calibration changed
I1625	Write protection activated
I1626	Write protection deactivated
I1627	Web server: login successful
I1628	Display: login successful
I1629	CDI: login successful
I1631	Web server access changed
I1632	Display: login failed
I1633	CDI: login failed
I1634	Reset to factory settings
I1635	Reset to delivery settings
I1649	Hardware write protection activated
I1650	Hardware write protection deactivated
I1725	Sensor electronic module (ISEM) changed

12.11 Resetting the measuring device

Using the **Device reset** parameter (→  115) it is possible to reset the entire device configuration or some of the configuration to a defined state.

12.11.1 Function scope of the "Device reset" parameter











Options	Description
Cancel	No action is executed and the user exits the parameter.
To delivery settings	Every parameter for which a customer-specific default setting was ordered is reset to this customer-specific value. All other parameters are reset to the factory setting.
Restart device	The restart resets every parameter whose data are in the volatile memory (RAM) to the factory setting (e.g. measured value data). The device configuration remains unchanged.

12.12 Device information





The **Device information** submenu contains all parameters that display different information for device identification.

Navigation

"Diagnostics" menu → Device information



▶ Device information	
Device tag	→  166
Serial number	→  166
Firmware version	→  166
Device name	→  166
Order code	→  166
Extended order code 1	→  166
Extended order code 2	→  166
Extended order code 3	→  166
ENP version	→  166
PROFIBUS ident number	→  166
Status PROFIBUS Master Config	→  166

Parameter overview with brief description

Parameter	Description	User interface	Factory setting
Device tag	Shows name of measuring point.	Max. 32 characters, such as letters, numbers or special characters (e.g. @, %, /).	- none -
Serial number	Shows the serial number of the measuring device.	Max. 11-digit character string comprising letters and numbers.	-
Firmware version	Shows the device firmware version installed.	Character string in the format xx.yy.zz	-
Order code	Shows the device order code.  The order code can be found on the nameplate of the sensor and transmitter in the "Order code" field.	Character string composed of letters, numbers and certain punctuation marks (e.g. /).	-
Device name	Shows the name of the transmitter.  The name can be found on the nameplate of the transmitter.	Max. 32 characters such as letters or numbers.	Promag 400 DP
Extended order code 1	Shows the 1st part of the extended order code.  The extended order code can also be found on the nameplate of the sensor and transmitter in the "Ext. ord. cd." field.	Character string	-
Extended order code 2	Shows the 2nd part of the extended order code.  The extended order code can also be found on the nameplate of the sensor and transmitter in the "Ext. ord. cd." field.	Character string	-
Extended order code 3	Shows the 3rd part of the extended order code.  The extended order code can also be found on the nameplate of the sensor and transmitter in the "Ext. ord. cd." field.	Character string	-
ENP version	Shows the version of the electronic nameplate (ENP).	Character string	2.02.00
PROFIBUS ident number	Displays the PROFIBUS identification number.	0 to FFFF	0x1562
Status PROFIBUS Master Config	Displays the status of the PROFIBUS Master configuration.	<ul style="list-style-type: none"> ■ Active ■ Not active 	Not active

12.13 Firmware history

Release date	Firmware version	Order code for "Firmware version"	Firmware changes	Documentation type	Documentation
02.2022	02.00.zz	Option 67	<ul style="list-style-type: none"> ▪ Web server: Extended function scope ▪ Heartbeat Technology: Extended function scope and extended report ▪ Buildup detection 	Operating Instructions	BA01234D/06/EN/07.21
05.2014	01.00.00	Option 78	Original firmware	Operating Instructions	BA01234D/06/EN/01.14

-  It is possible to flash the firmware to the current version or the previous version using the service interface.
-  For the compatibility of the firmware version with the previous version, the installed device description files and operating tools, observe the information about the device in the "Manufacturer's information" document.
-  The manufacturer's information is available:
 - In the Download Area of the Endress+Hauser web site: www.endress.com → Downloads
 - Specify the following details:
 - Text search: Manufacturer's information
 - Media type: Documentation – Technical Documentation

13 Maintenance

13.1 Maintenance tasks

No special maintenance work is required.

13.1.1 Exterior cleaning

When cleaning the exterior of measuring devices, always use cleaning agents that do not attack the surface of the housing or the seals.

WARNING

Cleaning agents can damage the plastic transmitter housing!

- ▶ Do not use high-pressure steam.
- ▶ Only use the permitted cleaning agents specified.

Permitted cleaning agents for the plastic transmitter housing

- Commercially available household cleaners
- Methyl alcohol or isopropyl alcohol
- Mild soap solutions

13.1.2 Interior cleaning

No interior cleaning is planned for the device.

13.2 Measuring and test equipment

Endress+Hauser offers a wide variety of measuring and test equipment, such as W@M or device tests.

 Your Endress+Hauser Sales Center can provide detailed information on the services.

List of some of the measuring and testing equipment: →  171 →  172

13.3 Endress+Hauser services

Endress+Hauser offers a wide variety of services for maintenance such as recalibration, maintenance service or device tests.

 Your Endress+Hauser Sales Center can provide detailed information on the services.

14 Repair

14.1 General information

14.1.1 Repair and conversion concept

The Endress+Hauser repair and conversion concept provides for the following:

- The measuring devices have a modular design.
- Spare parts are grouped into logical kits with the associated Installation Instructions.
- Repairs are carried out by Endress+Hauser Service or by appropriately trained customers.
- Certified devices can only be converted to other certified devices by Endress+Hauser Service or at the factory.

14.1.2 Notes for repair and conversion



For repair and modification of a measuring device, observe the following notes:

- ▶ Use only original Endress+Hauser spare parts.
- ▶ Carry out the repair according to the Installation Instructions.
- ▶ Observe the applicable standards, federal/national regulations, Ex documentation (XA) and certificates.
- ▶ Document every repair and each conversion and enter them into the *W@M* life cycle management database and Netilion Analytics.

14.2 Spare parts

W@M Device Viewer (www.endress.com/deviceviewer):

All the spare parts for the measuring device, along with the order code, are listed here and can be ordered. If available, users can also download the associated Installation Instructions.

-  Measuring device serial number:
 - Is located on the nameplate of the device.
 - Can be read out via the **Serial number** parameter (→  166) in the **Device information** submenu.

14.3 Endress+Hauser services

Endress+Hauser offers a wide range of services.

-  Your Endress+Hauser Sales Center can provide detailed information on the services.

14.4 Return

The requirements for safe device return can vary depending on the device type and national legislation.

1. Refer to the website for more information:
<http://www.endress.com/support/return-material>
2. Return the device if repairs or a factory calibration are required, or if the wrong device was ordered or delivered.

14.5 Disposal



If required by the Directive 2012/19/EU on waste electrical and electronic equipment (WEEE), the product is marked with the depicted symbol in order to minimize the disposal of WEEE as unsorted municipal waste. Do not dispose of products bearing this marking as unsorted municipal waste. Instead, return them to Endress+Hauser for disposal under the applicable conditions.

14.5.1 Removing the measuring device

1. Switch off the device.

⚠ WARNING

Danger to persons from process conditions!

- ▶ Beware of hazardous process conditions such as pressure in the measuring device, high temperatures or aggressive media.
2. Carry out the mounting and connection steps from the "Mounting the measuring device" and "Connecting the measuring device" sections in reverse order. Observe the safety instructions.

14.5.2 Disposing of the measuring device

⚠ WARNING

Danger to personnel and environment from fluids that are hazardous to health.

- ▶ Ensure that the measuring device and all cavities are free of fluid residues that are hazardous to health or the environment, e.g. substances that have permeated into crevices or diffused through plastic.

Observe the following notes during disposal:



- ▶ Observe valid federal/national regulations.
- ▶ Ensure proper separation and reuse of the device components.

15 Accessories

Various accessories, which can be ordered with the device or subsequently from Endress+Hauser, are available for the device. Detailed information on the order code in question is available from your local Endress+Hauser sales center or on the product page of the Endress+Hauser website: www.endress.com.

15.1 Device-specific accessories

15.1.1 For the transmitter









Accessories	Description
Promag 400 transmitter	Transmitter for replacement or storage. Use the order code to define the following specifications: <ul style="list-style-type: none"> ▪ Approvals ▪ Output/input ▪ Display/operation ▪ Housing ▪ Software  For details, see Installation Instructions EA00104D
Display guard	Is used to protect the display against impact or scoring, for example from sand in desert areas.  Order number: 71228792  Installation Instructions EA01093D
Connecting cable for remote version	Coil current and electrode cables, various lengths, reinforced cables available on request.
Ground cable	Set, consisting of two ground cables for potential equalization.
Post mounting kit	Post mounting kit for transmitter.
Compact → Remote conversion kit	For converting a compact device version to a remote device version.
Conversion kit Promag 50/53 → Promag 400	For converting a Promag with transmitter 50/53 to a Promag 400.

15.1.2 For the sensor



Accessory	Description
Ground disks	Are used to ground the medium in lined measuring tubes to ensure proper measurement.  For details, see Installation Instructions EA00070D

15.2 Communication-specific accessories

Accessories	Description
Commubox FXA291	Connects Endress+Hauser field devices with a CDI interface (= Endress+Hauser Common Data Interface) and the USB port of a computer or laptop.  Technical Information TI405C/07

Fieldgate FXA42	<p>Is used to transmit the measured values of connected 4 to 20 mA analog measuring devices, as well as digital measuring devices</p> <ul style="list-style-type: none">  Technical Information TI01297S  Operating Instructions BA01778S  Product page: www.endress.com/fxa42
Field Xpert SMT70	<p>The Field Xpert SMT70 tablet PC for device configuration enables mobile plant asset management in hazardous and non-hazardous areas. It is suitable for commissioning and maintenance staff to manage field instruments with a digital communication interface and to record progress.</p> <p>This tablet PC is designed as an all-in-one solution with a preinstalled driver library and is an easy-to-use, touch-sensitive tool which can be used to manage field instruments throughout their entire life cycle.</p> <ul style="list-style-type: none">  Technical Information TI01342S  Operating Instructions BA01709S  Product page: www.endress.com/smt70
Field Xpert SMT77	<p>The Field Xpert SMT77 tablet PC for device configuration enables mobile plant asset management in areas categorized as Ex Zone 1.</p> <ul style="list-style-type: none">  Technical Information TI01418S  Operating Instructions BA01923S  Product page: www.endress.com/smt77

15.3 Service-specific accessories

Accessory	Description
Applicator	<p>Software for selecting and sizing Endress+Hauser measuring devices:</p> <ul style="list-style-type: none"> ▪ Choice of measuring devices with industrial requirements ▪ Calculation of all the necessary data for identifying the optimum flowmeter: e.g. nominal diameter, pressure loss, flow velocity and accuracy. ▪ Graphic illustration of the calculation results ▪ Determination of the partial order code, administration, documentation and access to all project-related data and parameters over the entire life cycle of a project. <p>Applicator is available:</p> <ul style="list-style-type: none"> ▪ Via the Internet: https://portal.endress.com/webapp/applicator ▪ As a downloadable DVD for local PC installation.
W@M	<p>W@M Life Cycle Management</p> <p>Improved productivity with information at your fingertips. Data relevant to a plant and its components is generated from the first stages of planning and during the asset's complete life cycle.</p> <p>W@M Life Cycle Management is an open and flexible information platform with online and on-site tools. Instant access for your staff to current, in-depth data shortens your plant's engineering time, speeds up procurement processes and increases plant uptime.</p> <p>Combined with the right services, W@M Life Cycle Management boosts productivity in every phase. For more information, see: www.endress.com/lifecyclemanagement</p>
FieldCare	<p>FDT-based plant asset management tool from Endress+Hauser.</p> <p>It can configure all smart field units in your system and helps you manage them. By using the status information, it is also a simple but effective way of checking their status and condition.</p> <ul style="list-style-type: none">  Operating Instructions BA00027S and BA00059S
DeviceCare	<p>Tool for connecting and configuring Endress+Hauser field devices.</p> <ul style="list-style-type: none">  Innovation brochure IN01047S

15.4 System components

Accessories	Description
Memograph M graphic data manager	<p>The Memograph M graphic data manager provides information on all the relevant measured variables. Measured values are recorded correctly, limit values are monitored and measuring points analyzed. The data are stored in the 256 MB internal memory and also on a SD card or USB stick.</p> <ul style="list-style-type: none"><li data-bbox="770 450 1145 477">■  Technical Information TI00133R<li data-bbox="770 477 1155 504">■ Operating Instructions BA00247R

16 Technical data

16.1 Application

The measuring device is only suitable for the flow measurement of liquids with a minimum conductivity of 5 µS/cm.

Depending on the version ordered, the measuring device can also measure potentially explosive, flammable, poisonous and oxidizing media.

To ensure that the device remains in proper operating condition for its service life, use the measuring device only for media against which the process-wetted materials are sufficiently resistant.

16.2 Function and system design

Measuring principle Electromagnetic flow measurement on the basis of *Faraday's law of magnetic induction*.

Measuring system The device consists of a transmitter and a sensor.
 Two device versions are available:
 ■ Compact version - transmitter and sensor form a mechanical unit.
 ■ Remote version - transmitter and sensor are mounted in separate locations.
 For information on the structure of the device →  13

16.3 Input

Measured variable **Direct measured variables**
 ■ Volume flow (proportional to induced voltage)
 ■ Electrical conductivity
 In custody transfer: only volume flow

Calculated measured variables
 Mass flow

Measuring range Typically $v = 0.01$ to 10 m/s (0.03 to 33 ft/s) with the specified accuracy
 Electrical conductivity: ≥ 5 µS/cm for liquids in general

Flow characteristic values in SI units: DN 25 to 125 mm (1 to 4 in)

Nominal diameter		Recommended flow min./max. full scale value ($v \sim 0.3...10$ m/s) [dm ³ /min]	Factory settings		
[mm]	[in]		Full scale value current output ($v \sim 2.5$ m/s) [dm ³ /min]	Pulse value (~ 2 Pulse/s at $v \sim 2.5$ m/s) [dm ³]	Low flow cut off ($v \sim 0.04$ m/s) [dm ³ /min]
25	1	9 to 300	75	0.5	1
32	-	15 to 500	125	1	2
40	1 ½	25 to 700	200	1.5	3

Nominal diameter		Recommended flow min./max. full scale value (v ~ 0.3...10 m/s) [dm ³ /min]	Factory settings		
[mm]	[in]		Full scale value current output (v ~ 2.5 m/s) [dm ³ /min]	Pulse value (~ 2 Pulse/s at v ~ 2.5 m/s) [dm ³]	Low flow cut off (v ~ 0.04 m/s) [dm ³ /min]
50	2	35 to 1 100	300	2.5	5
65	-	60 to 2 000	500	5	8
80	3	90 to 3 000	750	5	12
100	4	145 to 4 700	1 200	10	20
125	-	220 to 7 500	1 850	15	30

Flow characteristic values in SI units: DN 150 to 3 000 mm (6 to 120 in)

Nominal diameter		Recommended flow min./max. full scale value (v ~ 0.3...10 m/s) [m ³ /h]	Factory settings		
[mm]	[in]		Full scale value current output (v ~ 2.5 m/s) [m ³ /h]	Pulse value (~ 2 Pulse/s at v ~ 2.5 m/s) [m ³]	Low flow cut off (v ~ 0.04 m/s) [m ³ /h]
150	6	20 to 600	150	0.025	2.5
200	8	35 to 1 100	300	0.05	5
250	10	55 to 1 700	500	0.05	7.5
300	12	80 to 2 400	750	0.1	10
350	14	110 to 3 300	1 000	0.1	15
375	15	140 to 4 200	1 200	0.15	20
400	16	140 to 4 200	1 200	0.15	20
450	18	180 to 5 400	1 500	0.25	25
500	20	220 to 6 600	2 000	0.25	30
600	24	310 to 9 600	2 500	0.3	40
700	28	420 to 13 500	3 500	0.5	50
750	30	480 to 15 000	4 000	0.5	60
800	32	550 to 18 000	4 500	0.75	75
900	36	690 to 22 500	6 000	0.75	100
1000	40	850 to 28 000	7 000	1	125
-	42	950 to 30 000	8 000	1	125
1200	48	1 250 to 40 000	10 000	1.5	150
-	54	1 550 to 50 000	13 000	1.5	200
1400	-	1 700 to 55 000	14 000	2	225
-	60	1 950 to 60 000	16 000	2	250
1600	-	2 200 to 70 000	18 000	2.5	300
-	66	2 500 to 80 000	20 500	2.5	325
1800	72	2 800 to 90 000	23 000	3	350
-	78	3 300 to 100 000	28 500	3.5	450
2000	-	3 400 to 110 000	28 500	3.5	450
-	84	3 700 to 125 000	31 000	4.5	500

Nominal diameter		Recommended flow min./max. full scale value (v ~ 0.3...10 m/s)	Factory settings		
[mm]	[in]		Full scale value current output (v ~ 2.5 m/s)	Pulse value (~ 2 Pulse/s at v ~ 2.5 m/s)	Low flow cut off (v ~ 0.04 m/s)
		[m ³ /h]	[m ³ /h]	[m ³]	[m ³ /h]
2200	-	4 100 to 136 000	34 000	4.5	540
-	90	4 300 to 143 000	36 000	5	570
2400	-	4 800 to 162 000	40 000	5.5	650
-	96	5 000 to 168 000	42 000	6	675
-	102	5 700 to 190 000	47 500	7	750
2600	-	5 700 to 191 000	48 000	7	775
-	108	6 500 to 210 000	55 000	7	850
2800	-	6 700 to 222 000	55 500	8	875
-	114	7 100 to 237 000	59 500	8	950
3000	-	7 600 to 254 000	63 500	9	1025
-	120	7 900 to 263 000	65 500	9	1050

Flow characteristic values in SI units: DN 50 to 200 mm (2 to 8 in) for order code for "Design", option C "Fixed flange, constricted measuring tube, 0 x DN inlet/outlet runs"

Nominal diameter		Recommended flow min./max. full scale value (v ~ 0.12...5 m/s)	Factory settings		
[mm]	[in]		Full scale value current output (v ~ 2.5 m/s)	Pulse value (~ 4 Pulse/s at v ~ 2.5 m/s)	Low flow cut off (v ~ 0.01 m/s)
		[dm ³ /min]	[dm ³ /min]	[dm ³]	[dm ³ /min]
50	2	15 to 600	300	1.25	1.25
65	-	25 to 1 000	500	2	2
80	3	35 to 1 500	750	3	3.25
100	4	60 to 2 400	1 200	5	4.75
125	-	90 to 3 700	1 850	8	7.5
150	6	145 to 5 400	2 500	10	11
200	8	220 to 9 400	5 000	20	19

Flow characteristic values in SI units: DN 250 to 300 mm (10 to 12 in) for order code for "Design", option C "Fixed flange, constricted measuring tube, 0 x DN inlet/outlet runs"

Nominal diameter		Recommended flow min./max. full scale value (v ~ 0.12...5 m/s)	Factory settings		
[mm]	[in]		Full scale value current output (v ~ 2.5 m/s)	Pulse value (~ 4 Pulse/s at v ~ 2.5 m/s)	Low flow cut off (v ~ 0.01 m/s)
		[m ³ /h]	[m ³ /h]	[m ³]	[m ³ /h]
250	10	20 to 850	500	0.03	1.75
300	12	35 to 1 300	750	0.05	2.75

Flow characteristic values in US units: DN 1 to 48 in (25 to 1200 mm)

Nominal diameter		Recommended flow min./max. full scale value (v ~ 0.3...10 m/s) [gal/min]	Factory settings		
[in]	[mm]		Full scale value current output (v ~ 2.5 m/s) [gal/min]	Pulse value (~ 2 Pulse/s at v ~ 2.5 m/s) [gal]	Low flow cut off (v ~ 0.04 m/s) [gal/min]
1	25	2.5 to 80	18	0.2	0.25
-	32	4 to 130	30	0.2	0.5
1 ½	40	7 to 185	50	0.5	0.75
2	50	10 to 300	75	0.5	1.25
-	65	16 to 500	130	1	2
3	80	24 to 800	200	2	2.5
4	100	40 to 1250	300	2	4
-	125	60 to 1950	450	5	7
6	150	90 to 2650	600	5	12
8	200	155 to 4850	1200	10	15
10	250	250 to 7500	1500	15	30
12	300	350 to 10600	2400	25	45
14	350	500 to 15000	3600	30	60
15	375	600 to 19000	4800	50	60
16	400	600 to 19000	4800	50	60
18	450	800 to 24000	6000	50	90
20	500	1000 to 30000	7500	75	120
24	600	1400 to 44000	10500	100	180
28	700	1900 to 60000	13500	125	210
30	750	2150 to 67000	16500	150	270
32	800	2450 to 80000	19500	200	300
36	900	3100 to 100000	24000	225	360
40	1000	3800 to 125000	30000	250	480
42	-	4200 to 135000	33000	250	600
48	1200	5500 to 175000	42000	400	600

Flow characteristic values in US units: DN 54 to 120 in (1400 to 3000 mm)



Nominal diameter		Recommended flow min./max. full scale value (v ~ 0.3...10 m/s) [Mgal/d]	Factory settings		
[in]	[mm]		Full scale value current output (v ~ 2.5 m/s) [Mgal/d]	Pulse value (~ 2 Pulse/s at v ~ 2.5 m/s) [Mgal]	Low flow cut off (v ~ 0.04 m/s) [Mgal/d]
54	-	9 to 300	75	0.0005	1.3
-	1400	10 to 340	85	0.0005	1.3
60	-	12 to 380	95	0.0005	1.3
-	1600	13 to 450	110	0.0008	1.7
66	-	14 to 500	120	0.0008	2.2
72	1800	16 to 570	140	0.0008	2.6

Nominal diameter		Recommended flow min./max. full scale value (v ~ 0.3...10 m/s) [Mgal/d]	Factory settings		
[in]	[mm]		Full scale value current output (v ~ 2.5 m/s) [Mgal/d]	Pulse value (~ 2 Pulse/s at v ~ 2.5 m/s) [Mgal]	Low flow cut off (v ~ 0.04 m/s) [Mgal/d]
78	-	18 to 650	175	0.0010	3.0
-	2000	20 to 700	175	0.0010	2.9
84	-	24 to 800	190	0.0011	3.2
-	2200	26 to 870	210	0.0012	3.4
90	-	27 to 910	220	0.0013	3.6
-	2400	31 to 1030	245	0.0014	4.0
96	-	32 to 1066	265	0.0015	4.0
102	-	34 to 1203	300	0.0017	5.0
-	2600	34 to 1212	305	0.0018	5.0
108	-	35 to 1300	340	0.0020	5.0
-	2800	42 to 1405	350	0.0020	6.0
114	-	45 to 1503	375	0.0022	6.0
-	3000	48 to 1613	405	0.0023	6.0
120	-	50 to 1665	415	0.0024	7.0

Flow characteristic values in US units: DN 2 to 12 in (50 to 300 mm) for order code for "Design", option C "Fixed flange, constricted measuring tube, 0 x DN inlet/outlet runs"

Nominal diameter		Recommended flow min./max. full scale value (v ~ 0.12...5 m/s) [gal/min]	Factory settings		
[in]	[mm]		Full scale value current output (v ~ 2.5 m/s) [gal/min]	Pulse value (~ 4 Pulse/s at v ~ 2.5 m/s) [gal]	Low flow cut off (v ~ 0.01 m/s) [gal/min]
2	50	4 to 160	75	0.3	0.35
-	65	7 to 260	130	0.5	0.6
3	80	10 to 400	200	0.8	0.8
4	100	16 to 650	300	1.2	1.25
-	125	24 to 1000	450	1.8	2
6	150	40 to 1400	600	2.5	3
8	200	60 to 2500	1200	5	5
10	250	90 to 3700	1500	6	8
12	300	155 to 5700	2400	9	12

Recommended measuring range



 Flow limit →  188

 For custody transfer, the applicable approval determines the permitted measuring range, the pulse value and the low flow cut off.

Operable flow range Over 1000 : 1

 For custody transfer, the operable flow range is 100 : 1 to 630 : 1, depending on the nominal diameter. Further details are specified by the applicable approval.

Input signal **External measured values**

 Various pressure transmitters and temperature measuring devices can be ordered from Endress+Hauser: see "Accessories" section →  173

It is recommended to read in external measured values to calculate the following measured variables:
Mass flow

Digital communication

The measured values are written from the automation system to the measuring device via PROFIBUS DP.

Status input

Maximum input values	<ul style="list-style-type: none"> ▪ DC 30 V ▪ 6 mA
Response time	Configurable: 5 to 200 ms
Input signal level	<ul style="list-style-type: none"> ▪ Low signal (low): DC -3 to +5 V ▪ High signal (high): DC 12 to 30 V
Assignable functions	<ul style="list-style-type: none"> ▪ Off ▪ Reset totalizers 1-3 separately ▪ Reset all totalizers ▪ Flow override

16.4 Output

Output signal **PROFIBUS DP**

Signal encoding	NRZ code
Data transmission	9.6 kBaud...12 MBaud

Signal on alarm Depending on the interface, failure information is displayed as follows:

PROFIBUS DP

Status and alarm messages	Diagnostics in accordance with PROFIBUS PA Profile 3.02
---------------------------	---

Local display

Plain text display	With information on cause and remedial measures
Backlight	Red backlighting indicates a device error.

 Status signal as per NAMUR recommendation NE 107

Interface/protocol



- Via digital communication:
PROFIBUS DP
- Via service interface
 - CDI-RJ45 service interface
 - WLAN interface

Plain text display	With information on cause and remedial measures
---------------------------	---

Web browser

Plain text display	With information on cause and remedial measures
---------------------------	---

Light emitting diodes (LED)

Status information	Status indicated by various light emitting diodes The following information is displayed depending on the device version: <ul style="list-style-type: none"> ■ Supply voltage active ■ Data transmission active ■ Device alarm/error has occurred  Diagnostic information via light emitting diodes →  127
---------------------------	--

Low flow cut off The switch points for low flow cut off are user-selectable.

Galvanic isolation The following connections are galvanically isolated from each other:

- Outputs
- Power supply

Protocol-specific data

PROFIBUS DP

Manufacturer ID	0x11
Ident number	0x1562
Profile version	3.02
Device description files (GSD, DTM, DD)	Information and files under: <ul style="list-style-type: none"> ■ www.endress.com ■ www.profibus.org
Output values	Output values (from the measuring device to the automation system) <ul style="list-style-type: none"> ■ 4 Analog input ■ 2 Digital input ■ 3 Totalizer
Input values	Input values (from the automation system to the measuring device) <ul style="list-style-type: none"> ■ 2 Analog output (fixed assignment) ■ 2 Digital output (fixed assignment) ■ 3 Totalizer
Device address configuration options	Configuration of the device address <ul style="list-style-type: none"> ■ Hardware: DIP switches on the I/O electronics module ■ Software: Via operating tools (e.g. FieldCare)

Supported functions	<ul style="list-style-type: none"> ▪ Identification & Maintenance: Simplest device identification on the part of the control system and nameplate ▪ PROFIBUS upload/download: Reading and writing parameters is up to ten times faster with PROFIBUS upload/download ▪ Condensed status: Simplest and self-explanatory diagnostic information by categorizing diagnostic messages that occur
System integration	→  86

16.5 Power supply

Terminal assignment →  43

Supply voltage **Transmitter**

Order code for "Power supply"	terminal voltage		Frequency range
Option L	DC 24 V	±25%	–
	AC 24 V	±25%	50/60 Hz, ±4 Hz
	AC 100 to 240 V	–15 to +10%	50/60 Hz, ±4 Hz

Power consumption

Order code for "Output"	Maximum power consumption
Option L: PROFIBUS DP	30 VA/8 W

Current consumption **Transmitter**

Order code for "Power supply"	Maximum Current consumption	Maximum switch-on current
Option L: AC 100 to 240 V	145 mA	25 A (< 5 ms)
Option L: AC/DC 24 V	350 mA	27 A (< 5 ms)

Power supply failure

- Totalizers stop at the last value measured.
- Depending on the device version, the configuration is retained in the device memory or in the pluggable data memory (HistoROM DAT).
- Error messages (incl. total operated hours) are stored.

Electrical connection →  47

Potential equalization →  52

Terminals

Transmitter

- Supply voltage cable: plug-in spring terminals for wire cross-sections 0.5 to 2.5 mm² (20 to 14 AWG)
- Signal cable: plug-in spring terminals for wire cross-sections 0.5 to 2.5 mm² (20 to 14 AWG)
- Electrode cable: spring terminals for wire cross-sections 0.5 to 2.5 mm² (20 to 14 AWG)
- Coil current cable: spring terminals for wire cross-sections 0.5 to 2.5 mm² (20 to 14 AWG)

Sensor connection housing

Spring terminals for wire cross-sections 0.5 to 2.5 mm² (20 to 14 AWG)

Cable entries

Cable entry thread

- M20 x 1.5
- Via adapter:
 - NPT 1/2"
 - G 1/2"

Cable gland

- For standard cable: M20 x 1.5 with cable ϕ 6 to 12 mm (0.24 to 0.47 in)
- For armored cable: M20 x 1.5 with cable ϕ 9.5 to 16 mm (0.37 to 0.63 in)

 If metal cable entries are used, use a grounding plate.

Cable specification

→  41

16.6 Performance characteristics

Reference operating conditions

- Error limits following DIN EN 29104, in future ISO 20456
- Water, typically +15 to +45 °C (+59 to +113 °F); 0.5 to 7 bar (73 to 101 psi)
- Data as indicated in the calibration protocol
- Accuracy based on accredited calibration rigs according to ISO 17025

Maximum measured error

Error limits under reference operating conditions

Volume flow

- $\pm 0.5\%$ o.r. ± 1 mm/s (0.04 in/s)
- Optional: $\pm 0.2\%$ o.r. ± 2 mm/s (0.08 in/s)

 Fluctuations in the supply voltage do not have any effect within the specified range.

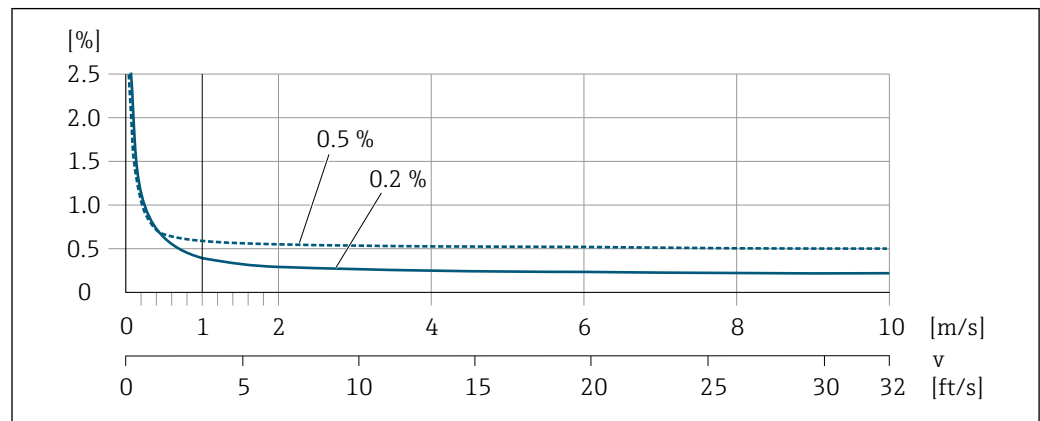

 28 Maximum measured error in % o.r.

Flat Spec

For Flat Spec in the range $v_{0.5}$ ($v_{0.2}$) up to v_{max} the measured error is constant.

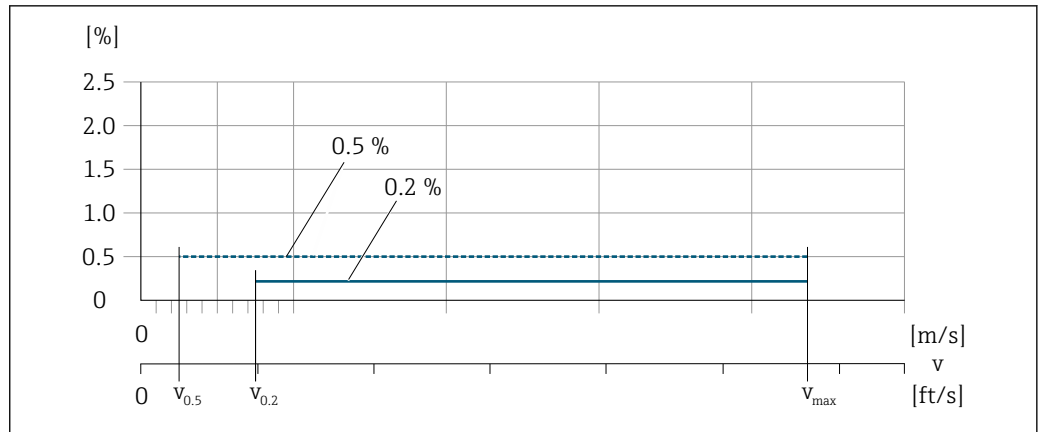

29 Flat Spec in % o.r.

Flat Spec flow values 0.5 %

Nominal diameter		v _{0.5}		v _{max}	
[mm]	[in]	[m/s]	[ft/s]	[m/s]	[ft/s]
25 to 600	1 to 24	0.5	1.64	10	32
50 to 300 ¹⁾	2 to 12	0.25	0.82	5	16

1) Order code for "Design", option C

Flat Spec flow values 0.2 %

Nominal diameter		v _{0.2}		v _{max}	
[mm]	[in]	[m/s]	[ft/s]	[m/s]	[ft/s]
25 to 600	1 to 24	1.5	4.92	10	32
50 to 300 ¹⁾	2 to 12	0.6	1.97	4	13

1) Order code for "Design", option C

Electrical conductivity

The values apply for:

- Measurements at a reference temperature of 25 °C (77 °F)
At different temperatures, attention must be paid to the temperature coefficient of the medium (typically 2.1 %/K)
- Device version: compact version - transmitter and sensor form a mechanical unit
- Devices installed in a metal pipe or in a non-metal pipe with ground disks
- Devices whose potential equalization was performed according to the instructions in the associated Operating Instructions

Conductivity [µS/cm]	Measured error [%] o. r.
5 to 20	± 20%
20 to 20000	± 10%
20000 to 100000	± 20%

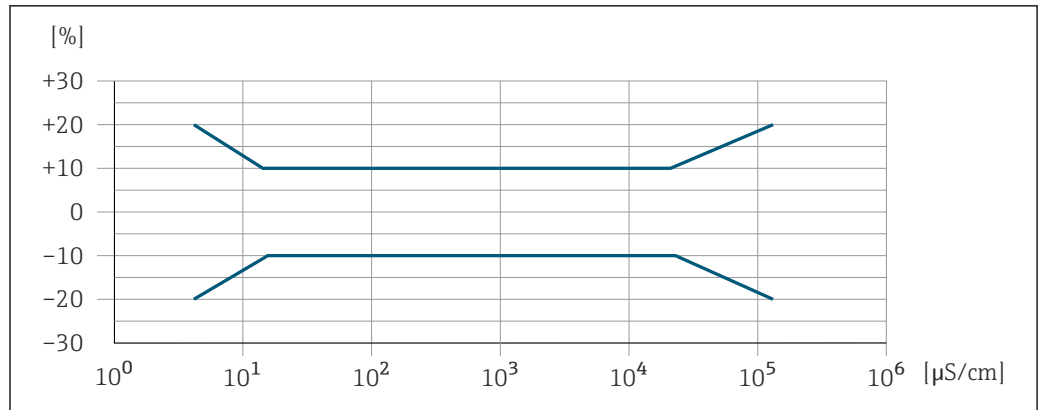

30 Measured error

A0042279

Accuracy of outputs

The outputs have the following base accuracy specifications.

Repeatability

o.r. = of reading

Volume flow

max. ±0.1 % o.r. ± 0.5 mm/s (0.02 in/s)

Electrical conductivity

Max. ±5 % o.r.

Influence of ambient temperature

Current output

o.r. = of reading

Temperature coefficient	Max. ±0.005 % o.r./°C
-------------------------	-----------------------

Pulse/frequency output

Temperature coefficient	No additional effect. Included in accuracy.
-------------------------	---

16.7 Installation

Installation conditions

→ 19

16.8 Environment

Ambient temperature range

→ 25

Storage temperature

The storage temperature corresponds to the operating temperature range of the transmitter and the sensor → 25.

- Protect the measuring device against direct sunlight during storage in order to avoid unacceptably high surface temperatures.
- Select a storage location where moisture cannot collect in the measuring device as fungus or bacteria infestation can damage the liner.
- If protection caps or protective covers are mounted these should never be removed before installing the measuring device.

Atmosphere

If a plastic transmitter housing is permanently exposed to certain steam and air mixtures, this can damage the housing.



In cases of doubt, please contact the Sales Center.

Degree of protection
Transmitter

- IP66/67, type 4X enclosure
- When housing is open: IP20, type 1 enclosure
- Display module: IP20, type 1 enclosure

Sensor

Compact and remote version

IP66/67, type 4X enclosure

Optionally available for compact and remote version:

Order code for "Sensor option", option CA, C3

- IP66/67, type 4X enclosure
- Fully welded, with protective coating as per EN ISO 12944 C5-M
- For the operation of the device in corrosive environments

Optionally available for remote version:

Order code for "Sensor option", option CB, CC

- IP68, type 6P enclosure
- Fully welded, with protective coating as per EN ISO 12944 C5-M/Im1 and EN 60529
- For the operation of the device under water
- Operating duration at a maximum depth of:
 - 3 m (10 ft): permanent use
 - 10 m (30 ft): maximum 48 hours

Order code for "Sensor option", option CQ

- IP68, type 6P, temporarily waterproof
- Sensor with aluminum half-shell housing
- For the temporary operation of the device under non-corrosive water
- Operating duration at a maximum depth of:
 - 3 m (10 ft): maximum 168 hours

Order code for "Sensor option", option CD, CE

- IP68, type 6P enclosure
- Fully welded, with protective coating as per EN ISO 12944 Im2/Im3 and EN 60529
- For the operation of the device in buried applications
- For the operation of the device under water and in saline water
- Operating duration at a maximum depth of:
 - 3 m (10 ft): permanent use
 - 10 m (30 ft): maximum 48 hours

Vibration- and shock-resistance

Sinusoidal vibration according to IEC 60068-2-6

Compact version; order code for "Housing", option A "Compact, aluminum, coated"

- 2 to 8.4 Hz, 3.5 mm peak
- 8.4 to 2 000 Hz, 1 g peak

Compact version; order code for "Housing", option M "Compact, polycarbonate"

- 2 to 8.4 Hz, 7.5 mm peak
- 8.4 to 2 000 Hz, 2 g peak

Remote version; order code for "Housing", option N "Remote, polycarbonate" and option P "Remote, aluminum, coated"

- 2 to 8.4 Hz, 7.5 mm peak
- 8.4 to 2 000 Hz, 2 g peak

Vibration broad-band random, according to IEC 60068-2-64

Compact version; order code for "Housing", option A "Compact, aluminum, coated"

- 10 to 200 Hz, 0.003 g²/Hz
- 200 to 2 000 Hz, 0.001 g²/Hz
- Total: 1.54 g rms

Compact version; order code for "Housing", option M "Compact, polycarbonate"

- 10 to 200 Hz, 0.01 g²/Hz
- 200 to 2 000 Hz, 0.003 g²/Hz
- Total: 2.70 g rms

Remote version; order code for "Housing", option N "Remote, polycarbonate" and option P "Remote, aluminum, coated"

- 10 to 200 Hz, 0.01 g²/Hz
- 200 to 2 000 Hz, 0.003 g²/Hz
- Total: 2.70 g rms

Shock half-sine, according to IEC 60068-2-27

- Compact version; order code for "Housing", option A "Compact, aluminum, coated"
6 ms 30 g
- Compact version; order code for "Housing", option M "Compact, polycarbonate"
6 ms 50 g
- Remote version; order code for "Housing", option N "Remote, polycarbonate" and option P "Remote, aluminum, coated"
6 ms 50 g

Rough handling shocks according to IEC 60068-2-31

Mechanical load

- Protect the transmitter housing against mechanical effects, such as shock or impact; the use of the remote version is sometimes preferable.
- Never use the transmitter housing as a ladder or climbing aid.

Electromagnetic compatibility (EMC)

- As per IEC/EN 61326 and NAMUR Recommendation 21 (NE 21)
- Complies with emission limits for industry as per EN 55011 (Class A)
- Device version with PROFIBUS DP: Complies with emission limits for industry as per EN 50170 Volume 2, IEC 61784

 The following applies for PROFIBUS DP: If baud rates > 1.5 MBaud, an EMC cable entry must be used and the cable shield must continue as far as the terminal wherever possible.

 Details are provided in the Declaration of Conformity.

16.9 Process

- Medium temperature range
- 0 to +80 °C (+32 to +176 °F) for hard rubber, DN 50 to 3000 (2 to 120")
 - -20 to +50 °C (-4 to +122 °F) for polyurethane, DN 25 to 1200 (1 to 48")
 - -20 to +90 °C (-4 to +194 °F) for PTFE, DN 25 to 300 (1 to 12")

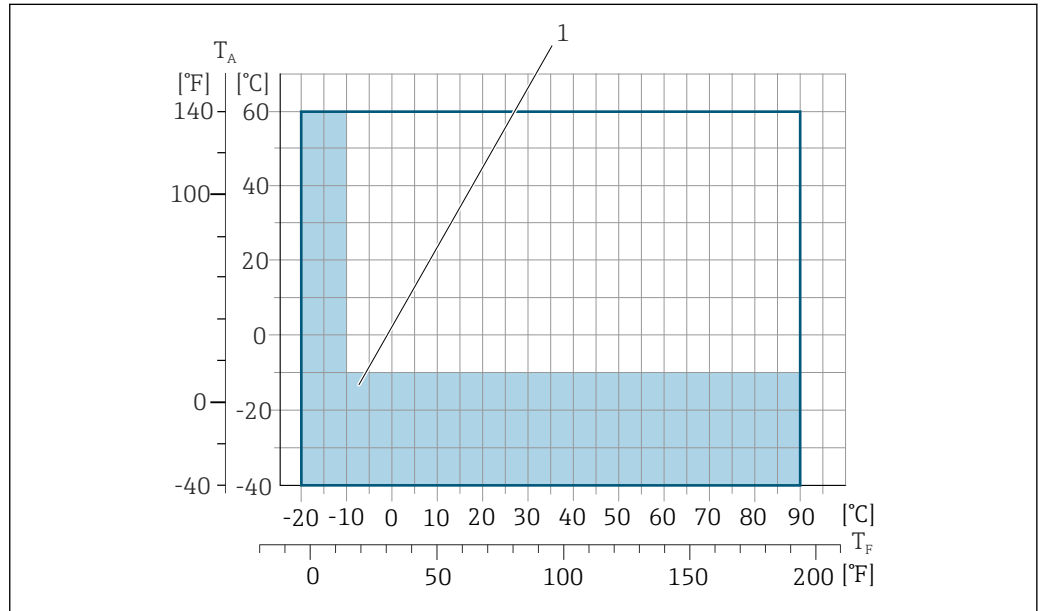

T_A Ambient temperature

T_F Medium temperature

1 Colored area: The ambient temperature range of -10 to -40 °C (+14 to -40 °F) and the medium temperature range of -10 to -20 °C (+14 to -4 °F) only apply for stainless flanges

i The permitted fluid temperature in custody transfer is 0 to +50 °C (+32 to +122 °F).

Conductivity $\geq 5 \mu\text{S}/\text{cm}$ for liquids in general.

- i** Note that in the case of the remote version, the requisite minimum conductivity additionally depends on the length of the connecting cable → 26.
- Maximum measured error for electrical conductivity → 183.

Pressure-temperature ratings **i** For an overview of the pressure-temperature ratings for the process connections, see the Technical Information → 204

Pressure tightness *Liner: hard rubber*

Nominal diameter		Limit values for absolute pressure in [mbar] ([psi]) for medium temperatures:		
[mm]	[in]	+25 °C (+77 °F)	+50 °C (+122 °F)	+80 °C (+176 °F)
50 ... 3000	2 ... 120	0 (0)	0 (0)	0 (0)

Liner: polyurethane

Nominal diameter		Limit values for absolute pressure in [mbar] ([psi]) for medium temperatures:	
[mm]	[in]	+25 °C (+77 °F)	+50 °C (+122 °F)
25 ... 1200	1 ... 48	0 (0)	0 (0)

Liner: PTFE

Nominal diameter		Limit values for absolute pressure in [mbar] ([psi]) for medium temperatures:	
[mm]	[in]	+25 °C (+77 °F)	+90 °C (+194 °F)
25	1	0 (0)	0 (0)
40	2	0 (0)	0 (0)
50	2	0 (0)	0 (0)
65	2 ½	0 (0)	40 (0.58)
80	3	0 (0)	40 (0.58)
100	4	0 (0)	135 (2.0)
125	5	135 (2.0)	240 (3.5)
150	6	135 (2.0)	240 (3.5)
200	8	200 (2.9)	290 (4.2)
250	10	330 (4.8)	400 (5.8)
300	12	400 (5.8)	500 (7.3)

Flow limit

The diameter of the pipe and the flow rate determine the nominal diameter of the sensor. The optimum velocity of flow is between 2 to 3 m/s (6.56 to 9.84 ft/s). Also match the velocity of flow (v) to the physical properties of the medium:

- v < 2 m/s (6.56 ft/s): for abrasive media (e.g. potter's clay, lime milk, ore slurry)
- v > 2 m/s (6.56 ft/s): for media producing buildup (e.g. wastewater sludge)

 A necessary increase in the flow velocity can be achieved by reducing the sensor nominal diameter.

 For an overview of the full scale values for the measuring range, see the "Measuring range" section →  174

 For custody transfer, the applicable approval determines the permitted measuring range.

Pressure loss

- No pressure loss occurs if the sensor is installed in a pipe with the same nominal diameter.
- Pressure losses for configurations incorporating adapters according to DIN EN 545 →  26

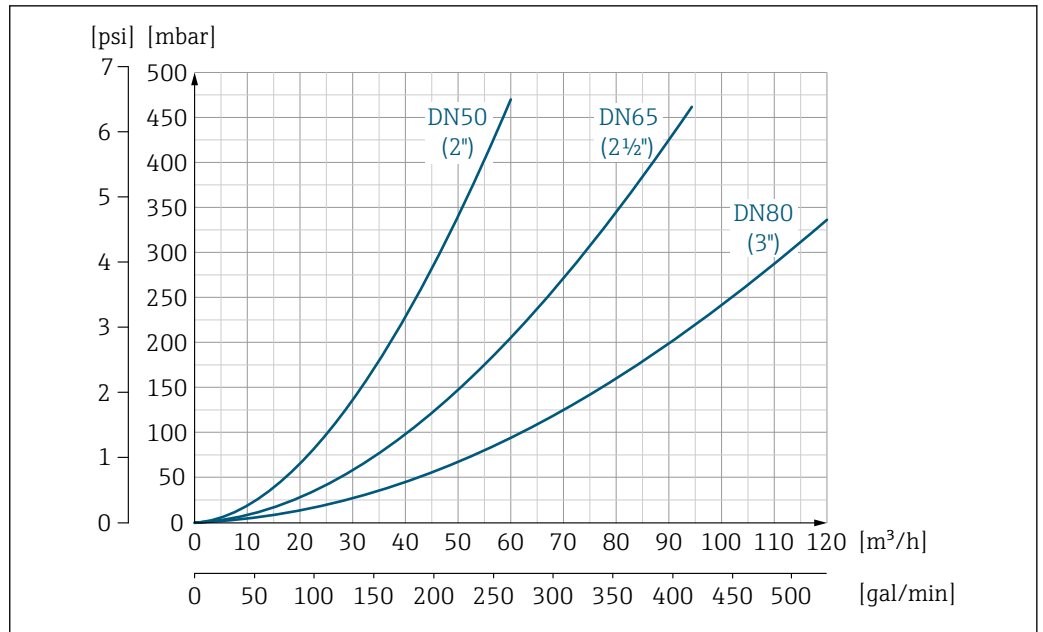

31 Pressure loss DN 50 to 80 (2 to 3") for order code for "Design", option C "Fixed flange, constricted measuring tube", 0 x DN inlet/outlet runs"

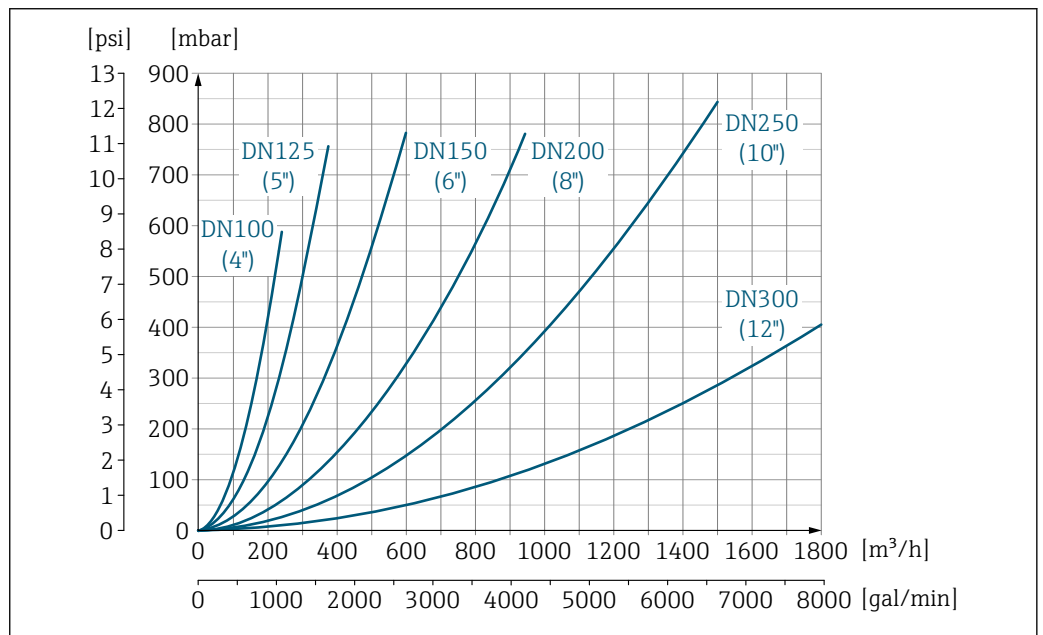

32 Pressure loss DN 100 to 300 (4 to 12") for order code for "Design", option C "Fixed flange, constricted measuring tube", 0 x DN inlet/outlet runs"

System pressure

Installation near pumps → 20

Vibrations

Installation in event of pipe vibrations → 21

16.10 Mechanical construction

Design, dimensions

For the dimensions and installed lengths of the device, see the "Technical Information" document, "Mechanical construction" section → 204

Weight

All values (weight exclusive of packaging material) refer to devices with flanges of the standard pressure rating.
The weight may be lower than indicated depending on the pressure rating and design.

Weight in SI units

Order code for "Design", option C, D, E, H, I : DN 25 to 400 mm (1 to 16 in)			
Nominal diameter		Reference values EN (DIN), AS, JIS	
[mm]	[in]	Pressure rating	[kg]
25	1	PN 40	10
32	-	PN 40	11
40	1 ½	PN 40	12
50	2	PN 40	13
65	-	PN 16	13
80	3	PN 16	15
100	4	PN 16	18
125	-	PN 16	25
150	6	PN 16	31
200	8	PN 10	52
250	10	PN 10	81
300	12	PN 10	95
350	14	PN 6	106
375	15	PN 6	121
400	16	PN 6	121

Order code for "Design", option F, J: DN 450 to 2000 mm (18 to 78 in)			
Nominal diameter		Reference values	
[mm]	[in]	EN (DIN) (PN16) [kg]	AS (PN 16) [kg]
450	18	142	138
500	20	182	186
600	24	227	266
700	28	291	369
-	30	-	447
800	32	353	524
900	36	444	704
1000	40	566	785
-	42	-	-
1200	48	843	1229
-	54	-	-
1400	-	1204	-
-	60	-	-
1600	-	1845	-
-	66	-	-

Order code for "Design", option F, J: DN 450 to 2 000 mm (18 to 78 in)			
Nominal diameter		Reference values	
		EN (DIN) (PN16)	AS (PN 16)
[mm]	[in]	[kg]	[kg]
1800	72	2 357	-
-	78	2 929	-
2000	-	2 929	-

Order code for "Design", option F, J: DN 2 200 to 3 000 mm (84 to 120 in)		
Nominal diameter		Reference values
		EN (DIN) (PN6)
[mm]	[in]	[kg]
-	84	-
2200	-	3 422
-	90	-
2400	-	4 094
-	96	-
-	102	-
2600	-	7 601.5
-	108	-
2800	-	9 466.5
-	114	-
3000	-	11 911
-	120	-

Order code for "Design", option G, K: DN 450 to 2 000 mm (18 to 78 in)		
Nominal diameter		Reference values
		EN (DIN) (PN 6)
[mm]	[in]	[kg]
450	18	161
500	20	156
600	24	208
700	28	304
-	30	-
800	32	357
900	36	485
1000	40	589
-	42	-
1200	48	850
-	54	850
1400	-	1 300
-	60	-
1600	-	1 845

Order code for "Design", option G, K: DN 450 to 2 000 mm (18 to 78 in)		
Nominal diameter		Reference values
[mm]	[in]	EN (DIN) (PN 6) [kg]
-	66	-
1800	72	2 357
-	78	2 929
2000	-	2 929

Weight in US units

Order code for "Design", option C, D, E, H, I: DN 1 to 16 in (25 to 400 mm)		
Nominal diameter		Reference values
[mm]	[in]	ASME (Class 150) [lb]
25	1	11
32	-	-
40	1 ½	15
50	2	20
65	-	-
80	3	31
100	4	42
125	-	-
150	6	73
200	8	115
250	10	198
300	12	284
350	14	379
375	15	-
400	16	448

Order code for "Design", option F, J: DN 18 to 120 in (450 to 3 000 mm)		
Nominal diameter		Reference values
[mm]	[in]	ASME (Class 150), AWWA (Class D) [lb]
450	18	421
500	20	503
600	24	666
700	28	587
-	30	701
800	32	845
900	36	1 036
1000	40	1 294
-	42	1 477
1200	48	1 987

Order code for "Design", option F, J: DN 18 to 120 in (450 to 3 000 mm)		
Nominal diameter		Reference values ASME (Class 150), AWWA (Class D)
[mm]	[in]	[lb]
-	54	2 807
1400	-	-
-	60	3 515
1600	-	-
-	66	4 699
1800	72	5 662
-	78	6 864
2000	-	6 864
-	84	8 280
2200	-	-
-	90	10 577
2400	-	-
-	96	15 574.6
-	102	18 023.9
2600	-	-
-	108	20 783.0
2800	-	-
-	114	24 060.2
3000	-	-
-	120	27 724.3

Order code for "Design", option G, K: DN 18 to 78 in (450 to 2 000 mm)		
Nominal diameter		Reference values ASME (Class 150), AWWA (Class D)
[mm]	[in]	[lb]
450	18	562
500	20	628
600	24	893
700	28	882
-	30	1 014
800	32	1 213
900	36	1 764
1000	40	1 984
-	42	2 426
1200	48	3 087
-	54	4 851
1400	-	-
-	60	5 954
1600	-	-
-	66	8 158

Order code for "Design", option G, K: DN 18 to 78 in (450 to 2000 mm)		
Nominal diameter		Reference values ASME (Class 150), AWWA (Class D)
[mm]	[in]	[lb]
1800	72	9040
-	78	10 143
2000	-	-

Measuring tube specification



The values are reference values and can vary depending on the pressure rating, design and order option.

Nominal diameter		Pressure rating				Measuring tube internal diameter					
		EN (DIN)	ASME AWWA	AS 2129 AS 4087	JIS	Hard rubber		Polyurethane		PTFE	
[mm]	[in]					[mm]	[in]	[mm]	[in]	[mm]	[in]
25	1	PN 40	Class 150	-	20K	-	-	24	0.93	25	1.00
32	-	PN 40	-	-	20K	-	-	32	1.28	34	1.34
40	1 ½	PN 40	Class 150	-	20K	-	-	38	1.51	40	1.57
50	2	PN 40	Class 150	Table E, PN 16	10K	50	1.98	50	1.98	52	2.04
50 ¹⁾	2	PN 40	Class 150	Table E, PN 16	10K	32	1.26	-	-	-	-
65	-	PN 16	-	-	10K	66	2.60	66	2.60	68	2.67
65 ¹⁾	-	PN 16	-	-	10K	38	1.50	-	-	-	-
80	3	PN 16	Class 150	Table E, PN 16	10K	79	3.11	79	3.11	80	3.15
80 ¹⁾	3	PN 16	Class 150	Table E, PN 16	10K	50	1.97	-	-	-	-
100	4	PN 16	Class 150	Table E, PN 16	10K	101	3.99	104	4.11	104	4.09
100 ¹⁾	4	PN 16	Class 150	Table E, PN 16	10K	66	2.60	-	-	-	-
125	-	PN 16	-	-	10K	127	4.99	130	5.11	129	5.08
125 ¹⁾	-	PN 16	-	-	10K	79	3.11	-	-	-	-
150	6	PN 16	Class 150	Table E, PN 16	10K	155	6.11	158	6.23	156	6.15
150 ¹⁾	6	PN 16	Class 150	Table E, PN 16	10K	102	4.02	-	-	-	-
200	8	PN 10	Class 150	Table E, PN 16	10K	204	8.02	207	8.14	202	7.96
200 ¹⁾	8	PN 16	Class 150	Table E, PN 16	10K	127	5.00	-	-	-	-
250	10	PN 10	Class 150	Table E, PN 16	10K	258	10.14	261	10.26	256	10.09
250 ¹⁾	10	PN 16	Class 150	Table E, PN 16	10K	156	6.14	-	-	-	-
300	12	PN 10	Class 150	Table E, PN 16	10K	309	12.15	312	12.26	306	12.03
300 ¹⁾	12	PN 16	Class 150	Table E, PN 16	10K	204	8.03	-	-	-	-
350	14	PN 10	Class 150	Table E, PN 16	10K	337	13.3	340	13.4	-	-
375	15	-	-	PN 16	10K	389	15.3	392	15.4	-	-
400	16	PN 10	Class 150	Table E, PN 16	10K	387	15.2	390	15.4	-	-
450	18	PN 10	Class 150	-	10K	436	17.2	439	17.3	-	-
500	20	PN 10	Class 150	Table E, PN 16	10K	487	19.2	490	19.3	-	-
600	24	PN 10	Class 150	Table E, PN 16	10K	585	23.0	588	23.1	-	-
700	28	PN 10	Class D	Table E, PN 16	10K	694	27.3	697	27.4	-	-
750	30	-	Class D	Table E, PN 16	10K	743	29.3	746	29.4	-	-

Nominal diameter		Pressure rating				Measuring tube internal diameter					
		EN (DIN)	ASME AWWA	AS 2129 AS 4087	JIS	Hard rubber		Polyurethane		PTFE	
[mm]	[in]					[mm]	[in]	[mm]	[in]	[mm]	[in]
800	32	PN 10	Class D	Table E, PN 16	-	794	31.3	797	31.4	-	-
900	36	PN 10	Class D	Table E, PN 16	-	895	35.2	898	35.4	-	-
1000	40	PN 6	Class D	Table E, PN 16	-	991	39.0	994	39.1	-	-
-	42	-	Class D	-	-	1043	41.1	1043	41.1	-	-
1200	48	PN 6	Class D	Table E, PN 16	-	1191	46.9	1197	47.1	-	-
-	54	-	Class D	-	-	1339	52.7	-	-	-	-
1400	-	PN 6	-	-	-	1402	55.2	-	-	-	-
-	60	-	Class D	-	-	1492	58.7	-	-	-	-
1600	-	PN 6	-	-	-	1600	63.0	-	-	-	-
-	66	-	Class D	-	-	1638	64.5	-	-	-	-
1800	72	PN 6	-	-	-	1786	70.3	-	-	-	-
-	78	-	Class D	-	-	1989	78.3	-	-	-	-
2000	-	PN 6	-	-	-	1989	78.3	-	-	-	-
-	84	-	Class D	-	-	2099	84.0	-	-	-	-
2200	-	PN 6	-	-	-	2194	87.8	-	-	-	-
-	90	-	Class D	-	-	2246	89.8	-	-	-	-
2400	-	PN 6	-	-	-	2391	94.1	-	-	-	-
-	96	-	Class D	-	-	2382	93.8	-	-	-	-
-	102	-	Class D	-	-	2533	99.7	-	-	-	-
2600	-	PN 6	-	-	-	2580	101.6	-	-	-	-
-	108	-	Class D	-	-	2683	105.6	-	-	-	-
2800	-	PN 6	-	-	-	2780	109.5	-	-	-	-
-	114	-	Class D	-	-	2832	111.5	-	-	-	-
3000	-	PN 6	-	-	-	2976	117.2	-	-	-	-
-	120	-	Class D	-	-	2980	117.3	-	-	-	-

1) Order code for "Design", option C

Materials

Transmitter housing

Compact version

- Order code for "Housing", option **A** "Compact, alu, coated":
Aluminum, AlSi10Mg, coated
- Order code for "Housing", option **M**: polycarbonate plastic
- Window material:
 - For order code for "Housing", option **A**: glass
 - For order code for "Housing", option **M**: plastic

Remote version (wall-mount housing)

- Order code for "Housing", option **P** "Remote, alu, coated":
Aluminum, AlSi10Mg, coated
- Order code for "Housing", option **N**: polycarbonate plastic
- Window material:
 - For order code for "Housing", option **P**: glass
 - For order code for "Housing", option **N**: plastic

Sensor connection housing

- Aluminum, AlSi10Mg, coated
- Polycarbonate plastic (only in conjunction with order code for "Sensor option", options CA, C3, CB, CC, CD, CD)

Cable entries/cable glands

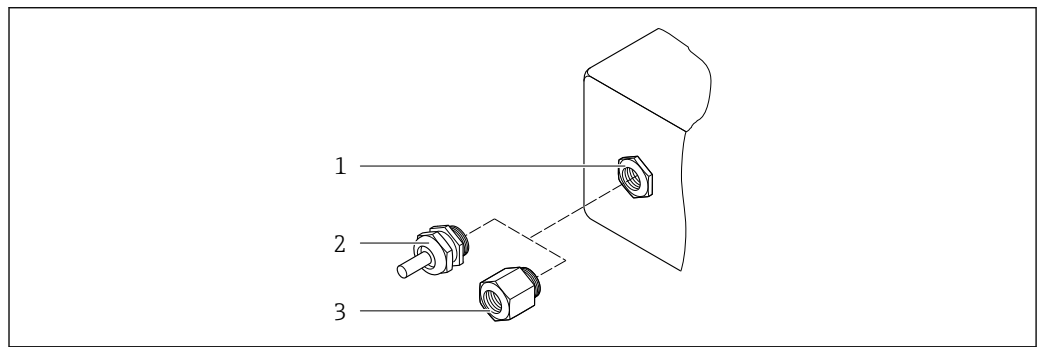

A0020640

33 Possible cable entries/cable glands

- 1 Female thread M20 × 1.5
- 2 Cable gland M20 × 1.5
- 3 Adapter for cable entry with female thread G ½" or NPT ½"

Compact and remote versions and sensor connection housing

Cable entry/cable gland	Material
Cable gland M20 × 1.5	<ul style="list-style-type: none"> ■ Plastic ■ Nickel-plated brass
Remote version: cable gland M20 × 1.5 Option of armored connecting cable	<ul style="list-style-type: none"> ■ Sensor connection housing: Nickel-plated brass ■ Transmitter wall-mount housing: Plastic
Adapter for cable entry with female thread G ½" or NPT ½"	Nickel-plated brass

Remote version connecting cable

i UV rays can impair the cable outer sheath. Protect the cable from exposure to sun as much as possible.

Electrode and coil current cable:

- Standard cable: PVC cable with copper shield
- Armored cable: PVC cable with copper shield and additional steel wire braided jacket

Sensor housing

- DN 25 to 300 (1 to 12")
 - Aluminum half-shell housing, aluminum, AlSi10Mg, coated
 - Fully welded carbon steel housing with protective varnish
- DN 350 to 3000 (14 to 120")
 - Fully welded carbon steel housing with protective varnish

Measuring tubes

- DN 25 to 600 (1 to 24")
 - Stainless steel: 1.4301, 1.4306, 304, 304L
- DN 700 to 3000 (28 to 120")
 - Stainless steel: 1.4301, 304



Liner

- DN 25 to 300 (1 to 12"): PTFE
- DN 25 to 1200 (1 to 48"): polyurethane
- DN 50 to 3000 (2 to 120"): hard rubber

Electrodes

- Stainless steel, 1.4435 (316L)
- Alloy C22, 2.4602 (UNS N06022)
- Tantalum

Process connections

-  For flanges made of carbon steel:
 - DN ≤ 300 (12"): with Al/Zn protective coating or protective varnish
 - DN ≥ 350 (14"): protective varnish
-  All carbon steel lap joint flanges are supplied with a hot-dip galvanized finish.

EN 1092-1 (DIN 2501)

Fixed flange

- Carbon steel:
 - DN ≤ 300: S235JRG2, S235JR+N, P245GH, A105, E250C
 - DN 350 to 3000: P245GH, S235JRG2, A105, E250C
- Stainless steel:
 - DN ≤ 300: 1.4404, 1.4571, F316L
 - DN 350 to 600: 1.4571, F316L, 1.4404
 - DN 700 to 1000: 1.4404, F316L

Lap joint flange

- Carbon steel DN ≤ 300: S235JRG2, A105, E250C
- Stainless steel DN ≤ 300: 1.4306, 1.4404, 1.4571, F316L

Lap joint flange, stamped plate

- Carbon steel DN ≤ 300: S235JRG2 similar to S235JR+AR or 1.0038
- Stainless steel DN ≤ 300: 1.4301 similar to 304

ASME B16.5

Fixed flange, lap joint flange

- Carbon steel: A105
- Stainless steel: F316L

JIS B2220

- Carbon steel: A105, A350 LF2
- Stainless steel: F316L

AWWA C207

Carbon steel: A105, P265GH, A181 Class 70, E250C, S275JR

AS 2129

Carbon steel: A105, E250C, P235GH, P265GH, S235JRG2

AS 4087

Carbon steel: A105, P265GH, S275JR

Seals

As per DIN EN 1514-1, form IBC

Accessories*Display guard*

Stainless steel, 1.4301 (304L)

Ground disks

- Stainless steel, 1.4435 (316L)
- Alloy C22, 2.4602 (UNS N06022)
- Tantalum

Fitted electrodes

Measurement, reference and empty pipe detection electrodes available as standard with:

- 1.4435 (316L)
- Alloy C22, 2.4602 (UNS N06022)
- Tantalum

Process connections

- EN 1092-1 (DIN 2501)
- ASME B16.5
- JIS B2220
- AS 2129 Table E
- AS 4087 PN 16
- AWWA C207 Class D



For information on the different materials used in the process connections → 197

Surface roughness

Electrodes with 1.4435 (316L); Alloy C22, 2.4602 (UNS N06022); tantalum:
< 0.5 µm (19.7 µin)

(All data relate to parts in contact with medium)

16.11 Human interface

Languages

Can be operated in the following languages:

- Via local operation:
 - English, German, French, Spanish, Italian, Dutch, Portuguese, Polish, Russian, Turkish, Chinese, Japanese, Bahasa (Indonesian), Vietnamese, Czech, Swedish
- Via "FieldCare", "DeviceCare" operating tool:
 - English, German, French, Spanish, Italian, Chinese, Japanese
- Via Web browser
 - English, German, French, Spanish, Italian, Dutch, Portuguese, Polish, Russian, Turkish, Chinese, Japanese, Bahasa (Indonesian), Vietnamese, Czech, Swedish

Local operation

Via display module

Equipment:

- Standard features 4-line, illuminated, graphic display; touch control
- Order code for "Display; operation", option BA "WLAN" offers standard equipment features in addition to access via Web browser

 Information about WLAN interface →  82

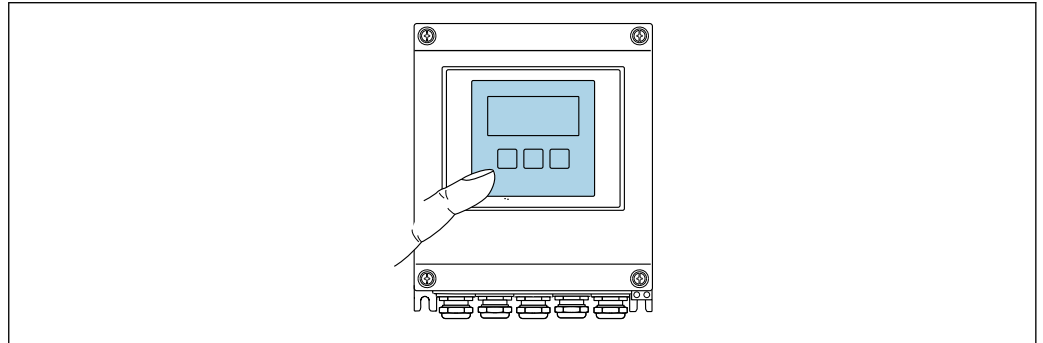



 34 Operation with touch control

Display elements

- 4-line, illuminated, graphic display
- White background lighting; switches to red in event of device errors
- Format for displaying measured variables and status variables can be individually configured
- Permitted ambient temperature for the display: -20 to $+60$ °C (-4 to $+140$ °F)
The readability of the display may be impaired at temperatures outside the temperature range.

Operating elements

- External operation via touch control (3 optical keys) without opening the housing: , , 
- Operating elements also accessible in the various zones of the hazardous area

Remote operation



→  81

Service interface

→  82

Supported operating tools

Different operating tools can be used for local or remote access to the measuring device. Depending on the operating tool used, access is possible with different operating units and via a variety of interfaces.

Supported operating tools	Operating unit	Interface	Additional information
Web browser	Notebook, PC or tablet with Web browser	<ul style="list-style-type: none"> ■ CDI-RJ45 service interface ■ WLAN interface 	Special Documentation for the device
DeviceCare SFE100	Notebook, PC or tablet with Microsoft Windows system	<ul style="list-style-type: none"> ■ CDI-RJ45 service interface ■ WLAN interface ■ Fieldbus protocol 	→  172
FieldCare SFE500	Notebook, PC or tablet with Microsoft Windows system	<ul style="list-style-type: none"> ■ CDI-RJ45 service interface ■ WLAN interface ■ Fieldbus protocol 	→  172

 Other operating tools based on FDT technology with a device driver such as DTM/iDTM or DD/EDD can be used for device operation. These operating tools are available from the individual manufacturers. Integration into the following operating tools, among others, is supported:

- Field Device Manager (FDM) from Honeywell → www.honeywellprocess.com
- FieldMate from Yokogawa → www.yokogawa.com
- PACTWare → www.pactware.com

The related device description files are available: www.endress.com → Downloads



Web server

Thanks to the integrated Web server, the device can be operated and configured via a Web browser and via a service interface (CDI-RJ45). The structure of the operating menu is the same as for the local display. In addition to the measured values, device status information is also displayed, allowing users to monitor the status of the device. Furthermore the device data can be managed and the network parameters can be configured.

Supported functions

Data exchange between the operating unit (such as a notebook for example) and the measuring device:

- Upload the configuration from the measuring device (XML format, configuration backup)
- Save the configuration to the measuring device (XML format, restore configuration)
- Export event list (.csv file)
- Export parameter settings (.csv file or PDF file, document the measuring point configuration)
- Export the Heartbeat verification log (PDF file, only available with the "Heartbeat Verification" application package)
- Flash firmware version for device firmware upgrade, for instance
- Download driver for system integration
- Visualize up to 1000 saved measured values (only available with the **Extended HistoROM** application package →  204)

 Web server special documentation →  205

HistoROM data management

The measuring device features HistoROM data management. HistoROM data management comprises both the storage and import/export of key device and process data, making operation and servicing far more reliable, secure and efficient.

Additional information on the data storage concept

There are different types of data storage units in which device data are stored and used by the device:

	HistoROM backup	T-DAT	S-DAT
Available data	<ul style="list-style-type: none"> ▪ Event logbook such as diagnostic events for example ▪ Device firmware package ▪ Driver for system integration for exporting via Web server, e.g. GSD for PROFIBUS DP 	<ul style="list-style-type: none"> ▪ Measured value logging ("Extended HistoROM" order option) ▪ Current parameter data record (used by firmware at run time) ▪ Peakhold indicator (min/max values) ▪ Totalizer values 	<ul style="list-style-type: none"> ▪ Sensor data: nominal diameter etc. ▪ Serial number ▪ Calibration data ▪ Device configuration (e.g. SW options, fixed I/O or multi I/O)
Storage location	Fixed on the user interface board in the connection compartment	Attachable to the user interface board in the connection compartment	In the sensor plug in the transmitter neck part

Data backup

Automatic

- The most important device data (sensor and transmitter) are automatically saved in the DAT modules
- If the transmitter or measuring device is replaced: once the T-DAT containing the previous device data has been exchanged, the new measuring device is ready for operation again immediately without any errors
- If the sensor is replaced: once the sensor has been replaced, new sensor data are transferred from the S-DAT in the measuring device and the measuring device is ready for operation again immediately without any errors

Data transmission

Manual

- Transfer of a device configuration to another device using the export function of the specific operating tool, e.g. with FieldCare, DeviceCare or Web server: to duplicate the configuration or to store in an archive (e.g. for backup purposes)
- Transmission of the drivers for system integration via Web server, e.g.: GSD for PROFIBUS DP

Event list

Automatic

- Chronological display of up to 20 event messages in the events list
- If the **Extended HistoROM** application package (order option) is enabled: up to 100 event messages are displayed in the events list along with a time stamp, plain text description and remedial measures
- The events list can be exported and displayed via a variety of interfaces and operating tools e.g. DeviceCare, FieldCare or Web server

Data logging

Manual

If the **Extended HistoROM** application package (order option) is enabled:



- Record up to 1 000 measured values via 1 to 4 channels
- User configurable recording interval
- Record up to 250 measured values via each of the 4 memory channels
- Export the measured value log via a variety of interfaces and operating tools e.g. FieldCare, DeviceCare or web server

16.12 Certificates and approvals

Current certificates and approvals for the product are available via the Product Configurator at www.endress.com.

1. Select the product using the filters and search field.
2. Open the product page.

The **Configuration** button opens the Product Configurator.

CE mark	<p>The device meets the legal requirements of the applicable EU Directives. These are listed in the corresponding EU Declaration of Conformity along with the standards applied.</p> <p>Endress+Hauser confirms successful testing of the device by affixing to it the CE mark.</p>
UKCA marking	<p>The device meets the legal requirements of the applicable UK regulations (Statutory Instruments). These are listed in the UKCA Declaration of Conformity along with the designated standards. By selecting the order option for UKCA marking, Endress+Hauser confirms a successful evaluation and testing of the device by affixing the UKCA mark.</p> <p>Contact address Endress+Hauser UK: Endress+Hauser Ltd. Floats Road Manchester M23 9NF United Kingdom www.uk.endress.com</p>
RCM mark	<p>The measuring system meets the EMC requirements of the "Australian Communications and Media Authority (ACMA)".</p>
Ex approval	<p>The devices are certified for use in hazardous areas and the relevant safety instructions are provided in the separate "Control Drawing" document. Reference is made to this document on the nameplate.</p>
Drinking water approval	<ul style="list-style-type: none"> ■ ACS ■ KTW/W270 ■ NSF 61 ■ WRAS BS 6920
PROFIBUS conformity	<p>PROFIBUS interface</p> <p>The measuring device is registered with PI (PROFIBUS and PROFINET International). It meets all the requirements of PROFIBUS PA Profile 3.02 specifications and can also be operated with certified devices of other manufacturers (interoperability).</p>
Radio approval	<p>The measuring device has radio approval.</p> <p> For detailed information regarding radio approval, see the Special Documentation →  205</p>
Measuring instrument approval	<p>The measuring device is (optionally) approved as a cold water meter (MI-001) for volume measurement in service subject to legal metrological control in accordance with the European Measuring Instruments Directive 2014/32/EU (MID).</p> <p>The measuring device is qualified to OIML R49: 2013.</p>

Other standards and guidelines

- EN 60529
Degrees of protection provided by enclosures (IP code)
- EN 61010-1
Safety requirements for electrical equipment for measurement, control and laboratory use - general requirements
- IEC/EN 61326-3-2
Emission in accordance with Class A requirements. Electromagnetic compatibility (EMC requirements).
- ANSI/ISA-61010-1 (82.02.01)
Safety Requirements for Electrical Equipment for Measurement, Control and Laboratory Use - Part 1 General Requirements
- CAN/CSA-C22.2 No. 61010-1-12
Safety Requirements for Electrical Equipment for Measurement, Control and Laboratory Use - Part 1 General Requirements
- NAMUR NE 21
Electromagnetic compatibility (EMC) of industrial process and laboratory control equipment
- NAMUR NE 32
Data retention in the event of a power failure in field and control instruments with microprocessors
- NAMUR NE 43
Standardization of the signal level for the breakdown information of digital transmitters with analog output signal.
- NAMUR NE 53
Software of field devices and signal-processing devices with digital electronics
- NAMUR NE 105
Specifications for integrating fieldbus devices in engineering tools for field devices
- NAMUR NE 107
Self-monitoring and diagnosis of field devices
- NAMUR NE 131
Requirements for field devices for standard applications

16.13 Application packages

Many different application packages are available to enhance the functionality of the device. Such packages might be needed to address safety aspects or specific application requirements.

The application packages can be ordered with the device or subsequently from Endress+Hauser. Detailed information on the order code in question is available from your local Endress+Hauser sales center or on the product page of the Endress+Hauser website: www.endress.com.

Cleaning

Package	Description
Electrode cleaning circuit (ECC)	The electrode cleaning circuit (ECC) function has been developed to have a solution for applications where magnetite (Fe_3O_4) deposits frequently occur (e.g. hot water). Since magnetite is highly conductive this build up leads to measuring errors and ultimately to the loss of signal. The application package is designed to avoid build-up of very conductive matter and thin layers (typical of magnetite).



Diagnostics functions

Package	Description
Extended HistoROM	<p>Comprises extended functions concerning the event log and the activation of the measured value memory.</p> <p>Event log: Memory volume is extended from 20 message entries (standard version) to up to 100 entries.</p> <p>Data logging (line recorder):</p> <ul style="list-style-type: none"> Memory capacity for up to 1000 measured values is activated. 250 measured values can be output via each of the 4 memory channels. The recording interval can be defined and configured by the user. Measured value logs can be accessed via the local display or operating tool e.g. FieldCare, DeviceCare or Web server.

Heartbeat Technology

Package	Description
Heartbeat Verification +Monitoring	<p>Heartbeat Verification Meets the requirement for traceable verification to DIN ISO 9001:2008 Chapter 7.6 a) "Control of monitoring and measuring equipment".</p> <ul style="list-style-type: none"> Functional testing in the installed state without interrupting the process. Traceable verification results on request, including a report. Simple testing process via local operation or other operating interfaces. Clear measuring point assessment (pass/fail) with high test coverage within the framework of manufacturer specifications. Extension of calibration intervals according to operator's risk assessment. <p>Heartbeat Monitoring Continuously supplies data, which are characteristic of the measuring principle, to an external condition monitoring system for the purpose of preventive maintenance or process analysis. These data enable the operator to:</p> <ul style="list-style-type: none"> Draw conclusions - using these data and other information - about the impact process influences (such as corrosion, abrasion, buildup etc.) have on the measuring performance over time. Schedule servicing in time. Monitor the process or product quality, e.g. gas pockets.

16.14 Accessories

 Overview of accessories available for order →  171

16.15 Supplementary documentation

-  For an overview of the scope of the associated Technical Documentation, refer to the following:
- W@M Device Viewer* (www.endress.com/deviceviewer): Enter the serial number from the nameplate
 - Endress+Hauser Operations App*: Enter the serial number from the nameplate or scan the matrix code on the nameplate

Standard documentation

Technical Information

Measuring device	Documentation code
Promag W 400	TI01046D

Brief Operating Instructions*Brief Operating Instructions for the sensor*

Measuring device	Documentation code
Proline Promag W	KA01266D

Brief Operating Instructions for the transmitter

Measuring device	Documentation code
Proline 400	KA01420D

Description of device parameters

Measuring device	Documentation code
Promag 400	GP01044D

Supplementary device-
dependent documentation

Special Documentation

Content	Documentation code
Web server	SD01813D
Heartbeat Verification + Monitoring application package	SD02569D
Display modules A309/A310	SD01793D

Installation Instructions

Content	Comment
Installation instructions for spare part sets and accessories	<ul style="list-style-type: none"> ▪ Access the overview of all the available spare part sets via <i>W@M Device Viewer</i> → 📄 169 ▪ Accessories available for order with Installation Instructions → 📄 171

Index

A

Access authorization to parameters	
Read access	74
Write access	74
Access code	74
Incorrect input	74
Adapters	26
Adapting the diagnostic behavior	134
Ambient temperature	
Influence	184
Ambient temperature range	25
Analog Input module	90
Analog Output module	92
Application	174
Applicator	174
Approvals	202

C

Cable entries	
Technical data	182
Cable entry	
Degree of protection	58
CE mark	10, 202
Certificates	202
Certification PROFIBUS	202
Checklist	
Post-connection check	59
Post-installation check	40
Cleaning	
Exterior cleaning	168
Interior cleaning	168
Commissioning	95
Advanced settings	105
Configuring the measuring device	96
Compatibility with earlier model	86
Conductivity	187
Connecting cable	41
Connecting the measuring device	47
Connection	
see Electrical connection	
Connection preparations	45
Connection tools	41
Context menu	
Calling up	69
Closing	69
Explanation	69
Current consumption	181
Cyclic data transmission	89

D

Date of manufacture	15
Declaration of Conformity	10
Define access code	116, 117
Degree of protection	58, 185
Design	
Measuring device	13

Designated use	9
Device components	13
Device description files	86
Device documentation	
Supplementary documentation	8
Device locking, status	119
Device master file	
GSD	86
Device name	
Sensor	15
Transmitter	15
Device repair	169
Device type ID	86
DeviceCare	84
Device description file	86
Diagnostic behavior	
Explanation	130
Symbols	130
Diagnostic information	
Design, description	130, 133
DeviceCare	132
FieldCare	132
Light emitting diodes	127
Local display	129
Overview	136
Remedial measures	136
Web browser	131
Diagnostic list	162
Diagnostic message	129
Diagnostics	
Symbols	129
Dimensions	25
DIP switch	
see Write protection switch	
Direct access	71
Direct access code	65
Disabling write protection	116
Discrete Input module	93
Discrete Output module	94
Display	
see Local display	
Display area	
For operational display	64
In the navigation view	66
Display values	
For locking status	119
Disposal	170
Document	
Function	6
Symbols	6
Document function	6
Down pipe	19
Drinking water approval	202

E

ECC	111
-----	-----

- Electrical connection
 - Degree of protection 58
 - Measuring device 41
 - Operating tools
 - Via PROFIBUS DP network 81
 - Via service interface (CDI-RJ45) 82
 - Via WLAN interface 82
 - Web server 82
 - WLAN interface 82
- Electromagnetic compatibility 186
- EMPTY_MODULE module 94
- Enabling write protection 116
- Enabling/disabling the keypad lock 75
- Endress+Hauser services
 - Maintenance 168
 - Repair 169
- Environment
 - Ambient temperature 25
 - Mechanical load 186
 - Storage temperature 184
 - Vibration- and shock-resistance 185
- Error messages
 - see Diagnostic messages
- Event list 162
- Event logbook 162
- Ex approval 202
- Extended order code
 - Sensor 15
 - Transmitter 15
- Exterior cleaning 168
- F**
 - Field of application
 - Residual risks 10
 - Field Xpert SMT70 85
 - Field Xpert SMT77 85
 - FieldCare 83
 - Device description file 86
 - Establishing a connection 84
 - Function 83
 - User interface 84
 - Filtering the event logbook 163
 - Firmware
 - Release date 86
 - Version 86
 - Firmware history 167
 - Fitted electrodes 198
 - Flow direction 21
 - Flow limit 188
 - Function check 95
 - Functions
 - see Parameters
- G**
 - Galvanic isolation 180
- H**
 - Hardware write protection 117
 - Heavy sensors 20
- Help text
 - Calling up 72
 - Closing 72
 - Explanation 72
- I**
 - I/O electronics module 13, 50
 - Identifying the measuring device 14
 - Immersion in water 27
 - Installation conditions 27
 - Incoming acceptance 14
 - Influence
 - Ambient temperature 184
 - Information on the document 6
 - Inlet runs 23
 - Input 174
 - Input mask 67
 - Inspection
 - Connection 59
 - Installation 40
 - Received goods 14
 - Installation 19
 - Installation conditions
 - Adapters 26
 - Dimensions 25
 - Down pipe 19
 - Heavy sensors 20
 - Inlet and outlet runs 23
 - Length of connecting cable 26
 - Mounting location 19
 - Orientation 21
 - Partially filled pipe 20
 - System pressure 25, 189
 - Vibrations 25, 189
 - Interior cleaning 168
- L**
 - Languages, operation options 198
 - Length of connecting cable 26
 - Line recorder 122
 - Local display 199
 - Editing view 67
 - Navigation view 65
 - see Diagnostic message
 - see In alarm condition
 - see Operational display
 - Low flow cut off 180
- M**
 - Main electronics module 13
 - Maintenance tasks 168
 - Manufacturer ID 86
 - Materials 195
 - Maximum measured error 182
 - Measured variables
 - Calculated 174
 - Measured 174
 - see Process variables
 - Measuring and test equipment 168

- Measuring device
 - Configuring 96
 - Conversion 169
 - Design 13
 - Disposal 170
 - Integrating via communication protocol 86
 - Mounting the sensor 29
 - Mounting the ground cable/ground disks 29
 - Mounting the seals 29
 - Screw tightening torques 30
 - Screw tightening torques, maximum 30
 - Screw tightening torques, nominal 35
 - Preparing for electrical connection 45
 - Preparing for mounting 29
 - Removing 170
 - Repairs 169
 - Switch-on 95
 - Measuring instrument approval 202
 - Measuring principle 174
 - Measuring range 174
 - Measuring system 174
 - Measuring tube specification 194
 - Mechanical load 186
 - Medium temperature range 187
 - Menu
 - Diagnostics 161
 - Setup 96, 97
 - Menus
 - For measuring device configuration 96
 - For specific settings 105
 - Module
 - Analog input 90
 - Analog output 92
 - Discrete Input 93
 - Discrete Output 94
 - EMPTY_MODULE 94
 - Totalizer
 - SETTOT_MODETOT_TOTAL 92
 - SETTOT_TOTAL 91
 - TOTAL 90
 - Mounting dimensions
 - see Dimensions
 - Mounting location 19
 - Mounting preparations 29
 - Mounting tool 28
- N**
- Nameplate
 - Sensor 15
 - Transmitter 15
 - Navigation path (navigation view) 65
 - Navigation view
 - In the submenu 65
 - In the wizard 65
 - Numeric editor 67
- O**
- Operable flow range 179
 - Operating elements 68, 130
 - Operating keys
 - see Operating elements
 - Operating menu
 - Menu, submenus 61
 - Structure 61
 - Submenus and user roles 62
 - Operating philosophy 62
 - Operation 119
 - Operation methods 60
 - Operational display 63
 - Operational safety 10
 - Order code 15
 - Orientation (vertical, horizontal) 21
 - Outlet runs 23
 - Output 179
 - Output signal 179
- P**
- Packaging disposal 18
 - Parameter
 - Changing 73
 - Entering a value 73
 - Parameter settings
 - Administration (Submenu) 115
 - Advanced setup (Submenu) 106
 - Analog inputs (Submenu) 102
 - Communication (Submenu) 99
 - Data logging (Submenu) 122
 - Define access code (Wizard) 114
 - Device information (Submenu) 165
 - Diagnostics (Menu) 161
 - Display (Submenu) 108
 - Display (Wizard) 99
 - Electrode cleaning cycle (Submenu) 111
 - Empty pipe detection (Wizard) 104
 - Low flow cut off (Wizard) 103
 - Process variables (Submenu) 119
 - Reset access code (Submenu) 114
 - Sensor adjustment (Submenu) 106
 - Setup (Menu) 97
 - Simulation (Submenu) 115
 - System units (Submenu) 98
 - Totalizer 1 to n (Submenu) 106, 120
 - Totalizer handling (Submenu) 121
 - Web server (Submenu) 80
 - WLAN settings (Wizard) 111
 - Partially filled pipe 20
 - Performance characteristics 182
 - Post-connection check (checklist) 59
 - Post-installation check 95
 - Post-installation check (checklist) 40
 - Potential equalization 52
 - Power consumption 181
 - Power supply failure 181
 - Pressure loss 188
 - Pressure tightness 187
 - Pressure-temperature ratings 187
 - Process conditions
 - Conductivity 187

- Flow limit 188
- Medium temperature 187
- Pressure loss 188
- Pressure tightness 187
- Process connections 198
- Product safety 10
- Profile version 86
- Protecting parameter settings 116
- R**
- Radio approval 202
- RCM mark 202
- Read access 74
- Reading measured values 119
- Recalibration 168
- Reference operating conditions 182
- Registered trademarks 8
- Remedial measures
 - Calling up 131
 - Closing 131
- Remote operation 199
- Remote version
 - Connecting the signal cables 47
- Repair 169
 - Notes 169
- Repair of a device 169
- Repeatability 184
- Replacement
 - Device components 169
- Requirements for personnel 9
- Return 169
- S**
- Safety 9
- Screw tightening torques 30
 - Maximum 30
 - Nominal 35
- Sensor
 - Mounting 29
- Serial number 15
- Setting the operating language 95
- Settings
 - Adapting the measuring device to the process conditions 121
 - Administration 113
 - Advanced display configurations 108
 - Analog input 102
 - Communication interface 99
 - Device reset 165
 - Device tag 97
 - Electrode cleaning circuit (ECC) 111
 - Empty pipe detection (EPD) 104
 - Local display 99
 - Low flow cut off 103
 - Operating language 95
 - Resetting the totalizer 121
 - Sensor adjustment 106
 - Simulation 115
 - System units 98
 - Totalizer 106
 - Totalizer reset 121
 - WLAN 111
- SETTOT_MODETOT_TOTAL module 92
- SETTOT_TOTAL module 91
- Showing data logging 122
- Signal on alarm 179
- Software release 86
- Spare part 169
- Spare parts 169
- Special connection instructions 56
- Standards and guidelines 203
- Status area
 - For operational display 63
 - In the navigation view 65
- Status signals 129, 132
- Storage concept 201
- Storage conditions 17
- Storage temperature 17
- Storage temperature range 184
- Structure
 - Operating menu 61
- Submenu
 - Administration 113, 115
 - Advanced setup 105, 106
 - Analog inputs 102
 - Communication 95, 99
 - Data logging 122
 - Device information 165
 - Display 108
 - Electrode cleaning cycle 111
 - Event list 162
 - Output values 119
 - Overview 62
 - Process variables 119
 - Reset access code 114
 - Sensor adjustment 106
 - Simulation 115
 - System units 98
 - Totalizer 1 to n 106, 120
 - Totalizer handling 121
 - Web server 80
- Supplementary documentation 204
- Supply voltage 181
- Surface roughness 198
- Symbols
 - For communication 63
 - For correction 67
 - For diagnostic behavior 63
 - For locking 63
 - For measured variable 64
 - For measurement channel number 64
 - For menus 66
 - For parameters 66
 - For status signal 63
 - For submenu 66
 - For wizard 66
 - In the status area of the local display 63
 - In the text and numeric editor 67

- System design
 - Measuring system 174
 - see Measuring device design
- System integration 86
- System pressure 25, 189
- T**
- Technical data, overview 174
- Temperature range
 - Ambient temperature range for display 199
 - Storage temperature 17
- Terminal assignment 43, 47, 50
- Terminals 181
- Text editor 67
- Tool
 - For mounting 28
- Tool tip
 - see Help text
- Tools
 - Electrical connection 41
 - Transport 17
- TOTAL module 90
- Totalizer
 - Assign process variable 120
 - Configuration 106
 - Operation 121
 - Reset 121
- Transmitter
 - Connecting the signal cables 50
 - Turning the display module 39
 - Turning the housing 37
- Transporting the measuring device 17
- Troubleshooting
 - General 126
- Turning the display module 39
- Turning the electronics housing
 - see Turning the transmitter housing
- Turning the transmitter housing 37
- U**
- UKCA marking 202
- Use in buried applications 28
 - Installation conditions 28
- Use in saline water 27
- Use of the measuring device
 - Borderline cases 9
 - Incorrect use 9
 - see Designated use
- User interface
 - Current diagnostic event 161
 - Previous diagnostic event 161
- User roles 62
- V**
- Version data for the device 86
- Vibration- and shock-resistance 185
- Vibrations 25, 189
- W**
- W@M 168, 169
- W@M Device Viewer 14, 169
- Weight
 - Transport (notes) 17
- Wizard
 - Define access code 114
 - Display 99
 - Empty pipe detection 104
 - Low flow cut off 103
 - WLAN settings 111
- WLAN settings 111
- Workplace safety 10
- Write access 74
- Write protection
 - Via access code 116
 - Via write protection switch 117
- Write protection switch 117



www.addresses.endress.com
