

Operating Instructions Proline Promag W 300 PROFIBUS PA

Electromagnetic flowmeter

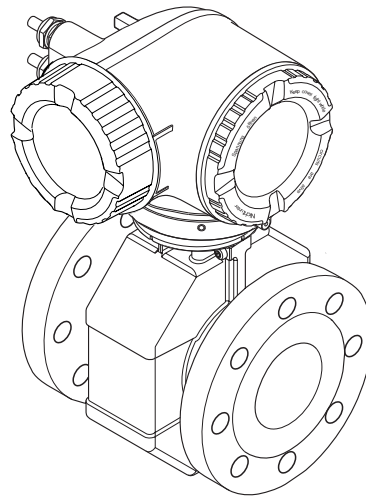

- Make sure the document is stored in a safe place such that it is always available when working on or with the device.
- To avoid danger to individuals or the facility, read the "Basic safety instructions" section carefully, as well as all other safety instructions in the document that are specific to working procedures.
- The manufacturer reserves the right to modify technical data without prior notice. Your Endress+Hauser Sales Center will supply you with current information and updates to these instructions.

Table of contents

1	About this document	6	6	Installation	21
1.1	Document function	6	6.1	Installation conditions	21
1.2	Symbols	6	6.1.1	Mounting position	21
1.2.1	Safety symbols	6	6.1.2	Environment and process requirements	23
1.2.2	Electrical symbols	6	6.1.3	Special mounting instructions	26
1.2.3	Communication symbols	6	6.2	Mounting the measuring device	26
1.2.4	Tool symbols	7	6.2.1	Required tools	26
1.2.5	Symbols for certain types of information	7	6.2.2	Preparing the measuring device	26
1.2.6	Symbols in graphics	7	6.2.3	Mounting the sensor	26
1.3	Documentation	8	6.2.4	Turning the transmitter housing	33
1.3.1	Standard documentation	8	6.2.5	Turning the display module	34
1.3.2	Supplementary device-dependent documentation	8	6.3	Post-installation check	35
1.4	Registered trademarks	8	7	Electrical connection	36
2	Safety instructions	9	7.1	Connection conditions	36
2.1	Requirements for the personnel	9	7.1.1	Required tools	36
2.2	Designated use	9	7.1.2	Requirements for connecting cable	36
2.3	Workplace safety	10	7.1.3	Terminal assignment	39
2.4	Operational safety	10	7.1.4	Device plugs available	39
2.5	Product safety	10	7.1.5	Pin assignment of device plug	39
2.6	IT security	11	7.1.6	Shielding and grounding	39
2.7	Device-specific IT security	11	7.1.7	Preparing the measuring device	40
2.7.1	Protecting access via hardware write protection	11	7.2	Connecting the measuring device	41
2.7.2	Protecting access via a password	11	7.2.1	Connecting the transmitter	41
2.7.3	Access via Web server	12	7.2.2	Connecting the remote display and operating module DKX001	44
2.7.4	Access via service interface (CDI-RJ45)	13	7.3	Ensuring potential equalization	44
3	Product description	14	7.3.1	Requirements	44
3.1	Product design	14	7.3.2	Connection example, standard scenario	44
4	Incoming acceptance and product identification	15	7.3.3	Connection example in special situations	45
4.1	Incoming acceptance	15	7.4	Special connection instructions	46
4.2	Product identification	15	7.4.1	Connection examples	46
4.2.1	Transmitter nameplate	16	7.5	Hardware settings	49
4.2.2	Sensor nameplate	17	7.5.1	Setting the device address	49
4.2.3	Symbols on measuring device	18	7.5.2	Activating the default IP address	50
5	Storage and transport	19	7.6	Ensuring the degree of protection	50
5.1	Storage conditions	19	7.7	Post-connection check	51
5.2	Transporting the product	19	8	Operation options	52
5.2.1	Measuring devices without lifting lugs	19	8.1	Overview of operation options	52
5.2.2	Measuring devices with lifting lugs	20	8.2	Structure and function of the operating menu	53
5.2.3	Transporting with a fork lift	20	8.2.1	Structure of the operating menu	53
5.3	Packaging disposal	20	8.2.2	Operating philosophy	54
			8.3	Access to the operating menu via the local display	55
			8.3.1	Operational display	55
			8.3.2	Navigation view	57
			8.3.3	Editing view	59
			8.3.4	Operating elements	61
			8.3.5	Opening the context menu	61

8.3.6	Navigating and selecting from list . . .	63	10.6.3	Configuring communication interface	94
8.3.7	Calling the parameter directly	63	10.6.4	Configuring the analog inputs	95
8.3.8	Calling up help text	64	10.6.5	Displaying the I/O configuration	95
8.3.9	Changing the parameters	64	10.6.6	Configuring the current input	96
8.3.10	User roles and related access authorization	65	10.6.7	Configuring the status input	97
8.3.11	Disabling write protection via access code	65	10.6.8	Configuring the current output	98
8.3.12	Enabling and disabling the keypad lock	66	10.6.9	Configuring the pulse/frequency/switch output	101
8.4	Access to the operating menu via the Web browser	66	10.6.10	Configuring the relay output	107
8.4.1	Function range	66	10.6.11	Configuring the local display	108
8.4.2	Prerequisites	67	10.6.12	Configuring the low flow cut off	110
8.4.3	Establishing a connection	68	10.6.13	Configuring empty pipe detection	111
8.4.4	Logging on	70	10.7	Advanced settings	112
8.4.5	User interface	71	10.7.1	Carrying out a sensor adjustment	113
8.4.6	Disabling the Web server	72	10.7.2	Configuring the totalizer	113
8.4.7	Logging out	72	10.7.3	Carrying out additional display configurations	115
8.5	Access to the operating menu via the operating tool	73	10.7.4	Performing electrode cleaning	118
8.5.1	Connecting the operating tool	73	10.7.5	WLAN configuration	118
8.5.2	FieldCare	75	10.7.6	Configuration management	120
8.5.3	DeviceCare	77	10.7.7	Using parameters for device administration	121
8.5.4	SIMATIC PDM	77	10.8	Simulation	123
9	System integration	79	10.9	Protecting settings from unauthorized access	126
9.1	Overview of device description files	79	10.9.1	Write protection via access code	126
9.1.1	Current version data for the device	79	10.9.2	Write protection via write protection switch	127
9.1.2	Operating tools	79	11	Operation	129
9.2	Device master file (GSD)	79	11.1	Reading the device locking status	129
9.2.1	Manufacturer-specific GSD	80	11.2	Adjusting the operating language	129
9.2.2	Profile GSD	80	11.3	Configuring the display	129
9.3	Compatibility with earlier model	81	11.4	Reading measured values	129
9.3.1	Automatic identification (factory setting)	81	11.4.1	"Process variables" submenu	130
9.3.2	Manual setting	81	11.4.2	Totalizer	130
9.3.3	Replacing the measuring devices without changing the GSD file or restarting the controller	81	11.4.3	"Input values" submenu	131
9.4	Using the GSD modules of the previous model	82	11.4.4	Output values	132
9.4.1	Using the CONTROL_BLOCK module in the previous model	82	11.5	Adapting the measuring device to the process conditions	134
9.5	Cyclic data transmission	84	11.6	Performing a totalizer reset	134
9.5.1	Block model	84	11.7	Showing data logging	135
9.5.2	Description of the modules	84	12	Diagnostics and troubleshooting	139
10	Commissioning	90	12.1	General troubleshooting	139
10.1	Function check	90	12.2	Diagnostic information via light emitting diodes	142
10.2	Switching on the measuring device	90	12.2.1	Transmitter	142
10.3	Connecting via FieldCare	90	12.3	Diagnostic information on local display	143
10.4	Configuring the device address via software	90	12.3.1	Diagnostic message	143
10.4.1	PROFIBUS network	90	12.3.2	Calling up remedial measures	145
10.5	Setting the operating language	90	12.4	Diagnostic information in the Web browser	145
10.6	Configuring the measuring device	91	12.4.1	Diagnostic options	145
10.6.1	Defining the tag name	92	12.4.2	Calling up remedy information	146
10.6.2	Setting the system units	93	12.5	Diagnostic information in FieldCare or DeviceCare	146
			12.5.1	Diagnostic options	146

12.5.2	Calling up remedy information	147	16.10	Mechanical construction	204
12.6	Adapting the diagnostic information	148	16.11	Human interface	213
12.6.1	Adapting the diagnostic behavior . . .	148	16.12	Certificates and approvals	217
12.7	Overview of diagnostic information	151	16.13	Application packages	218
12.7.1	Diagnostic of sensor	151	16.14	Accessories	219
12.7.2	Diagnostic of electronic	153	16.15	Supplementary documentation	219
12.7.3	Diagnostic of configuration	162			
12.7.4	Diagnostic of process	170			
12.8	Pending diagnostic events	174	Index		222
12.9	Diagnostic list	175			
12.10	Event logbook	175			
12.10.1	Reading out the event logbook	175			
12.10.2	Filtering the event logbook	176			
12.10.3	Overview of information events	176			
12.11	Resetting the measuring device	177			
12.11.1	Function scope of the "Device reset" parameter	178			
12.12	Device information	178			
12.13	Firmware history	180			
13	Maintenance	181			
13.1	Maintenance tasks	181			
13.1.1	Exterior cleaning	181			
13.1.2	Interior cleaning	181			
13.1.3	Replacing seals	181			
13.2	Measuring and test equipment	181			
13.3	Endress+Hauser services	181			
14	Repair	182			
14.1	General notes	182			
14.1.1	Repair and conversion concept	182			
14.1.2	Notes for repair and conversion	182			
14.2	Spare parts	182			
14.3	Endress+Hauser services	182			
14.4	Return	182			
14.5	Disposal	182			
14.5.1	Removing the measuring device	182			
14.5.2	Disposing of the measuring device . .	183			
15	Accessories	184			
15.1	Device-specific accessories	184			
15.1.1	For the transmitter	184			
15.1.2	For the sensor	185			
15.2	Service-specific accessories	185			
15.3	System components	185			
16	Technical data	186			
16.1	Application	186			
16.2	Function and system design	186			
16.3	Input	186			
16.4	Output	192			
16.5	Power supply	197			
16.6	Performance characteristics	198			
16.7	Installation	200			
16.8	Environment	200			
16.9	Process	201			

1 About this document

1.1 Document function

These Operating Instructions contain all the information that is required in various phases of the life cycle of the device: from product identification, incoming acceptance and storage, to mounting, connection, operation and commissioning through to troubleshooting, maintenance and disposal.

1.2 Symbols

1.2.1 Safety symbols

DANGER

This symbol alerts you to a dangerous situation. Failure to avoid this situation will result in serious or fatal injury.

WARNING

This symbol alerts you to a dangerous situation. Failure to avoid this situation can result in serious or fatal injury.





CAUTION

This symbol alerts you to a dangerous situation. Failure to avoid this situation can result in minor or medium injury.



NOTICE



This symbol contains information on procedures and other facts which do not result in personal injury.

1.2.2 Electrical symbols



Symbol	Meaning
	Direct current
	Alternating current
	Direct current and alternating current
	Ground connection A grounded terminal which, as far as the operator is concerned, is grounded via a grounding system.
	Protective Earth (PE) A terminal which must be connected to ground prior to establishing any other connections. The ground terminals are situated inside and outside the device: <ul style="list-style-type: none"> ▪ Inner ground terminal: Connects the protective earth to the mains supply. ▪ Outer ground terminal: Connects the device to the plant grounding system.

1.2.3 Communication symbols













Symbol	Meaning
	Wireless Local Area Network (WLAN) Communication via a wireless, local network.
	LED Light emitting diode is off.

Symbol	Meaning
	LED Light emitting diode is on.
	LED Light emitting diode is flashing.



1.2.4 Tool symbols



Symbol	Meaning
	Flat blade screwdriver
	Allen key
	Open-ended wrench

1.2.5 Symbols for certain types of information

Symbol	Meaning
	Permitted Procedures, processes or actions that are permitted.
	Preferred Procedures, processes or actions that are preferred.
	Forbidden Procedures, processes or actions that are forbidden.
	Tip Indicates additional information.
	Reference to documentation.
	Reference to page.
	Reference to graphic.
	Notice or individual step to be observed.
	Series of steps.
	Result of a step.
	Help in the event of a problem.
	Visual inspection.

1.2.6 Symbols in graphics



Symbol	Meaning
1, 2, 3, ...	Item numbers
	Series of steps
A, B, C, ...	Views
A-A, B-B, C-C, ...	Sections
	Hazardous area

Symbol	Meaning
	Safe area (non-hazardous area)
	Flow direction

1.3 Documentation

 For an overview of the scope of the associated Technical Documentation, refer to the following:

- *W@M Device Viewer* (www.endress.com/deviceviewer): Enter the serial number from nameplate
- *Endress+Hauser Operations App*: Enter the serial number from the nameplate or scan the 2D matrix code (QR code) on the nameplate

 Detailed list of the individual documents along with the documentation code
→  219

1.3.1 Standard documentation

Document type	Purpose and content of the document
Technical Information	Planning aid for your device The document contains all the technical data on the device and provides an overview of the accessories and other products that can be ordered for the device.
Sensor Brief Operating Instructions	Guides you quickly to the 1st measured value - Part 1 The Sensor Brief Operating Instructions are aimed at specialists with responsibility for installing the measuring device. <ul style="list-style-type: none"> ▪ Incoming acceptance and product identification ▪ Storage and transport ▪ Installation
Transmitter Brief Operating Instructions	Guides you quickly to the 1st measured value - Part 2 The Transmitter Brief Operating Instructions are aimed at specialists with responsibility for commissioning, configuring and parameterizing the measuring device (until the first measured value). <ul style="list-style-type: none"> ▪ Product description ▪ Installation ▪ Electrical connection ▪ Operation options ▪ System integration ▪ Commissioning ▪ Diagnostic information
Description of Device Parameters	Reference for your parameters The document provides a detailed explanation of each individual parameter in the Expert operating menu. The description is aimed at those who work with the device over the entire life cycle and perform specific configurations.

1.3.2 Supplementary device-dependent documentation

Additional documents are supplied depending on the device version ordered: Always comply strictly with the instructions in the supplementary documentation. The supplementary documentation is an integral part of the device documentation.

1.4 Registered trademarks

PROFIBUS®

Registered trademark of the PROFIBUS User Organization, Karlsruhe, Germany

2 Safety instructions

2.1 Requirements for the personnel

The personnel for installation, commissioning, diagnostics and maintenance must fulfill the following requirements:

- ▶ Trained, qualified specialists must have a relevant qualification for this specific function and task.
- ▶ Are authorized by the plant owner/operator.
- ▶ Are familiar with federal/national regulations.
- ▶ Before starting work, read and understand the instructions in the manual and supplementary documentation as well as the certificates (depending on the application).
- ▶ Follow instructions and comply with basic conditions.

The operating personnel must fulfill the following requirements:

- ▶ Are instructed and authorized according to the requirements of the task by the facility's owner-operator.
- ▶ Follow the instructions in this manual.

2.2 Designated use

Application and media

The measuring device described in these Brief Operating Instructions is intended only for flow measurement of liquids with a minimum conductivity of 5 $\mu\text{S}/\text{cm}$.

Depending on the version ordered, the measuring device can also measure potentially explosive, flammable, poisonous and oxidizing media.

Measuring devices for use in hazardous areas, in hygienic applications or where there is an increased risk due to process pressure, are labeled accordingly on the nameplate.

To ensure that the measuring device remains in proper condition for the operation time:

- ▶ Keep within the specified pressure and temperature range.
- ▶ Only use the measuring device in full compliance with the data on the nameplate and the general conditions listed in the Operating Instructions and supplementary documentation.
- ▶ Based on the nameplate, check whether the ordered device is permitted for the intended use in the hazardous area (e.g. explosion protection, pressure vessel safety).
- ▶ Use the measuring device only for media to which the process-wetted materials are sufficiently resistant.
- ▶ If the ambient temperature of the measuring device is outside the atmospheric temperature, it is absolutely essential to comply with the relevant basic conditions as specified in the device documentation. →  8
- ▶ Protect the measuring device permanently against corrosion from environmental influences.

Incorrect use

Non-designated use can compromise safety. The manufacturer is not liable for damage caused by improper or non-designated use.

WARNING

Danger of breakage due to corrosive or abrasive fluids and ambient conditions!

- ▶ Verify the compatibility of the process fluid with the sensor material.
- ▶ Ensure the resistance of all fluid-wetted materials in the process.
- ▶ Keep within the specified pressure and temperature range.

NOTICE**Verification for borderline cases:**

- ▶ For special fluids and fluids for cleaning, Endress+Hauser is glad to provide assistance in verifying the corrosion resistance of fluid-wetted materials, but does not accept any warranty or liability as minute changes in the temperature, concentration or level of contamination in the process can alter the corrosion resistance properties.

Residual risks**⚠ WARNING**

The electronics and the medium may cause the surfaces to heat up. This presents a burn hazard!

- ▶ For elevated fluid temperatures, ensure protection against contact to prevent burns.

2.3 Workplace safety

For work on and with the device:

- ▶ Wear the required personal protective equipment according to federal/national regulations.

For welding work on the piping:

- ▶ Do not ground the welding unit via the measuring device.

If working on and with the device with wet hands:

- ▶ Due to the increased risk of electric shock, gloves must be worn.

2.4 Operational safety

Risk of injury.

- ▶ Operate the device in proper technical condition and fail-safe condition only.
- ▶ The operator is responsible for interference-free operation of the device.

Conversions to the device

Unauthorized modifications to the device are not permitted and can lead to unforeseeable dangers.

- ▶ If, despite this, modifications are required, consult with Endress+Hauser.

Repair

To ensure continued operational safety and reliability,

- ▶ Carry out repairs on the device only if they are expressly permitted.
- ▶ Observe federal/national regulations pertaining to repair of an electrical device.
- ▶ Use original spare parts and accessories from Endress+Hauser only.

2.5 Product safety

This measuring device is designed in accordance with good engineering practice to meet state-of-the-art safety requirements, has been tested, and left the factory in a condition in which it is safe to operate.

It meets general safety standards and legal requirements. It also complies with the EU directives listed in the device-specific EU Declaration of Conformity. Endress+Hauser confirms this by affixing the CE mark to the device.





2.6 IT security

Our warranty is valid only if the device is installed and used as described in the Operating Instructions. The device is equipped with security mechanisms to protect it against any inadvertent changes to the settings.

IT security measures, which provide additional protection for the device and associated data transfer, must be implemented by the operators themselves in line with their security standards.

2.7 Device-specific IT security

The device offers a range of specific functions to support protective measures on the operator's side. These functions can be configured by the user and guarantee greater in-operation safety if used correctly. An overview of the most important functions is provided in the following section.

Function/interface	Factory setting	Recommendation
Write protection via hardware write protection switch →  11	Not enabled.	On an individual basis following risk assessment.
Access code (also applies for Web server login or FieldCare connection) →  12	Not enabled (0000).	Assign a customized access code during commissioning.
WLAN (order option in display module)	Enabled.	On an individual basis following risk assessment.
WLAN security mode	Enabled (WPA2-PSK)	Do not change.
WLAN passphrase (password) →  12	Serial number	Assign an individual WLAN passphrase during commissioning.
WLAN mode	Access Point	On an individual basis following risk assessment.
Web server →  12	Enabled.	On an individual basis following risk assessment.
CDI-RJ45 service interface →  13	–	On an individual basis following risk assessment.

2.7.1 Protecting access via hardware write protection

Write access to the device parameters via the local display, Web browser or operating tool (e.g. FieldCare, DeviceCare) can be disabled via a write protection switch (DIP switch on the motherboard). When hardware write protection is enabled, only read access to the parameters is possible.

Hardware write protection is disabled when the device is delivered →  127.

2.7.2 Protecting access via a password

Different passwords are available to protect write access to the device parameters or access to the device via the WLAN interface.

- **User-specific access code**
Protect write access to the device parameters via the local display, Web browser or operating tool (e.g. FieldCare, DeviceCare). Access authorization is clearly regulated through the use of a user-specific access code.
- **WLAN passphrase**
The network key protects a connection between an operating unit (e.g. notebook or tablet) and the device via the WLAN interface which can be ordered as an option.
- **Infrastructure mode**
When the device is operated in infrastructure mode, the WLAN passphrase corresponds to the WLAN passphrase configured on the operator side.

User-specific access code

Write access to the device parameters via the local display, Web browser or operating tool (e.g. FieldCare, DeviceCare) can be protected by the modifiable, user-specific access code (→  126).

When the device is delivered, the device does not have an access code and is equivalent to 0000 (open).

WLAN passphrase: Operation as WLAN access point

A connection between an operating unit (e.g. notebook or tablet) and the device via the WLAN interface (→  74), which can be ordered as an optional extra, is protected by the network key. The WLAN authentication of the network key complies with the IEEE 802.11 standard.

When the device is delivered, the network key is pre-defined depending on the device. It can be changed via the **WLAN settings** submenu in the **WLAN passphrase** parameter (→  120).

Infrastructure mode

A connection between the device and WLAN access point is protected by means of an SSID and passphrase on the system side. Please contact the relevant system administrator for access.

General notes on the use of passwords

- The access code and network key supplied with the device should be changed during commissioning.
- Follow the general rules for generating a secure password when defining and managing the access code or network key.
- The user is responsible for the management and careful handling of the access code and network key.
- For information on configuring the access code or on what to do if you lose the password, see the "Write protection via access code" section →  126

2.7.3 Access via Web server

The device can be operated and configured via a Web browser with the integrated Web server (→  66). The connection is via the service interface (CDI-RJ45) or the WLAN interface.

The Web server is enabled when the device is delivered. The Web server can be disabled if necessary (e.g. after commissioning) via the **Web server functionality** parameter.

The device and status information can be hidden on the login page. This prevents unauthorized access to the information.

 For detailed information on device parameters, see:
The "Description of Device Parameters" document →  220.

2.7.4 Access via service interface (CDI-RJ45)

The device can be connected to a network via the service interface (CDI-RJ45). Device-specific functions guarantee the secure operation of the device in a network.

The use of relevant industrial standards and guidelines that have been defined by national and international safety committees, such as IEC/ISA62443 or the IEEE, is recommended. This includes organizational security measures such as the assignment of access authorization as well as technical measures such as network segmentation.



Transmitters with an Ex de approval may not be connected via the service interface (CDI-RJ45)!

Order code for "Approval transmitter + sensor", options (Ex de): BA, BB, C1, C2, GA, GB, MA, MB, NA, NB

3 Product description

The device consists of a transmitter and a sensor.

The device is available as a compact version:

The transmitter and sensor form a mechanical unit.

3.1 Product design

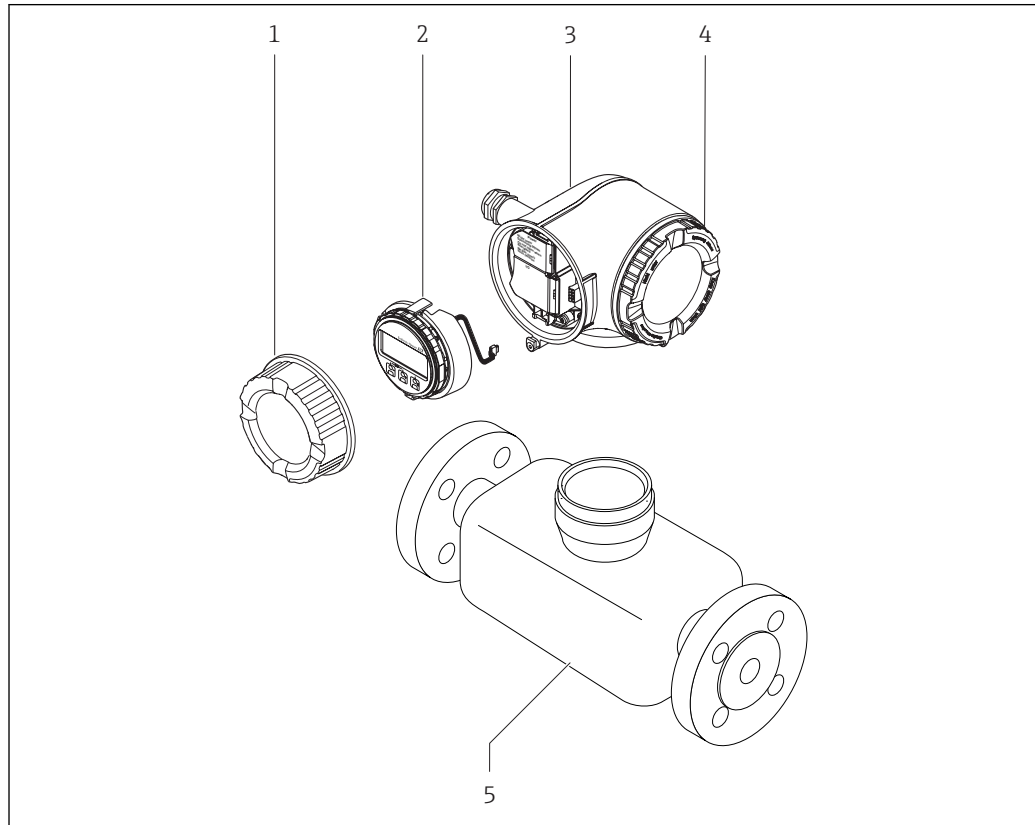

A0029586

☐ 1 *Important components of a measuring device*

- 1 *Connection compartment cover*
- 2 *Display module*
- 3 *Transmitter housing*
- 4 *Electronics compartment cover*
- 5 *Sensor*

4 Incoming acceptance and product identification

4.1 Incoming acceptance

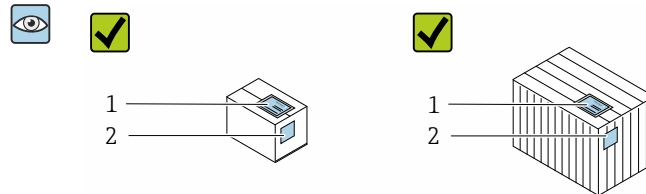

Are the order codes on the delivery note (1) and the product sticker (2) identical?

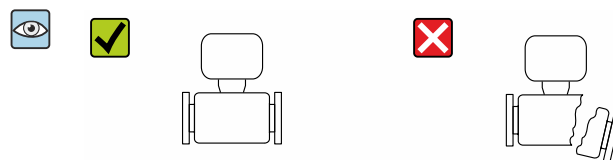
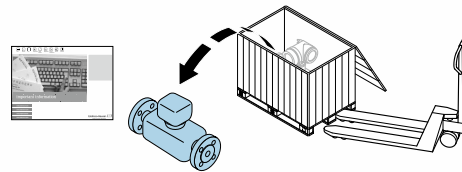

Are the goods undamaged?

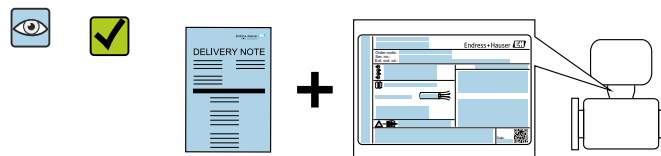

Do the nameplate data match the ordering information on the delivery note?

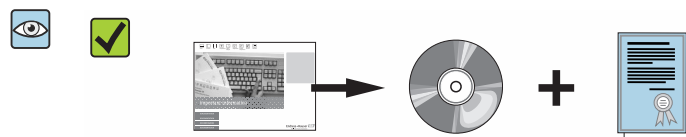

Is the document folder present with accompanying documents?
Is the optional CD-ROM with the Technical Documentation present?

- i** ■ If one of the conditions is not satisfied, contact your Endress+Hauser Sales Center.
- Depending on the device version, the CD-ROM might not be part of the delivery!
The Technical Documentation is available via the Internet or via the *Endress+Hauser Operations App*, see the "Product identification" section → 16.

4.2 Product identification

The following options are available for identification of the device:

- Nameplate specifications
- Order code with breakdown of the device features on the delivery note
- Enter serial numbers from nameplates in the *W@M Device Viewer* (www.endress.com/deviceviewer): All information about the device is displayed.
- Enter the serial number from nameplates in the *Endress+Hauser Operations App* or scan the 2-D matrix code (QR code) on the nameplate using the *Endress+Hauser Operations App*: All information about the device is displayed.

For an overview of the scope of the associated Technical Documentation, refer to the following:

- The "Additional standard documentation on the device" → 8 and "Supplementary device-dependent documentation" → 8 sections
- The *W@M Device Viewer*: enter the serial number from the nameplate (www.endress.com/deviceviewer)
- The *Endress+Hauser Operations App*: Enter the serial number from the nameplate or scan the 2-D matrix code (QR code) on the nameplate.

4.2.1 Transmitter nameplate

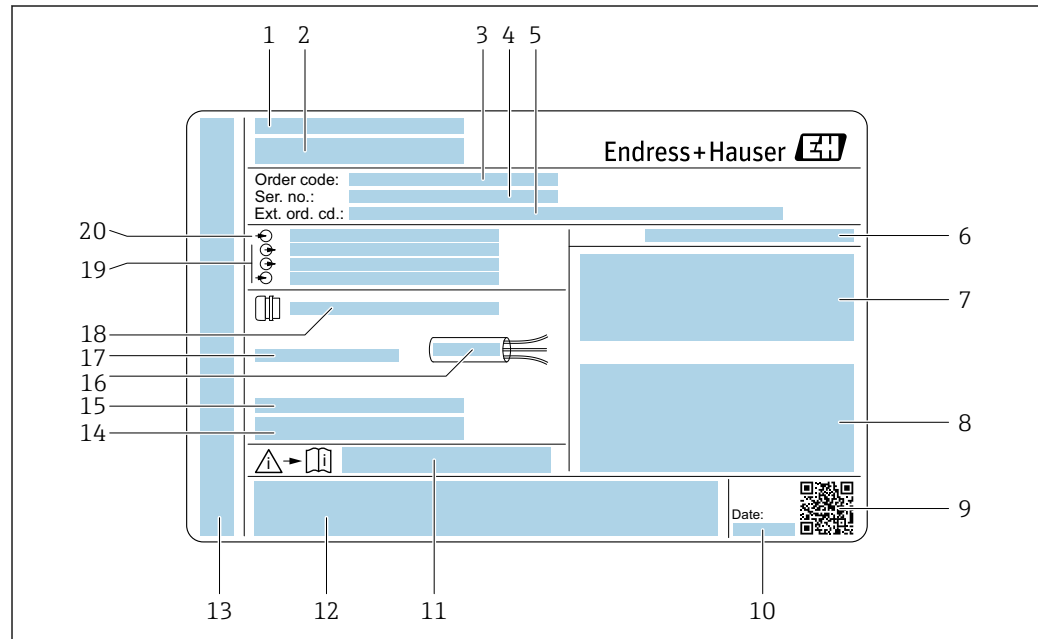

A0029192

2 Example of a transmitter nameplate

- 1 Manufacturing location
- 2 Name of the transmitter
- 3 Order code
- 4 Serial number (ser. no.)
- 5 Extended order code (Ext. ord. cd.)
- 6 Degree of protection
- 7 Space for approvals: use in hazardous areas
- 8 Electrical connection data: available inputs and outputs
- 9 2-D matrix code
- 10 Manufacturing date: year-month
- 11 Document number of safety-related supplementary documentation
- 12 Space for approvals and certificates: e.g. CE mark, C-Tick
- 13 Space for degree of protection of connection and electronics compartment when used in hazardous areas
- 14 Firmware version (FW) and device revision (Dev.Rev.) from the factory
- 15 Space for additional information in the case of special products
- 16 Permitted temperature range for cable
- 17 Permitted ambient temperature (T_a)
- 18 Information on cable gland
- 19 Available inputs and outputs, supply voltage
- 20 Electrical connection data: supply voltage

4.2.2 Sensor nameplate

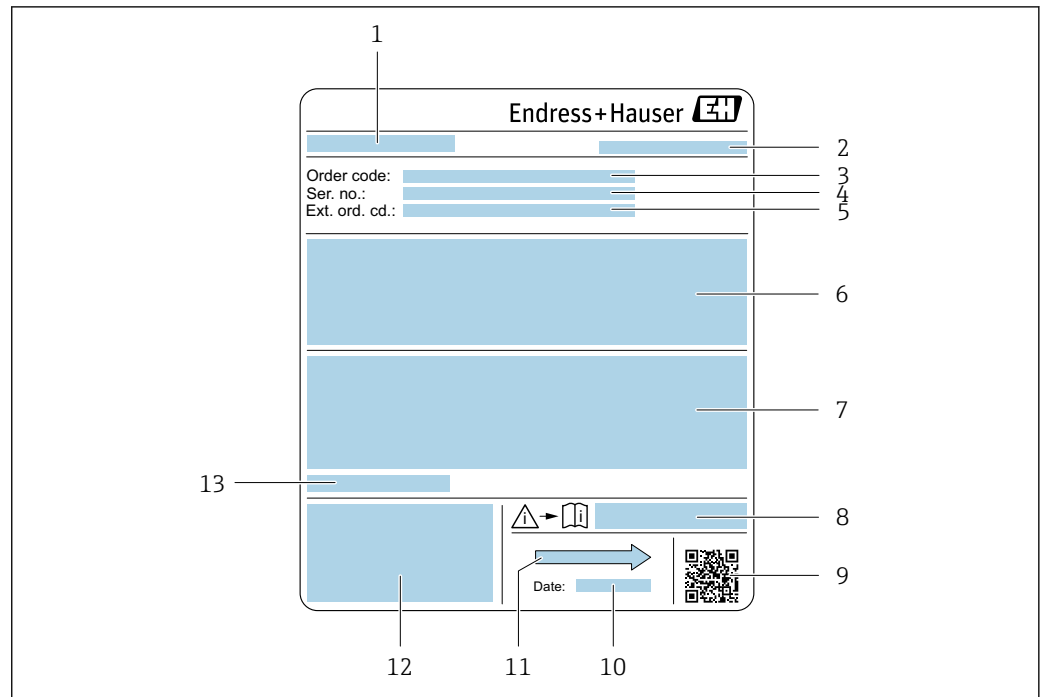

A0029205

3 Example of sensor nameplate

- 1 Name of the sensor
- 2 Place of manufacture
- 3 Order code
- 4 Serial number (ser. no.)
- 5 Extended order code (Ext. ord. cd.)
- 6 Flow; nominal diameter of the sensor; pressure rating; nominal pressure; system pressure; fluid temperature range; material of liner and electrodes
- 7 Approval information for explosion protection, Pressure Equipment Directive and degree of protection
- 8 Document number of safety-related supplementary documentation
- 9 2-D matrix code
- 10 Manufacturing date: year-month
- 11 Flow direction
- 12 CE mark, C-Tick
- 13 Permitted ambient temperature (T_a)



Order code

The measuring device is reordered using the order code.

Extended order code

- The device type (product root) and basic specifications (mandatory features) are always listed.
- Of the optional specifications (optional features), only the safety and approval-related specifications are listed (e.g. LA). If other optional specifications are also ordered, these are indicated collectively using the # placeholder symbol (e.g. #LA#).
- If the ordered optional specifications do not include any safety and approval-related specifications, they are indicated by the + placeholder symbol (e.g. XXXXXX-ABCDE+).

4.2.3 Symbols on measuring device

Symbol	Meaning
	WARNING! This symbol alerts you to a dangerous situation. Failure to avoid this situation can result in serious or fatal injury.
	Reference to documentation Refers to the corresponding device documentation.
	Protective ground connection A terminal which must be connected to ground prior to establishing any other connections.

5 Storage and transport

5.1 Storage conditions

Observe the following notes for storage:

- ▶ Store in the original packaging to ensure protection from shock.
- ▶ Do not remove protective covers or protective caps installed on process connections. They prevent mechanical damage to the sealing surfaces and contamination in the measuring tube.
- ▶ Protect from direct sunlight to avoid unacceptably high surface temperatures.
- ▶ Select a storage location where moisture cannot collect in the measuring device as fungus and bacteria infestation can damage the lining.
- ▶ Store in a dry and dust-free place.
- ▶ Do not store outdoors.

Storage temperature → 📄 200

5.2 Transporting the product

Transport the measuring device to the measuring point in the original packaging.

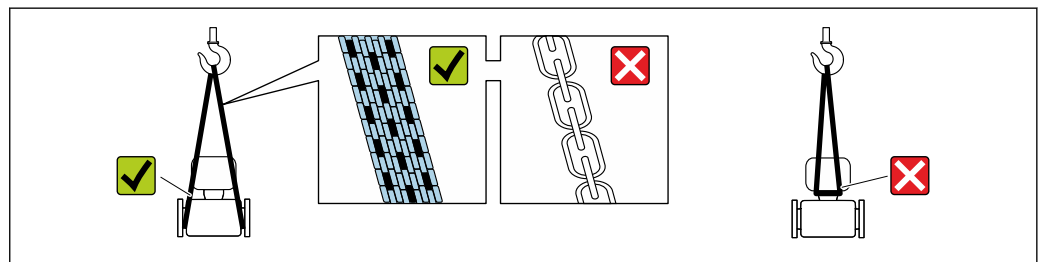

A0029252

- i** Do not remove protective covers or caps installed on process connections. They prevent mechanical damage to the sealing surfaces and contamination in the measuring tube.

5.2.1 Measuring devices without lifting lugs

⚠ WARNING

Center of gravity of the measuring device is higher than the suspension points of the webbing slings.

Risk of injury if the measuring device slips.

- ▶ Secure the measuring device against slipping or turning.
- ▶ Observe the weight specified on the packaging (stick-on label).

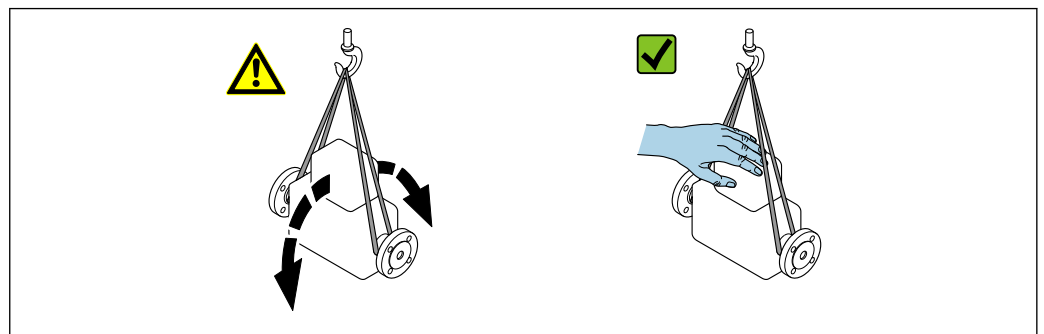

A0029214

5.2.2 Measuring devices with lifting lugs

⚠ CAUTION

Special transportation instructions for devices with lifting lugs

- ▶ Only use the lifting lugs fitted on the device or flanges to transport the device.
- ▶ The device must always be secured at two lifting lugs at least.

5.2.3 Transporting with a fork lift

If transporting in wood crates, the floor structure enables the crates to be lifted lengthwise or at both sides using a forklift.

⚠ CAUTION

Risk of damaging the magnetic coil

- ▶ If transporting by forklift, do not lift the sensor by the metal casing.
- ▶ This would buckle the casing and damage the internal magnetic coils.

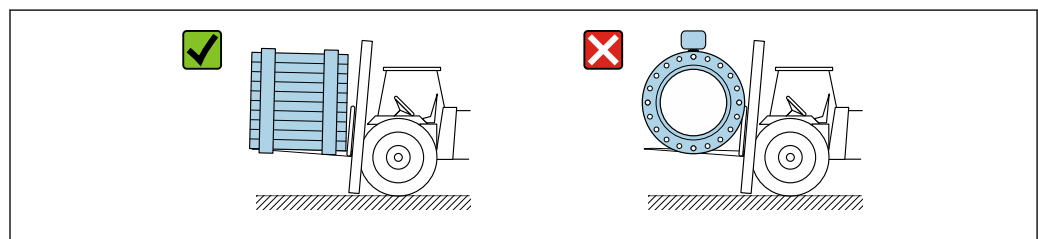

A0029319

5.3 Packaging disposal

All packaging materials are environmentally friendly and 100 % recyclable:

- Outer packaging of device
 - Polymer stretch wrap that complies with EU Directive 2002/95/EC (RoHS)
- Packaging
 - Wooden crate treated in accordance with ISPM 15 standard, confirmed by IPPC logo
 - Cardboard box in accordance with European packaging guideline 94/62EC, recyclability confirmed by Resy symbol
- Carrying and securing materials
 - Disposable plastic pallet
 - Plastic straps
 - Plastic adhesive strips
- Filler material
 - Paper pads

6 Installation

6.1 Installation conditions

6.1.1 Mounting position

Mounting location

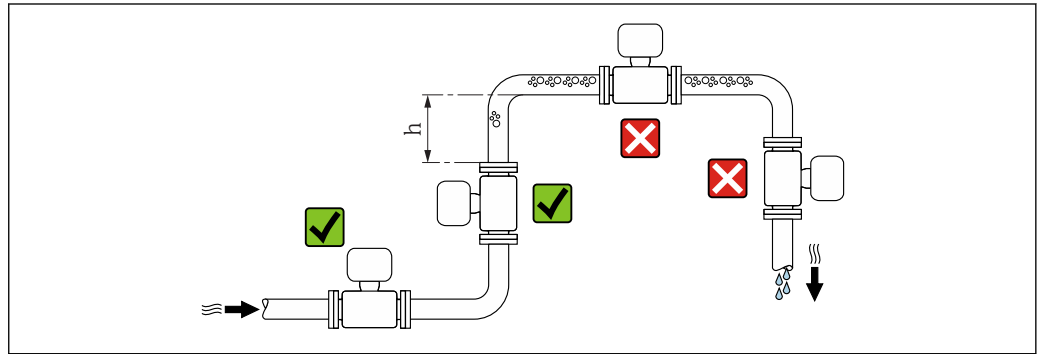

A0029343

Preferably install the sensor in an ascending pipe, and ensure a sufficient distance to the next pipe elbow: $h \geq 2 \times DN$.

 Distance $h \geq 2 \times DN$ not necessary with order code for "Design", option C, H, I.

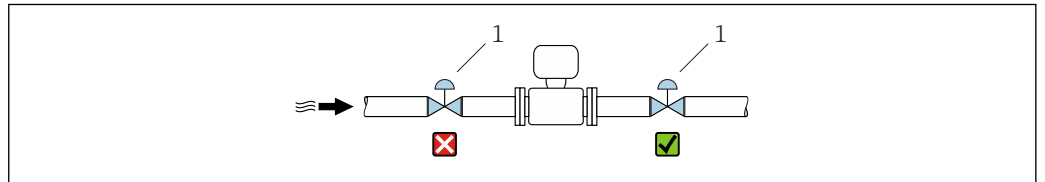

A0033017

 4 Installation of the sensor after a control valve is not recommended

1 Control valve

Installation in down pipes

Install a siphon with a vent valve downstream of the sensor in down pipes whose length $h \geq 5 \text{ m}$ (16.4 ft). This precaution is to avoid low pressure and the consequent risk of damage to the measuring tube. This measure also prevents the system losing prime.

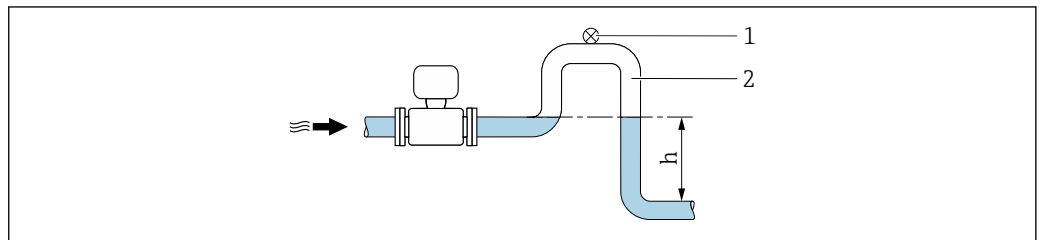

A0028981

 5 Installation in a down pipe

1 Vent valve

2 Pipe siphon

h Length of down pipe

Installation in partially filled pipes

A partially filled pipe with a gradient necessitates a drain-type configuration.

i No inlet runs necessary with order code for "Design", option C, H, I

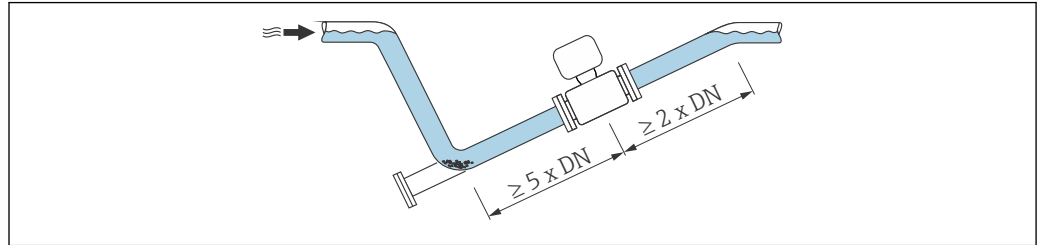

A0029257

For heavy sensors DN ≥ 350 (14")

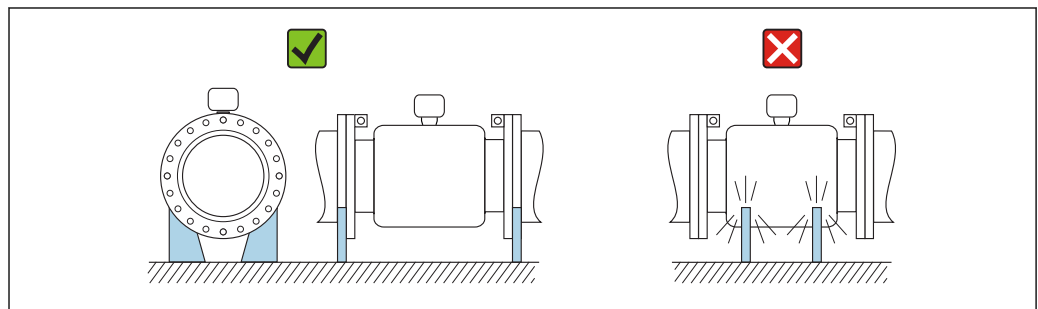

A0016276

Orientation

The direction of the arrow on the sensor nameplate helps you to install the sensor according to the flow direction (direction of medium flow through the piping).

Orientation		Recommendation
A	Vertical orientation	 A0015591 ✓✓
B	Horizontal orientation, transmitter at top	 A0015589 ✓✓ ¹⁾
C	Horizontal orientation, transmitter at bottom	 A0015590 ✓✓ ^{2) 3)} ✗ ⁴⁾
D	Horizontal orientation, transmitter at side	 A0015592 ✗

- 1) Applications with low process temperatures may decrease the ambient temperature. To maintain the minimum ambient temperature for the transmitter, this orientation is recommended.
- 2) Applications with high process temperatures may increase the ambient temperature. To maintain the maximum ambient temperature for the transmitter, this orientation is recommended.
- 3) To prevent the electronics module from overheating in the case of a sharp rise in temperature (e.g. CIP or SIP processes), install the device with the transmitter component pointing downwards.
- 4) With the empty pipe detection function switched on: empty pipe detection only works if the transmitter housing is pointing upwards.

Horizontal

- Ideally, the measuring electrode plane should be horizontal. This prevents brief insulation of the measuring electrodes by entrained air bubbles.
- Empty pipe detection only works if the transmitter housing is pointing upwards as otherwise there is no guarantee that the empty pipe detection function will actually respond to a partially filled or empty measuring tube.

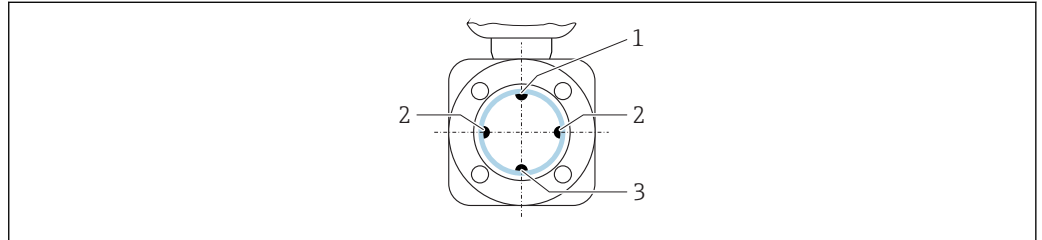

A0029344

- 1 EPD electrode for empty pipe detection
- 2 Measuring electrodes for signal detection
- 3 Reference electrode for potential equalization

Inlet and outlet runs

If possible, install the sensor upstream from fittings such as valves, T-pieces or elbows. Observe the following inlet and outlet runs to comply with accuracy specifications:

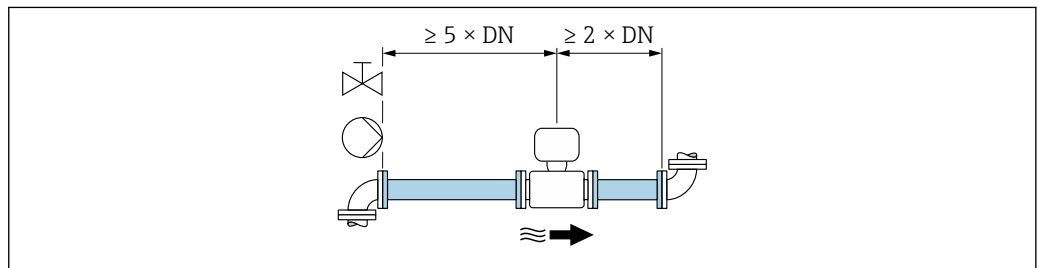

A0028997

For sensors with the order code for "Design", option C , H , I , no inlet or outlet runs need to be taken into account.

Installation dimensions

 For the dimensions and installation lengths of the device, see the "Technical Information" document, "Mechanical construction" section.

6.1.2 Environment and process requirements

Ambient temperature range

Transmitter	Standard: -40 to +60 °C (-40 to +140 °F)
Local display	-20 to +60 °C (-4 to +140 °F), the readability of the display may be impaired at temperatures outside the temperature range.
Sensor	<ul style="list-style-type: none"> ■ Process connection material, carbon steel: -10 to +60 °C (+14 to +140 °F) ■ Process connection material, stainless steel: -40 to +60 °C (-40 to +140 °F)
Liner	Do not exceed or fall below the permitted temperature range of the liner .

If operating outdoors:

- Install the measuring device in a shady location.
- Avoid direct sunlight, particularly in warm climatic regions.
- Avoid direct exposure to weather conditions.

System pressure

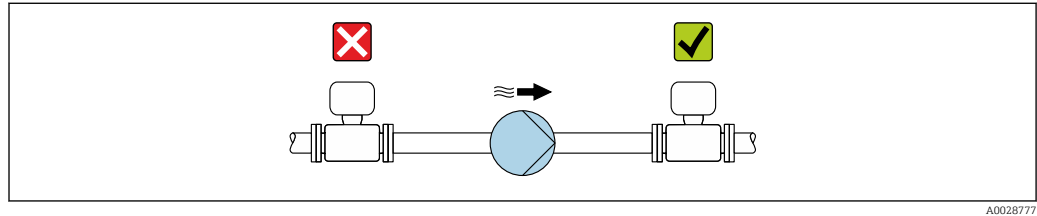

Never install the sensor on the pump suction side in order to avoid the risk of low pressure, and thus damage to the liner.

- i** Furthermore, install pulse dampers if reciprocating, diaphragm or peristaltic pumps are used.
- i**
 - Information on the liner's resistance to partial vacuum → 202
 - Information on the shock resistance of the measuring system
 - Information on the vibration resistance of the measuring system

Vibrations

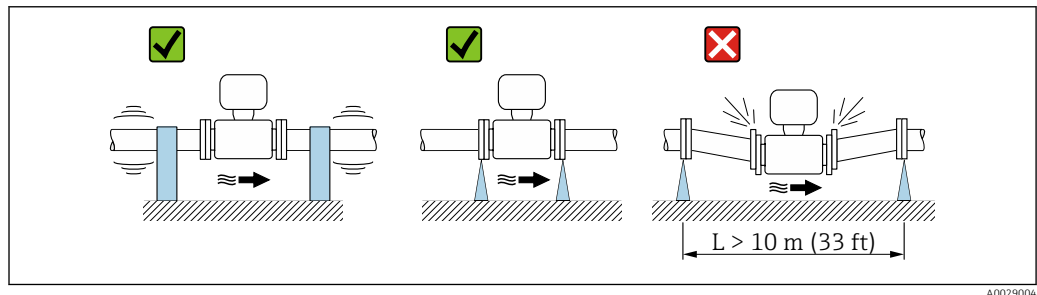

6 Measures to prevent vibration of the device

In the event of very strong vibrations, the pipe and sensor must be supported and fixed. It is also advisable to mount the sensor and transmitter separately.

- i**
 - Information on the shock resistance of the measuring system
 - Information on the vibration resistance of the measuring system

Thermal insulation

If process fluids are very hot, it is necessary to insulate pipes in order to reduce energy loss and to prevent individuals from accidentally coming into contact with hot pipes. Please observe the applicable standards and guidelines for insulating pipes.

⚠ WARNING

Electronics overheating on account of thermal insulation!

- ▶ The housing support is used for heat dissipation and must be completely free (i.e. uncovered). At the very maximum, the sensor insulation may extend as far as the upper edge of the two sensor half-shells.

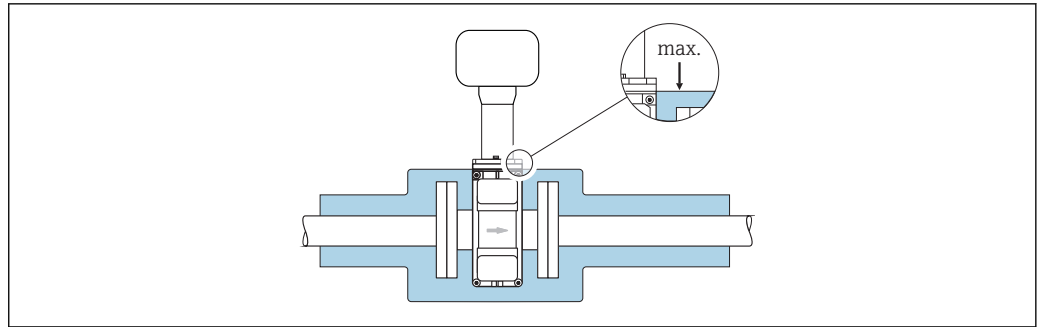

A0031216

Adapters

Suitable adapters to DIN EN 545 (double-flange reducers) can be used to install the sensor in larger-diameter pipes. The resultant increase in the rate of flow improves measuring accuracy with very slow-moving fluids. The nomogram shown here can be used to calculate the pressure loss caused by reducers and expanders.

i The nomogram only applies to liquids with a viscosity similar to that of water.

1. Calculate the ratio of the diameters d/D .
2. From the nomogram read off the pressure loss as a function of flow velocity (downstream from the reduction) and the d/D ratio.

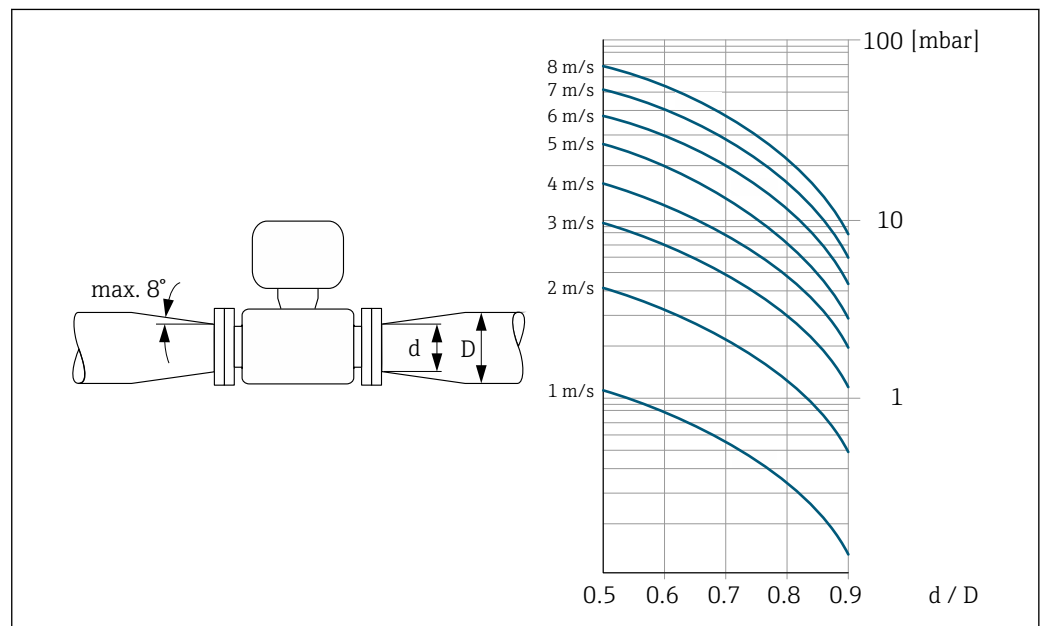

A0029002

6.1.3 Special mounting instructions

Protective cover

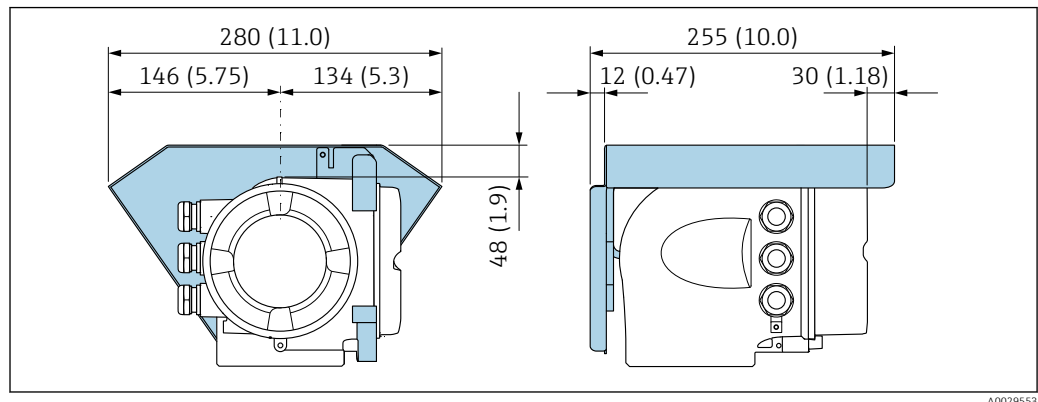

A0029553

6.2 Mounting the measuring device

6.2.1 Required tools

For sensor

For flanges and other process connections: Corresponding mounting tools

6.2.2 Preparing the measuring device

1. Remove all remaining transport packaging.
2. Remove any protective covers or protective caps present from the sensor.
3. Remove stick-on label on the electronics compartment cover.

6.2.3 Mounting the sensor

⚠ WARNING

Danger due to improper process sealing!

- ▶ Ensure that the inside diameters of the gaskets are greater than or equal to that of the process connections and piping.
 - ▶ Ensure that the gaskets are clean and undamaged.
 - ▶ Install the gaskets correctly.
1. Ensure that the direction of the arrow on the sensor matches the flow direction of the medium.
 2. To ensure compliance with device specifications, install the measuring device between the pipe flanges in a way that it is centered in the measurement section.
 3. If using ground disks, comply with the Installation Instructions provided.
 4. Observe required screw tightening torques → 27.

5. Install the measuring device or turn the transmitter housing so that the cable entries do not point upwards.

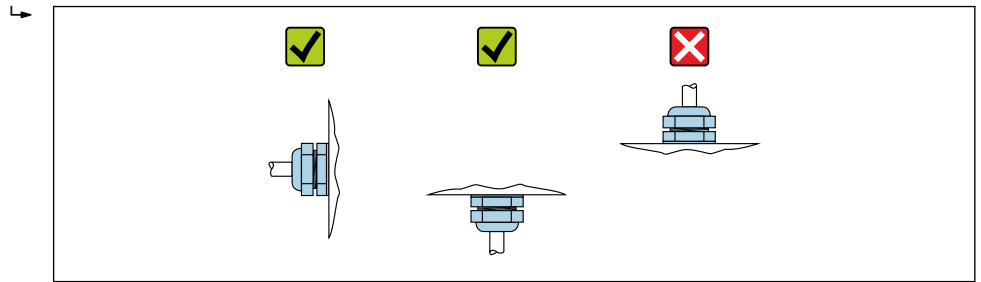

A0029263

Mounting the seals

CAUTION

An electrically conductive layer could form on the inside of the measuring tube!

Risk of measuring signal short circuit.

- ▶ Do not use electrically conductive sealing compounds such as graphite.

Comply with the following instructions when installing seals:

1. Make sure that the seals do not protrude into the piping cross-section.
2. For DIN flanges: only use seals according to DIN EN 1514-1.
3. For "hard rubber" liner: additional seals are **always** required.
4. For "polyurethane" liner: generally additional seals are **not** required.

Mounting the ground cable/ground disks

Comply with the information on potential equalization and detailed mounting instructions for the use of ground cables/ground disks → 44.

Screw tightening torques

Please note the following:

- The screw tightening torques listed below apply only to lubricated threads and to pipes not subjected to tensile stress.
- Tighten the screws uniformly and in diagonally opposite sequence.
- Overtightening the screws will deform the sealing faces or damage the seals.

i Nominal screw tightening torques → 32

Maximum screw tightening torques

Maximum screw tightening torques for EN 1092-1 (DIN 2501)

Nominal diameter		Pressure rating [bar]	Screws [mm]	Flange thickness [mm]	Max. screw tightening torque [Nm]		
[mm]	[in]				HG	PUR	PTFE
25	1	PN 40	4 × M12	18	–	15	26
32	–	PN 40	4 × M16	18	–	24	41
40	1 ½	PN 40	4 × M16	18	–	31	52
50	2	PN 40	4 × M16	20	48	40	65
65 ¹⁾	–	PN 16	8 × M16	18	32	27	44
65	–	PN 40	8 × M16	22	32	27	44
80	3	PN 16	8 × M16	20	40	34	53
		PN 40	8 × M16	24	40	34	53

Nominal diameter		Pressure rating [bar]	Screws [mm]	Flange thickness [mm]	Max. screw tightening torque [Nm]		
[mm]	[in]				HG	PUR	PTFE
100	4	PN 16	8 × M16	20	43	36	57
		PN 40	8 × M20	24	59	50	79
125	-	PN 16	8 × M16	22	56	48	75
		PN 40	8 × M24	26	83	71	112
150	6	PN 16	8 × M20	22	74	63	99
		PN 40	8 × M24	28	104	88	137
200	8	PN 10	8 × M20	24	106	91	141
		PN 16	12 × M20	24	70	61	94
		PN 25	12 × M24	30	104	92	139
250	10	PN 10	12 × M20	26	82	71	110
		PN 16	12 × M24	26	98	85	132
		PN 25	12 × M27	32	150	134	201
300	12	PN 10	12 × M20	26	94	81	126
		PN 16	12 × M24	28	134	118	179
		PN 25	16 × M27	34	153	138	204
350	14	PN 6	12 × M20	22	111	120	-
		PN 10	16 × M20	26	112	118	-
		PN 16	16 × M24	30	152	165	-
		PN 25	16 × M30	38	227	252	-
400	16	PN 6	16 × M20	22	90	98	-
		PN 10	16 × M24	26	151	167	-
		PN 16	16 × M27	32	193	215	-
		PN 25	16 × M33	40	289	326	-
450	18	PN 6	16 × M20	22	112	126	-
		PN 10	20 × M24	28	153	133	-
		PN 16	20 × M27	40	198	196	-
		PN 25	20 × M33	46	256	253	-
500	20	PN 6	20 × M20	24	119	123	-
		PN 10	20 × M24	28	155	171	-
		PN 16	20 × M30	34	275	300	-
		PN 25	20 × M33	48	317	360	-
600	24	PN 6	20 × M24	30	139	147	-
		PN 10	20 × M27	28	206	219	-
600	24	PN 16	20 × M33	36	415	443	-
600	24	PN 25	20 × M36	58	431	516	-
700	28	PN 6	24 × M24	24	148	139	-
		PN 10	24 × M27	30	246	246	-
		PN 16	24 × M33	36	278	318	-
		PN 25	24 × M39	46	449	507	-
800	32	PN 6	24 × M27	24	206	182	-
		PN 10	24 × M30	32	331	316	-

Nominal diameter		Pressure rating	Screws	Flange thickness	Max. screw tightening torque [Nm]		
[mm]	[in]				[bar]	[mm]	HG
		PN 16	24 × M36	38	369	385	-
		PN 25	24 × M45	50	664	721	-
900	36	PN 6	24 × M27	26	230	637	-
		PN 10	28 × M30	34	316	307	-
		PN 16	28 × M36	40	353	398	-
		PN 25	28 × M45	54	690	716	-
1000	40	PN 6	28 × M27	26	218	208	-
		PN 10	28 × M33	34	402	405	-
		PN 16	28 × M39	42	502	518	-
		PN 25	28 × M52	58	970	971	-
1200	48	PN 6	32 × M30	28	319	299	-
		PN 10	32 × M36	38	564	568	-
		PN 16	32 × M45	48	701	753	-
1400	-	PN 6	36 × M33	32	430	-	-
		PN 10	36 × M39	42	654	-	-
		PN 16	36 × M45	52	729	-	-
1600	-	PN 6	40 × M33	34	440	-	-
		PN 10	40 × M45	46	946	-	-
		PN 16	40 × M52	58	1007	-	-
1800	72	PN 6	44 × M36	36	547	-	-
		PN 10	44 × M45	50	961	-	-
		PN 16	44 × M52	62	1108	-	-
2000	-	PN 6	48 × M39	38	629	-	-
		PN 10	48 × M45	54	1047	-	-
		PN 16	48 × M56	66	1324	-	-
2200	-	PN 6	52 × M39	42	698	-	-
		PN 10	52 × M52	58	1217	-	-
2400	-	PN 6	56 × M39	44	768	-	-
		PN 10	56 × M52	62	1229	-	-

1) Sizing as per EN 1092-1 (not DIN 2501)

Maximum screw tightening torques for ASME B16.5

Nominal diameter		Pressure rating	Screws	Max. screw tightening torque					
[mm]	[in]			[psi]	[in]	HG		PUR	
						[Nm]	[lbf · ft]	[Nm]	[lbf · ft]
25	1	Class 150	4 × ½	-	-	7	5		
25	1	Class 300	4 × 5/8	-	-	8	6		
40	1 ½	Class 150	4 × ½	-	-	10	7		
40	1 ½	Class 300	4 × ¾	-	-	15	11		
50	2	Class 150	4 × 5/8	35	26	22	16		

Nominal diameter		Pressure rating [psi]	Screws [in]	Max. screw tightening torque			
[mm]	[in]			HG		PUR	
				[Nm]	[lbf · ft]	[Nm]	[lbf · ft]
50	2	Class 300	8 × 5/8	18	13	11	8
80	3	Class 150	4 × 5/8	60	44	43	32
80	3	Class 300	8 × 3/4	38	28	26	19
100	4	Class 150	8 × 5/8	42	31	31	23
100	4	Class 300	8 × 3/4	58	43	40	30
150	6	Class 150	8 × 3/4	79	58	59	44
150	6	Class 300	12 × 3/4	70	52	51	38
200	8	Class 150	8 × 3/4	107	79	80	59
250	10	Class 150	12 × 7/8	101	74	75	55
300	12	Class 150	12 × 7/8	133	98	103	76
350	14	Class 150	12 × 1	135	100	158	117
400	16	Class 150	16 × 1	128	94	150	111
450	18	Class 150	16 × 1 1/8	204	150	234	173
500	20	Class 150	20 × 1 1/8	183	135	217	160
600	24	Class 150	20 × 1 1/4	268	198	307	226

Maximum screw tightening torques for JIS B2220

Nominal diameter [mm]	Pressure rating [bar]	Screws [mm]	Max. screw tightening torque [Nm]	
			HG	PUR
25	10K	4 × M16	–	19
25	20K	4 × M16	–	19
32	10K	4 × M16	–	22
32	20K	4 × M16	–	22
40	10K	4 × M16	–	24
40	20K	4 × M16	–	24
50	10K	4 × M16	40	33
50	20K	8 × M16	20	17
65	10K	4 × M16	55	45
65	20K	8 × M16	28	23
80	10K	8 × M16	29	23
80	20K	8 × M20	42	35
100	10K	8 × M16	35	29
100	20K	8 × M20	56	48
125	10K	8 × M20	60	51
125	20K	8 × M22	91	79
150	10K	8 × M20	75	63
150	20K	12 × M22	81	72
200	10K	12 × M20	61	52
200	20K	12 × M22	91	80
250	10K	12 × M22	100	87

Nominal diameter [mm]	Pressure rating [bar]	Screws [mm]	Max. screw tightening torque [Nm]	
			HG	PUR
250	20K	12 × M24	159	144
300	10K	16 × M22	74	63
300	20K	16 × M24	138	124

Maximum screw tightening torques for AWWA C207, Class D

Nominal diameter		Screws [in]	Max. screw tightening torque			
[mm]	[in]		HG		PUR	
			[Nm]	[lbf · ft]	[Nm]	[lbf · ft]
700	28	28 × 1 ¼	247	182	292	215
750	30	28 × 1 ¼	287	212	302	223
800	32	28 × 1 ½	394	291	422	311
900	36	32 × 1 ½	419	309	430	317
1000	40	36 × 1 ½	420	310	477	352
–	42	36 × 1 ½	528	389	518	382
–	48	44 × 1 ½	552	407	531	392
–	54	44 × 1 ¾	730	538	–	–
–	60	52 × 1 ¾	758	559	–	–
–	66	52 × 1 ¾	946	698	–	–
–	72	60 × 1 ¾	975	719	–	–
–	78	64 × 2	853	629	–	–
–	84	64 × 2	931	687	–	–
–	90	64 × 2 ¼	1048	773	–	–

Maximum screw tightening torques for AS 2129, Table E

Nominal diameter [mm]	Screws [mm]	Max. screw tightening torque [Nm]	
		HG	PUR
50	4 × M16	32	–
80	4 × M16	49	–
100	8 × M16	38	–
150	8 × M20	64	–
200	8 × M20	96	–
250	12 × M20	98	–
300	12 × M24	123	–
350	12 × M24	203	–
400	12 × M24	226	–
450	16 × M24	226	–
500	16 × M24	271	–
600	16 × M30	439	–
700	20 × M30	355	–
750	20 × M30	559	–

Nominal diameter [mm]	Screws [mm]	Max. screw tightening torque [Nm]	
		HG	PUR
800	20 × M30	631	-
900	24 × M30	627	-
1000	24 × M30	634	-
1200	32 × M30	727	-

Maximum screw tightening torques for AS 4087, PN 16

Nominal diameter [mm]	Screws [mm]	Max. screw tightening torque [Nm]	
		HG	PUR
50	4 × M16	32	-
80	4 × M16	49	-
100	4 × M16	76	-
150	8 × M20	52	-
200	8 × M20	77	-
250	8 × M20	147	-
300	12 × M24	103	-
350	12 × M24	203	-
375	12 × M24	137	-
400	12 × M24	226	-
450	12 × M24	301	-
500	16 × M24	271	-
600	16 × M27	393	-
700	20 × M27	330	-
750	20 × M30	529	-
800	20 × M33	631	-
900	24 × M33	627	-
1000	24 × M33	595	-
1200	32 × M33	703	-

Nominal screw tightening torques

Nominal screw tightening torques for EN 1092-1 (DIN 2501); calculated according to EN 1591-1:2014 for flanges according to EN 1092-1:2013

Nominal diameter		Pressure rating [bar]	Screws [mm]	Flange thickness [mm]	Nom. screw tightening torque [Nm]		
[mm]	[in]				HG	PUR	PTFE
1000	40	PN 6	28 × M27	38	175	185	-
		PN 10	28 × M33	44	350	360	-
		PN 16	28 × M39	59	630	620	-
		PN 25	28 × M52	63	1300	1290	-
1200	48	PN 6	32 × M30	42	235	250	-
		PN 10	32 × M36	55	470	480	-
		PN 16	32 × M45	78	890	900	-

Nominal diameter		Pressure rating [bar]	Screws [mm]	Flange thickness [mm]	Nom. screw tightening torque [Nm]		
[mm]	[in]				HG	PUR	PTFE
1400	-	PN 6	36 × M33	56	300	-	-
		PN 10	36 × M39	65	600	-	-
		PN 16	36 × M45	84	1050	-	-
1600	-	PN 6	40 × M33	63	340	-	-
		PN 10	40 × M45	75	810	-	-
		PN 16	40 × M52	102	1420	-	-
1800	72	PN 6	44 × M36	69	430	-	-
		PN 10	44 × M45	85	920	-	-
		PN 16	44 × M52	110	1600	-	-
2000	-	PN 6	48 × M39	74	530	-	-
		PN 10	48 × M45	90	1040	-	-
		PN 16	48 × M56	124	1900	-	-
2200	-	PN 6	52 × M39	81	580	-	-
		PN 10	52 × M52	100	1290	-	-
2400	-	PN 6	56 × M39	87	650	-	-
		PN 10	56 × M52	110	1410	-	-

Nominal screw tightening torques for JIS B2220

Nominal diameter [mm]	Pressure rating [bar]	Screws [mm]	Nom. screw tightening torque [Nm]	
			HG	PUR
350	10K	16 × M22	109	109
	20K	16 × M30×3	217	217
400	10K	16 × M24	163	163
	20K	16 × M30×3	258	258
450	10K	16 × M24	155	155
	20K	16 × M30×3	272	272
500	10K	16 × M24	183	183
	20K	16 × M30×3	315	315
600	10K	16 × M30	235	235
	20K	16 × M36×3	381	381
700	10K	16 × M30	300	300
750	10K	16 × M30	339	339

6.2.4 Turning the transmitter housing

To provide easier access to the connection compartment or display module, the transmitter housing can be turned.

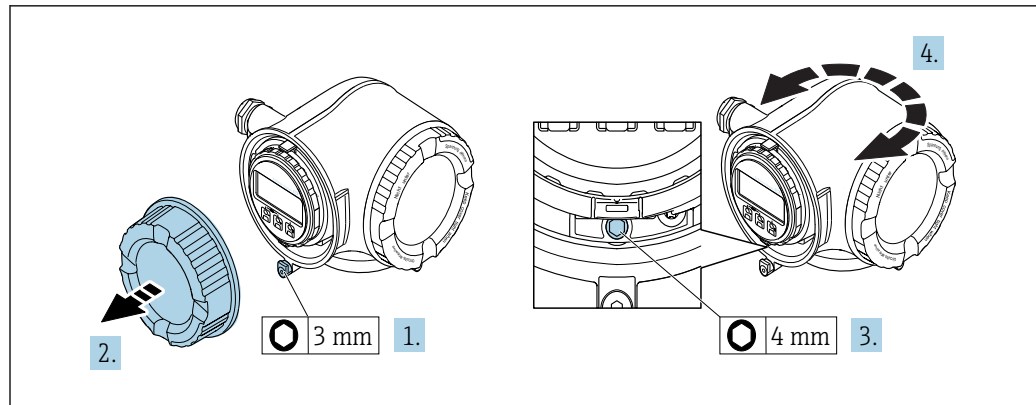

A0029993

1. Depending on the device version: Loosen the securing clamp of the connection compartment cover.
2. Unscrew the connection compartment cover.
3. Release the fixing screw.
4. Turn the housing to the desired position.
5. Firmly tighten the securing screw.
6. Screw on the connection compartment cover
7. Depending on the device version: Attach the securing clamp of the connection compartment cover.

6.2.5 Turning the display module

The display module can be turned to optimize display readability and operability.

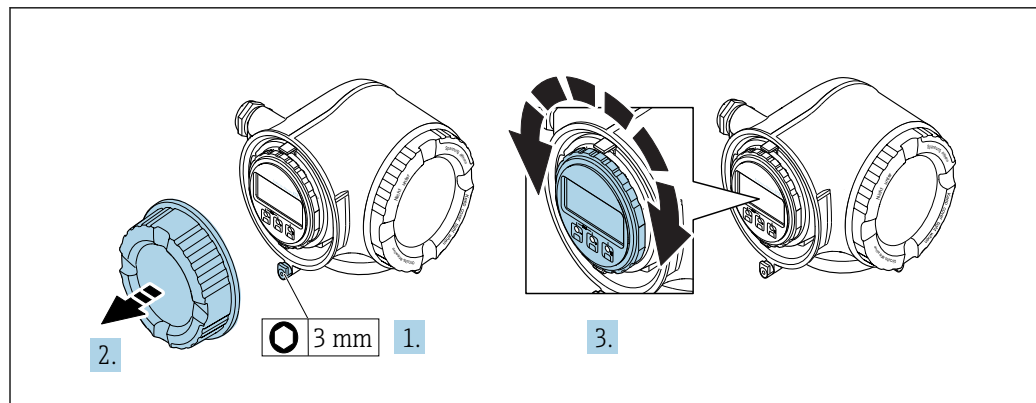

A0030035

1. Depending on the device version: Loosen the securing clamp of the connection compartment cover.
2. Unscrew the connection compartment cover.
3. Turn the display module to the desired position: max. $8 \times 45^\circ$ in each direction.
4. Screw on the connection compartment cover.
5. Depending on the device version: Attach the securing clamp of the connection compartment cover.

6.3 Post-installation check

Is the device undamaged (visual inspection)?	<input type="checkbox"/>
Does the measuring device conform to the measuring point specifications? For example: <ul style="list-style-type: none"> ▪ Process temperature ▪ Process pressure (refer to the section on "Pressure-temperature ratings" in the "Technical Information" document) ▪ Ambient temperature ▪ Measuring range 	<input type="checkbox"/>
Has the correct orientation for the sensor been selected ? <ul style="list-style-type: none"> ▪ According to sensor type ▪ According to medium temperature ▪ According to medium properties (outgassing, with entrained solids) 	<input type="checkbox"/>
Does the arrow on the sensor nameplate match the direction of flow of the fluid through the piping ?	<input type="checkbox"/>
Are the measuring point identification and labeling correct (visual inspection)?	<input type="checkbox"/>
Is the device adequately protected from precipitation and direct sunlight?	<input type="checkbox"/>
Have the fixing screws been tightened with the correct tightening torque?	<input type="checkbox"/>

7 Electrical connection

NOTICE

The measuring device does not have an internal circuit breaker.

- ▶ For this reason, assign the measuring device a switch or power-circuit breaker so that the power supply line can be easily disconnected from the mains.
- ▶ Although the measuring device is equipped with a fuse, additional overcurrent protection (maximum 10 A) should be integrated into the system installation.

7.1 Connection conditions

7.1.1 Required tools

- For cable entries: Use corresponding tools
- For securing clamp: Allen key 3 mm
- Wire stripper
- When using stranded cables: Crimper for wire end ferrule
- For removing cables from terminal: Flat blade screwdriver ≤ 3 mm (0.12 in)

7.1.2 Requirements for connecting cable

The connecting cables provided by the customer must fulfill the following requirements.

Electrical safety

In accordance with applicable federal/national regulations.

Protective ground cable

Cable ≥ 2.08 mm² (14 AWG)

The grounding impedance must be less than 1 Ω .

Permitted temperature range

- The installation guidelines that apply in the country of installation must be observed.
- The cables must be suitable for the minimum and maximum temperatures to be expected.

Power supply cable

Standard installation cable is sufficient.

Signal cable

PROFIBUS PA

Twisted, shielded two-wire cable. Cable type A is recommended .



For further information on planning and installing PROFIBUS networks see:

- Operating Instructions "PROFIBUS DP/PA: Guidelines for planning and commissioning" (BA00034S)
- PNO Directive 2.092 "PROFIBUS PA User and Installation Guideline"
- IEC 61158-2 (MBP)

Current output 0/4 to 20 mA

Standard installation cable is sufficient.

Pulse/frequency/switch output

Standard installation cable is sufficient.

Relay output

Standard installation cable is sufficient.

Current input 0/4 to 20 mA

Standard installation cable is sufficient.

Status input

Standard installation cable is sufficient.

Cable diameter

- Cable glands supplied:
M20 × 1.5 with cable \varnothing 6 to 12 mm (0.24 to 0.47 in)
- Spring-loaded terminals: Suitable for strands and strands with ferrules.
Conductor cross-section 0.2 to 2.5 mm² (24 to 12 AWG).

Requirements for the connecting cable – Remote display and operating module DKX001*Optionally available connecting cable*

A cable is supplied depending on the order option

- Order code for measuring device: order code **030** for "Display; operation", option **O** or
- Order code for measuring device: order code **030** for "Display; operation", option **M** and
- Order code for DKX001: order code **040** for "Cable", option **A, B, D, E**

Standard cable	2 × 2 × 0.34 mm ² (22 AWG) PVC cable with common shield (2 pairs, pair-stranded)
Flame resistance	According to DIN EN 60332-1-2
Oil-resistance	According to DIN EN 60811-2-1
Shielding	Tin-plated copper-braid, optical cover ≥ 85 %
Capacitance: core/shield	≤200 pF/m
L/R	≤24 μH/Ω
Available cable length	5 m (15 ft)/10 m (35 ft)/20 m (65 ft)/30 m (100 ft)
Operating temperature	When mounted in a fixed position: -50 to +105 °C (-58 to +221 °F); when cable can move freely: -25 to +105 °C (-13 to +221 °F)

Standard cable - customer-specific cable

No cable is supplied, and it must be provided by the customer (up to max. 300 m (1 000 ft)) for the following order option:

Order code for DKX001: Order code **040** for "Cable", option **1** "None, provided by customer, max 300 m"

A standard cable can be used as the connecting cable.

Standard cable	4 cores (2 pairs); pair-stranded with common shield
Shielding	Tin-plated copper-braid, optical cover ≥ 85 %
Capacitance: core/shield	Maximum 1 000 nF for Zone 1, Class I, Division 1

L/R	Maximum 24 $\mu\text{H}/\Omega$ for Zone 1, Class I, Division 1
Cable length	Maximum 300 m (1000 ft), see the following table



Cross-section	Max. cable length for use in Non-hazardous area, Ex Zone 2, Class I, Division 2 Ex Zone 1, Class I, Division 1
0.34 mm ² (22 AWG)	80 m (270 ft)
0.50 mm ² (20 AWG)	120 m (400 ft)
0.75 mm ² (18 AWG)	180 m (600 ft)
1.00 mm ² (17 AWG)	240 m (800 ft)
1.50 mm ² (15 AWG)	300 m (1000 ft)

7.1.3 Terminal assignment

Transmitter: supply voltage, input/outputs

The terminal assignment of the inputs and outputs depends on the individual order version of the device. The device-specific terminal assignment is documented on an adhesive label in the terminal cover.

Supply voltage		Input/output 1		Input/output 2		Input/output 3	
1 (+)	2 (-)	26 (B)	27 (A)	24 (+)	25 (-)	22 (+)	23 (-)
Device-specific terminal assignment: adhesive label in terminal cover.							

 Terminal assignment of the remote display and operating module →  44.

7.1.4 Device plugs available

 Device plugs may not be used in hazardous areas!

Order code for "Input; output 1", option GA "PROFIBUS PA"

Order code for "Electrical connection"	Cable entry/connection	
	2	3
L, N, P, U	Connector M12 × 1	-

7.1.5 Pin assignment of device plug

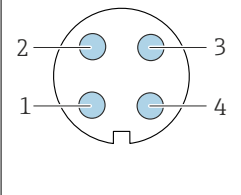
	Pin	Assignment	Coding A	Plug/socket Plug	
	1	+			PROFIBUS PA +
	2				Grounding
	3	-			PROFIBUS PA -
	4				Not assigned

7.1.6 Shielding and grounding

Optimal electromagnetic compatibility (EMC) of the fieldbus system can be guaranteed only if the system components and, in particular, the lines are shielded and the shield forms as complete a cover as possible. A shield coverage of 90 % is ideal.

1. To ensure optimal EMC protection, connect the shield to the reference ground as often as possible.
2. For reasons concerning explosion protection, it is recommended that grounding be dispensed with.

To comply with both requirements, there are basically three different types of shielding in the fieldbus system:

- Shielding at both ends
- Shielding at one end on the feed side with capacitance termination at the field device
- Shielding at one end on the feed side

Experience shows that the best results with regard to EMC are achieved in most cases in installations with one-sided shielding on the feed side (without capacitance termination at the field device). Appropriate measures with regard to input wiring must be taken to allow

unrestricted operation when EMC interference is present. These measures have been taken into account for this device. Operation in the event of disturbance variables as per NAMUR NE21 is thus guaranteed.

1. Observe national installation requirements and guidelines during installation.
2. Where there are large differences in potential between the individual grounding points, connect only one point of the shielding directly to the reference ground.
3. In systems without potential equalization, the cable shielding of fieldbus systems should be grounded on one side only, for example at the fieldbus supply unit or at safety barriers.

NOTICE

In systems without potential matching, the multiple grounding of the cable shield causes mains frequency equalizing currents!

Damage to the bus cable shield.

- ▶ Only ground the bus cable shield to either the local ground or the protective ground at one end.
- ▶ Insulate the shield that is not connected.

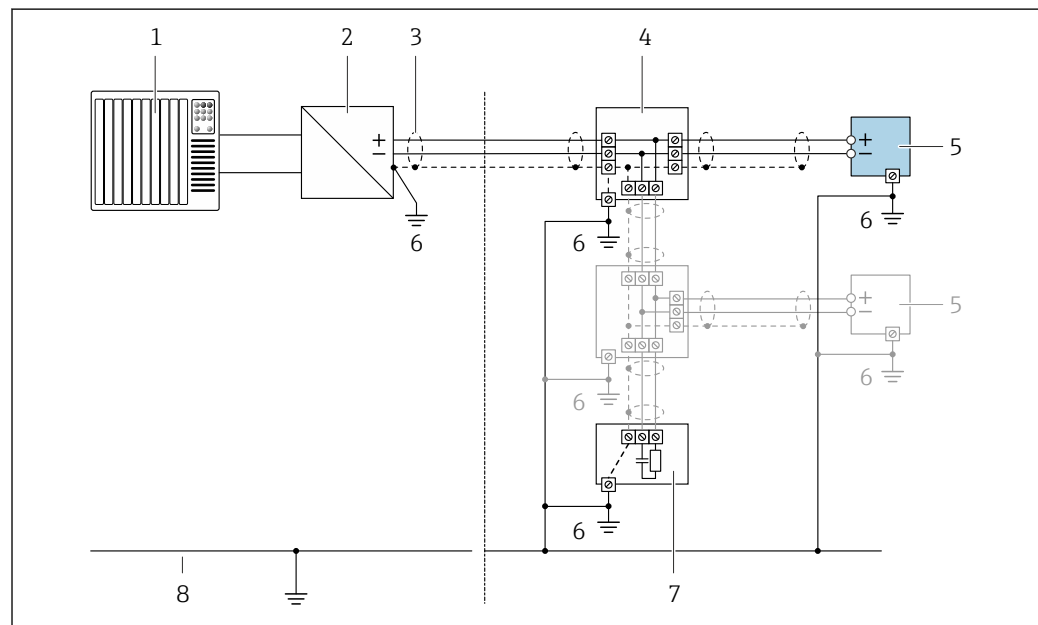

7 Connection example for PROFIBUS PA

- 1 Control system (e.g. PLC)
- 2 PROFIBUS PA segment coupler
- 3 Cable shield: the cable shield must be grounded at both ends to comply with EMC requirements; observe cable specifications
- 4 T-box
- 5 Measuring device
- 6 Local grounding
- 7 Bus terminator
- 8 Potential equalization conductor

7.1.7 Preparing the measuring device

NOTICE

Insufficient sealing of the housing!

Operational reliability of the measuring device could be compromised.

- ▶ Use suitable cable glands corresponding to the degree of protection.

1. Remove dummy plug if present.

2. If the measuring device is supplied without cable glands:
Provide suitable cable gland for corresponding connecting cable.
3. If the measuring device is supplied with cable glands:
Observe requirements for connecting cables → 36.

7.2 Connecting the measuring device

NOTICE

Limitation of electrical safety due to incorrect connection!

- ▶ Have electrical connection work carried out by appropriately trained specialists only.
- ▶ Observe applicable federal/national installation codes and regulations.
- ▶ Comply with local workplace safety regulations.
- ▶ Always connect the protective ground cable ⊕ before connecting additional cables.
- ▶ For use in potentially explosive atmospheres, observe the information in the device-specific Ex documentation.

7.2.1 Connecting the transmitter

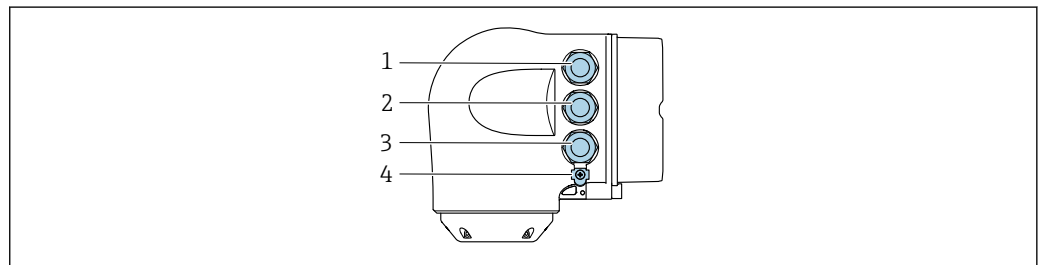

A0026781

- 1 Terminal connection for supply voltage
- 2 Terminal connection for signal transmission, input/output
- 3 Terminal connection for signal transmission, input/output or terminal connection for network connection via service interface (CDI-RJ45); optional: connection for external WLAN antenna or remote display and operating module DKX001
- 4 Protective earth (PE)

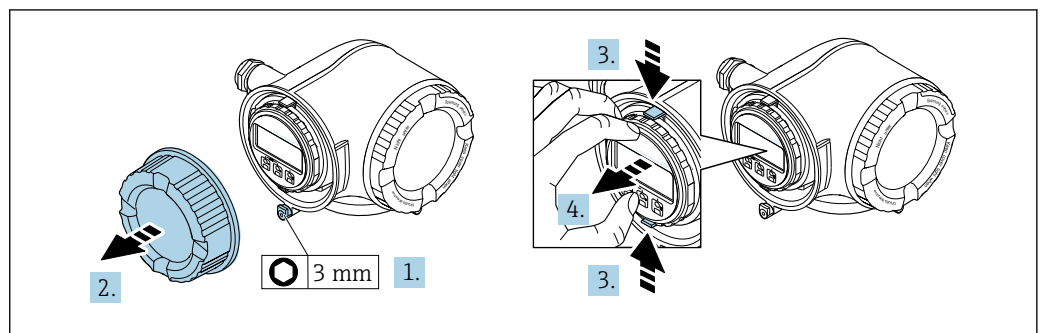

A0029813

1. Loosen the securing clamp of the connection compartment cover.
2. Unscrew the connection compartment cover.
3. Squeeze the tabs of the display module holder together.
4. Remove the display module holder.

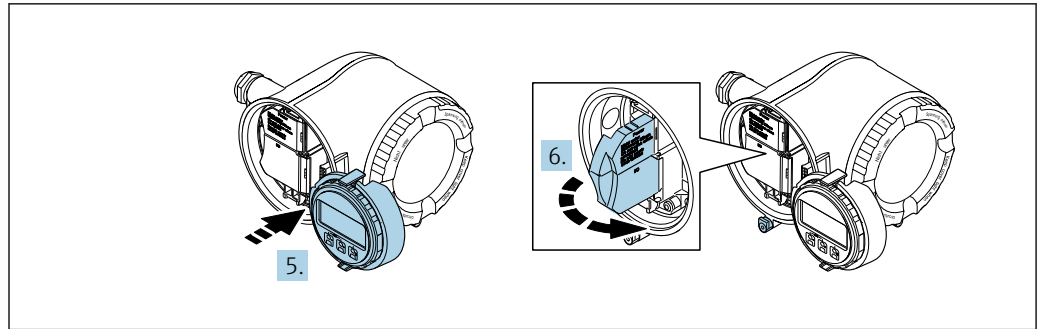

A0029814

5. Attach the holder to the edge of the electronics compartment.
6. Open the terminal cover.

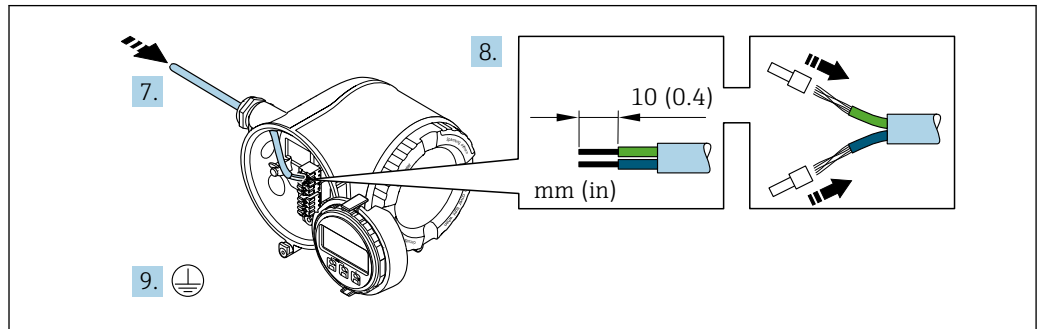

A0029815

7. Push the cable through the cable entry . To ensure tight sealing, do not remove the sealing ring from the cable entry.
8. Strip the cable and cable ends. In the case of stranded cables, also fit ferrules.
9. Connect the protective ground.

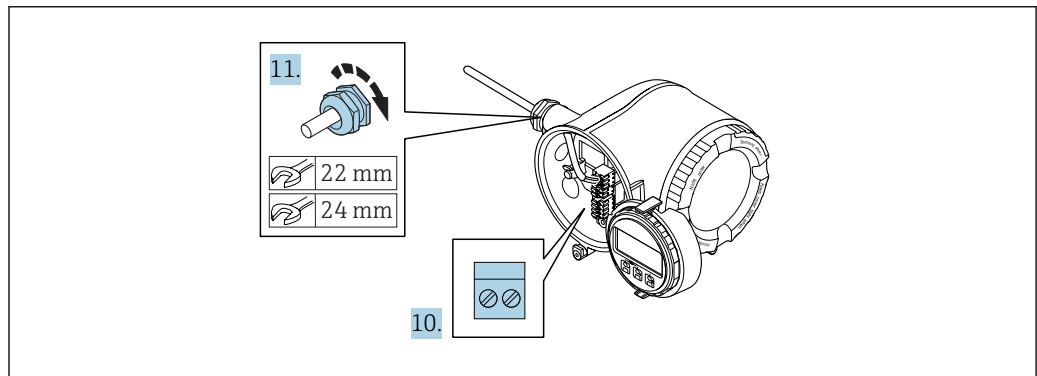

A0029816

10. Connect the cable in accordance with the terminal assignment .
 - ↳ **Signal cable terminal assignment:** The device-specific terminal assignment is documented on an adhesive label in the terminal cover.
 - Supply voltage terminal assignment:** Adhesive label in the terminal cover or → 39.
11. Firmly tighten the cable glands.
 - ↳ This concludes the cable connection process.
12. Close the terminal cover.
13. Fit the display module holder in the electronics compartment.
14. Screw on the connection compartment cover.
15. Secure the securing clamp of the connection compartment cover.

Removing a cable

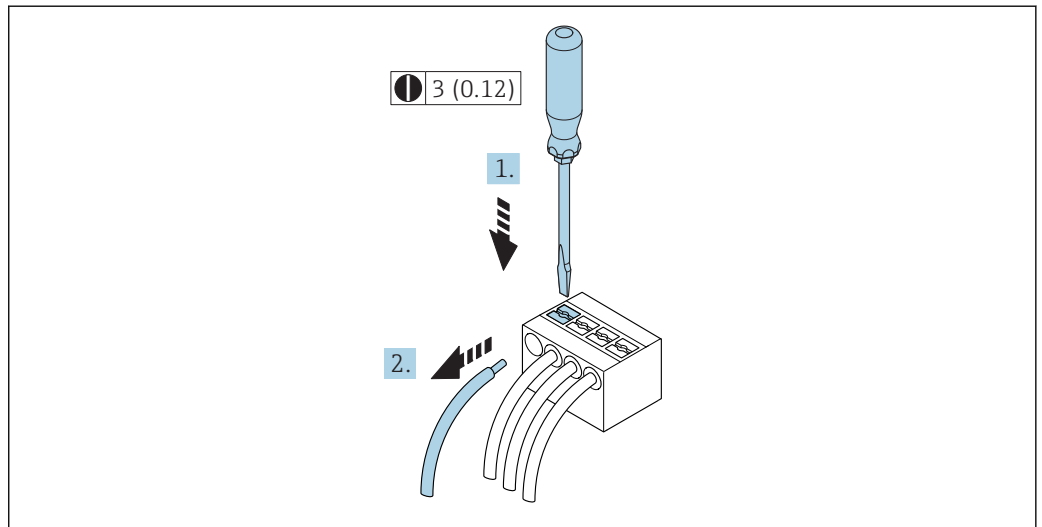

8 Engineering unit mm (in)

A0029598

1. To remove a cable from the terminal, use a flat-blade screwdriver to push the slot between the two terminal holes
2. while simultaneously pulling the cable end out of the terminal.

7.2.2 Connecting the remote display and operating module DKX001

i The remote display and operating module DKX001 is available as an optional extra
→ 184.

- The measuring device is always supplied with a dummy cover when the remote display and operating module DKX001 is ordered directly with the measuring device. Display or operation at the transmitter is not possible in this case.
- If ordered subsequently, the remote display and operating module DKX001 may not be connected at the same time as the existing measuring device display module. Only one display or operation unit may be connected to the transmitter at any one time.

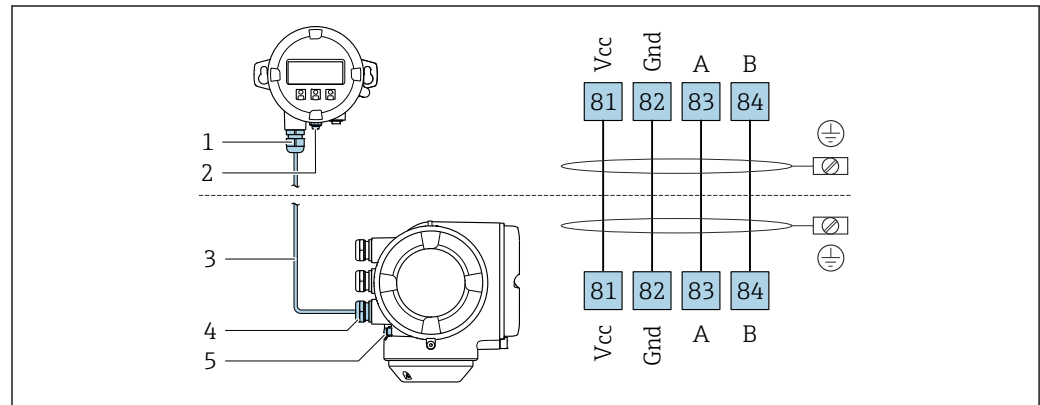

- 1 Remote display and operating module DKX001
- 2 Protective earth (PE)
- 3 Connecting cable
- 4 Measuring device
- 5 Protective earth (PE)

A0027518

7.3 Ensuring potential equalization

7.3.1 Requirements

CAUTION

Electrode damage can result in the complete failure of the device!

- ▶ Same electrical potential for the fluid and sensor
- ▶ Company-internal grounding concepts
- ▶ Pipe material and grounding

7.3.2 Connection example, standard scenario

Metal, grounded pipe

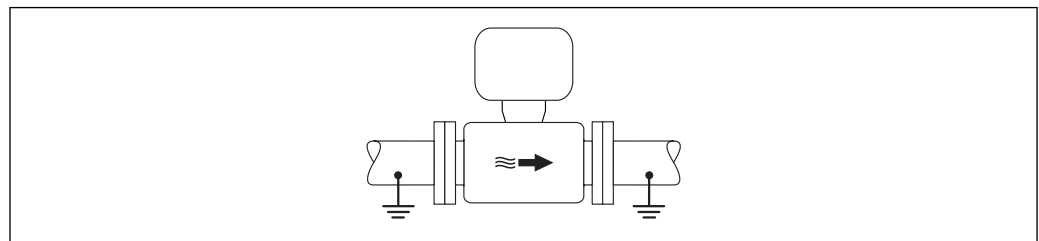

9 Potential equalization via measuring tube

A0016315

7.3.3 Connection example in special situations

Unlined and ungrounded metal pipe

This connection method also applies in situations where:

- The customary potential equalization is not used
- Equalizing currents are present

Ground cable	Copper wire, at least 6 mm ² (0.0093 in ²)
---------------------	---

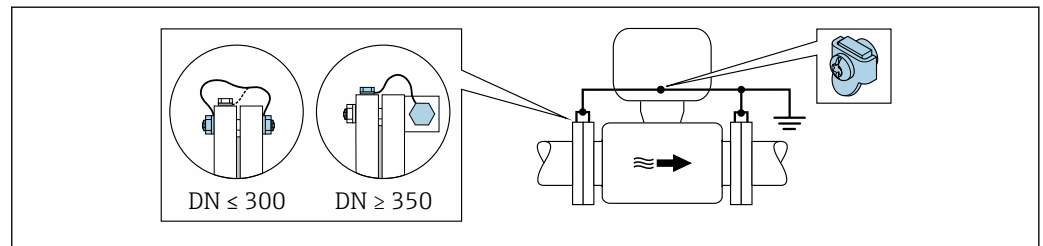

10 Potential equalization via ground terminal and pipe flanges

1. Connect both sensor flanges to the pipe flange via a ground cable and ground them.
2. If $DN \leq 300$ (12"): Mount the ground cable directly on the conductive flange coating of the sensor with the flange screws.
3. If $DN \geq 350$ (14"): Mount the ground cable directly on the metal transport bracket. Observe screw tightening torques: see the Sensor Brief Operating Instructions.
4. Connect the connection housing of the transmitter or sensor to ground potential by means of the ground terminal provided for the purpose.

Plastic pipe or pipe with insulating liner

This connection method also applies in situations where:

- The customary potential equalization is not used
- Equalizing currents are present

Ground cable	Copper wire, at least 6 mm ² (0.0093 in ²)
---------------------	---

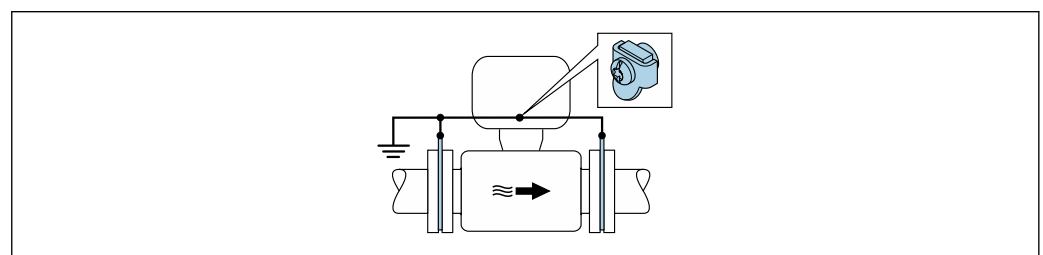

11 Potential equalization via ground terminal and ground disks

1. Connect the ground disks to the ground terminal via the ground cable.
2. Connect the ground disks to ground potential.

Pipe with a cathodic protection unit

This connection method is only used if the following two conditions are met:

- Metal pipe without liner or pipe with electrically conductive liner
- Cathodic protection is integrated in the personal protection equipment

Ground cable	Copper wire, at least 6 mm ² (0.0093 in ²)
---------------------	---

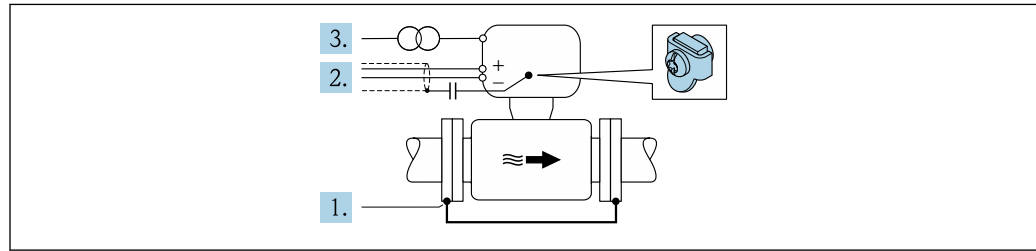

A0029340

Prerequisite: The sensor is installed in the pipe in a way that provides electrical insulation.

1. Connect the two flanges of the pipe to one another via a ground cable.
2. Guide the shield of the signal lines through a capacitor.
3. Connect the measuring device to the power supply such that it is floating in relation to the protective ground (isolation transformer).

7.4 Special connection instructions

7.4.1 Connection examples

PROFIBUS PA

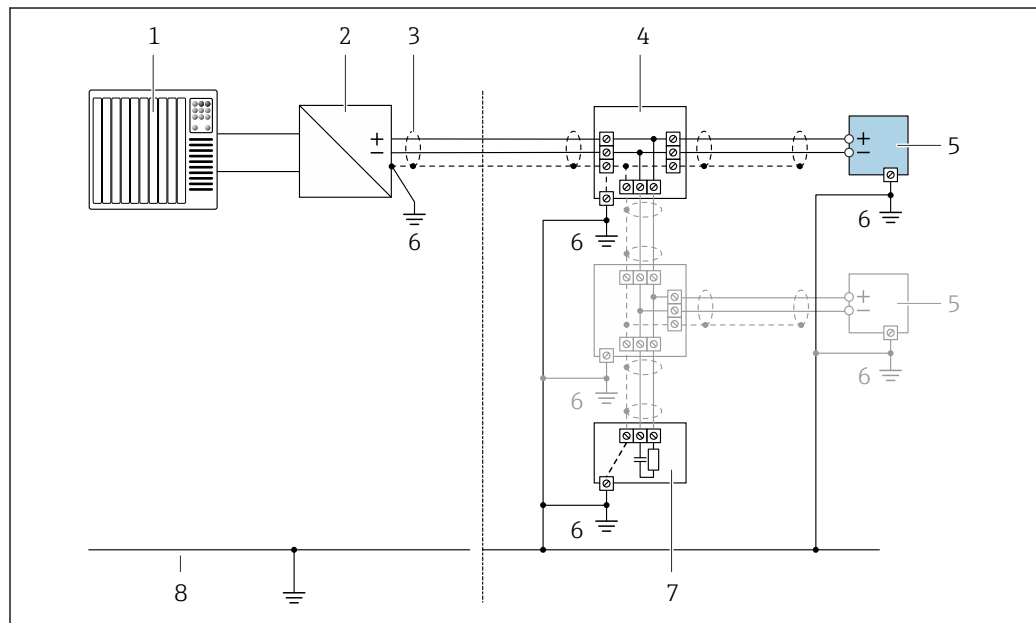

A0028768

12 Connection example for PROFIBUS PA

- 1 Control system (e.g. PLC)
- 2 PROFIBUS PA segment coupler
- 3 Cable shield provided at one end. The cable shield must be grounded at both ends to comply with EMC requirements; observe cable specifications
- 4 T-box
- 5 Measuring device
- 6 Local grounding
- 7 Bus terminator
- 8 Potential matching line

Current output 4-20 mA

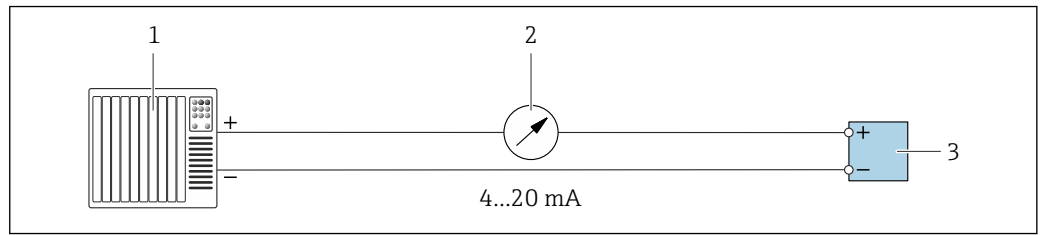

A0028758

13 Connection example for 4-20 mA current output (active)

- 1 Automation system with current input (e.g. PLC)
- 2 Analog display unit: observe maximum load
- 3 Transmitter

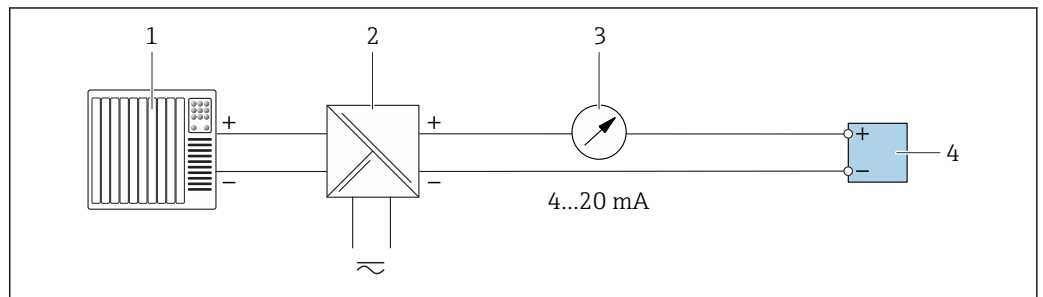

A0028759

14 Connection example for 4-20 mA current output (passive)

- 1 Automation system with current input (e.g. PLC)
- 2 Active barrier for power supply (e.g. RN221N)
- 3 Analog display unit: observe maximum load
- 4 Transmitter

Pulse/frequency output

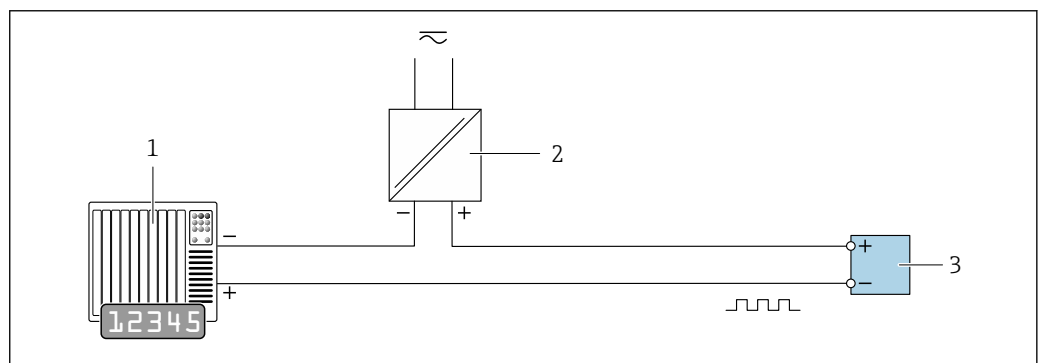

A0028761

15 Connection example for pulse/frequency output (passive)

- 1 Automation system with pulse/frequency input (e.g. PLC)
- 2 Power supply
- 3 Transmitter: Observe input values → 193

Switch output

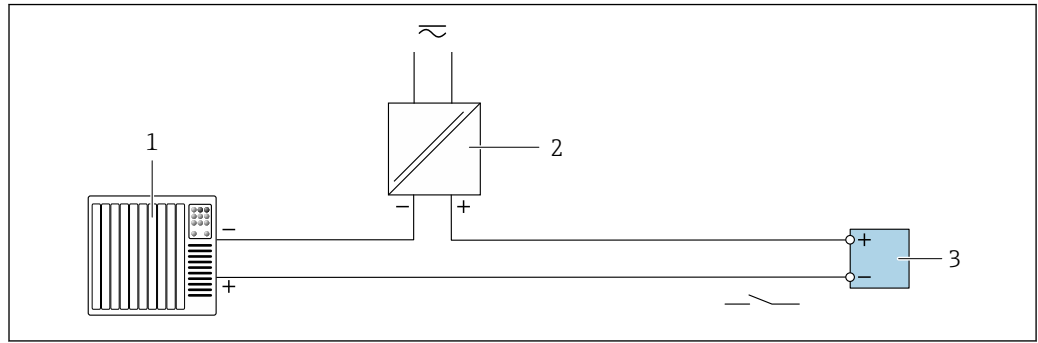

A0028760

16 Connection example for switch output (passive)

- 1 Automation system with switch input (e.g. PLC)
- 2 Power supply
- 3 Transmitter: Observe input values → 193

Relay output

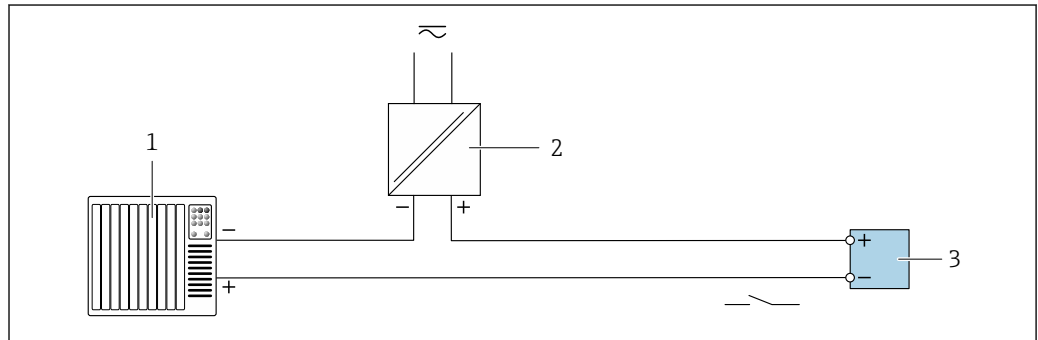

A0028760

17 Connection example for relay output (passive)

- 1 Automation system with relay input (e.g. PLC)
- 2 Power supply
- 3 Transmitter: Observe input values → 194

Current input

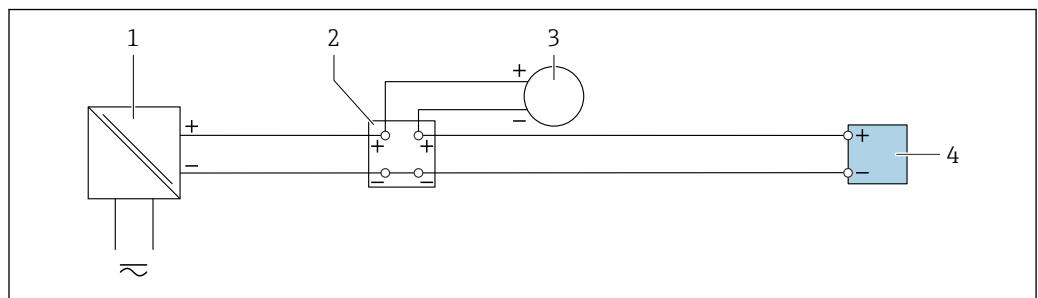

A0028915

18 Connection example for 4 to 20 mA current input

- 1 Power supply
- 2 Terminal box
- 3 External measuring device (to read in pressure or temperature, for instance)
- 4 Transmitter

Status input

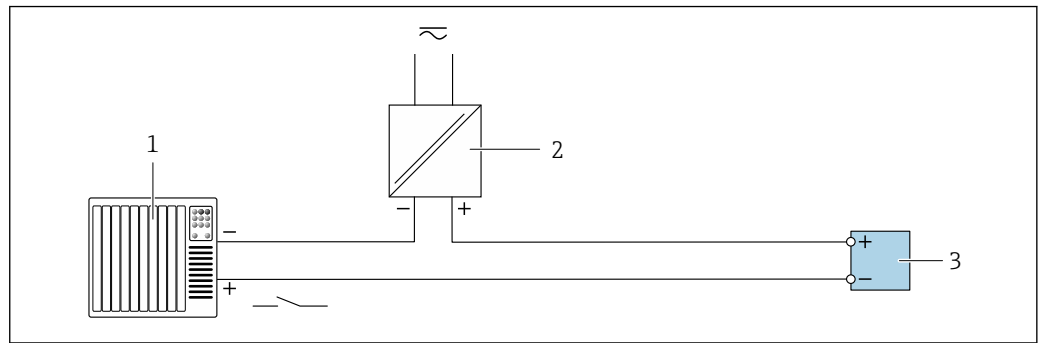

A0028764

19 Connection example for status input

- 1 Automation system with status output (e.g. PLC)
- 2 Power supply
- 3 Transmitter

7.5 Hardware settings

7.5.1 Setting the device address

The address must always be configured for a PROFIBUS DP/PA device. The valid address range is between 1 and 126. In a PROFIBUS DP/PA network, each address can only be assigned once. If an address is not configured correctly, the device is not recognized by the master. All measuring devices are delivered from the factory with the device address 126 and with the software addressing method.

Risk of electric shock when opening the transmitter housing.

- ▶ Before opening the transmitter housing:
- ▶ Disconnect the device from the power supply.

Hardware addressing

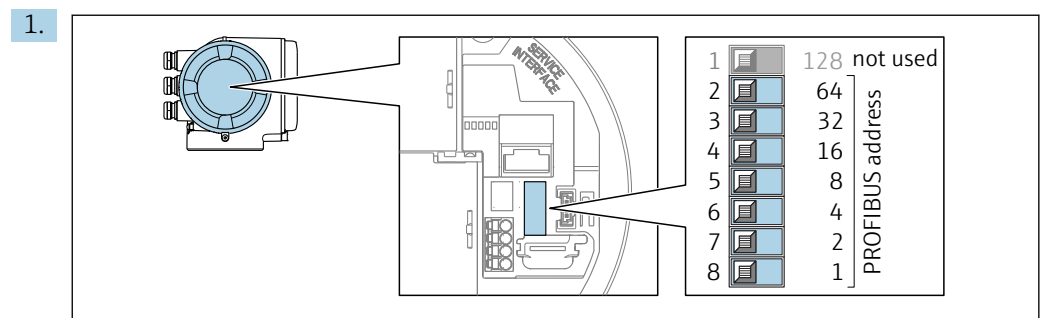

A0029637

Set the desired device address using the DIP switches in the connection compartment.

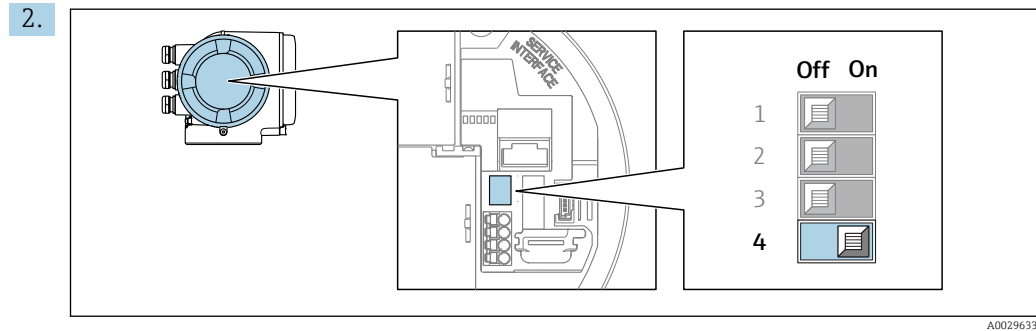

To switch addressing from software addressing to hardware addressing: set the DIP switch to **On**.

↳ The change of device address takes effect after 10 seconds. The device is restarted.

Software addressing

► To switch addressing from hardware addressing to software addressing: set DIP switch No. 4 to **Off**.

↳ The device address configured in the **Device address** parameter (→ 94) takes effect after 10 seconds. The device is restarted.

7.5.2 Activating the default IP address

The default IP address 192.168.1.212 can be activated by DIP switch.

Activating the default IP address by DIP switch

Risk of electric shock when opening the transmitter housing.

- Before opening the transmitter housing:
- Disconnect the device from the power supply.

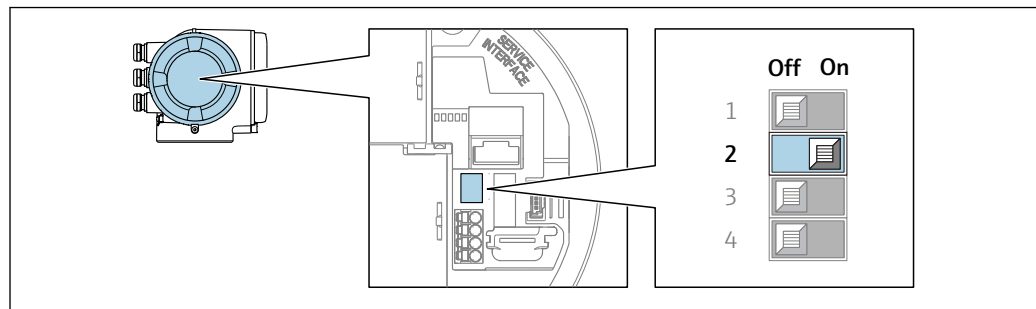

1. Depending on the housing version, loosen the securing clamp or fixing screw of the housing cover.
2. Depending on the housing version, unscrew or open the housing cover and disconnect the local display from the main electronics module where necessary .
3. Set DIP switch No. 2 on the I/O electronics module from **OFF** → **ON**.
4. Reverse the removal procedure to reassemble the transmitter.
5. Reconnect the device to the power supply.
 - ↳ The default IP address is used once the device is restarted.

7.6 Ensuring the degree of protection

The measuring device fulfills all the requirements for the IP66/67 degree of protection, Type 4X enclosure.

To guarantee IP66/67 degree of protection, Type 4X enclosure, carry out the following steps after the electrical connection:

1. Check that the housing seals are clean and fitted correctly.
2. Dry, clean or replace the seals if necessary.
3. Tighten all housing screws and screw covers.
4. Firmly tighten the cable glands.
5. To ensure that moisture does not enter the cable entry:
Route the cable so that it loops down before the cable entry ("water trap").

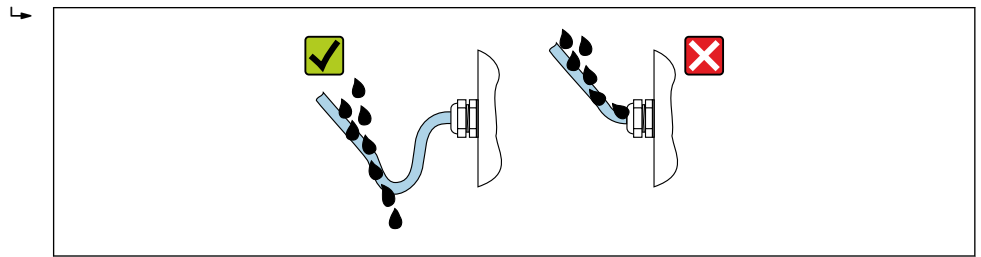

6. Insert dummy plugs into unused cable entries.

7.7 Post-connection check

Are cables or the device undamaged (visual inspection)?	<input type="checkbox"/>
Do the cables used meet the requirements?	<input type="checkbox"/>
Do the cables have adequate strain relief?	<input type="checkbox"/>
Are all the cable glands installed, firmly tightened and leak-tight? Cable run with "water trap" → 50?	<input type="checkbox"/>
If supply voltage is present, do values appear on the display module?	<input type="checkbox"/>
Is the potential equalization established correctly ?	<input type="checkbox"/>

8 Operation options

8.1 Overview of operation options

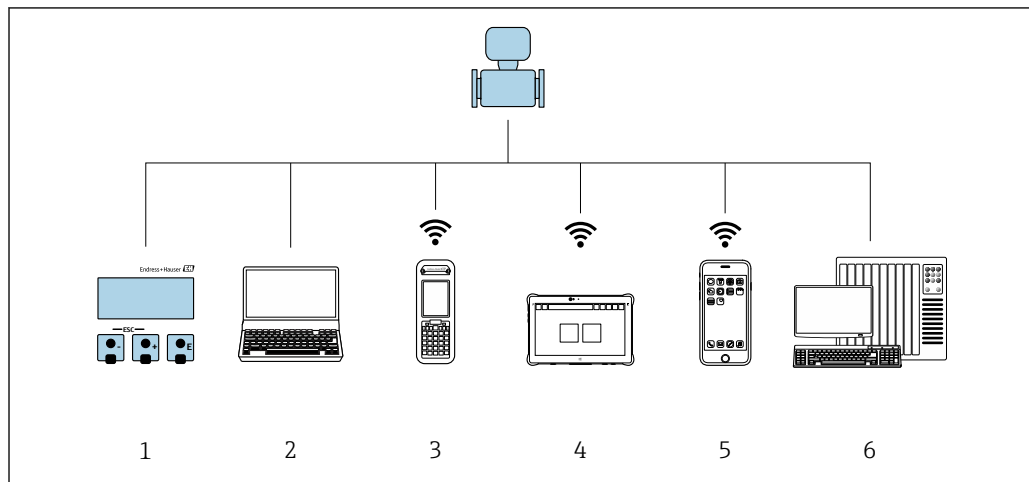



A0034513

- 1 Local operation via display module
- 2 Computer with Web browser (e.g. Internet Explorer) or with operating tool (e.g. FieldCare, DeviceCare, AMS Device Manager, SIMATIC PDM)
- 3 Field Xpert SFX350 or SFX370
- 4 Field Xpert SMT70
- 5 Mobile handheld terminal
- 6 Control system (e.g. PLC)

8.2 Structure and function of the operating menu

8.2.1 Structure of the operating menu

 For an overview of the operating menu for experts: "Description of Device Parameters" document supplied with the device →  220

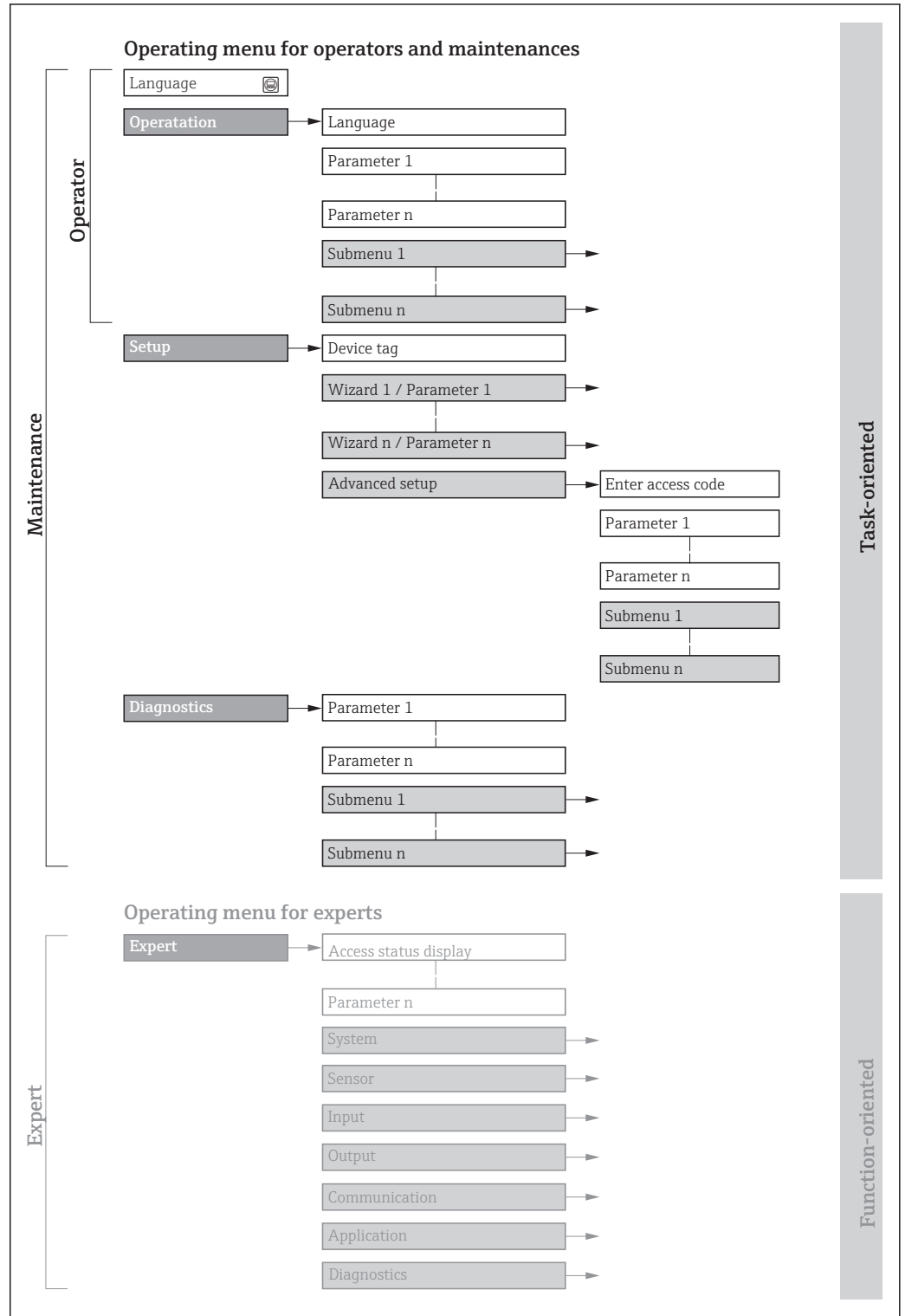

 20 Schematic structure of the operating menu

A0018237-EN

8.2.2 Operating philosophy

The individual parts of the operating menu are assigned to certain user roles (operator, maintenance etc.). Each user role contains typical tasks within the device lifecycle.

Menu/parameter		User role and tasks	Content/meaning
Language	task-oriented	Role "Operator", "Maintenance" Tasks during operation: <ul style="list-style-type: none"> ▪ Configuring the operational display ▪ Reading measured values 	<ul style="list-style-type: none"> ▪ Defining the operating language ▪ Defining the Web server operating language ▪ Resetting and controlling totalizers
Operation			<ul style="list-style-type: none"> ▪ Configuring the operational display (e.g. display format, display contrast) ▪ Resetting and controlling totalizers
Setup		"Maintenance" role Commissioning: <ul style="list-style-type: none"> ▪ Configuration of the measurement ▪ Configuration of the inputs and outputs ▪ Configuration of the communication interface 	Wizards for fast commissioning: <ul style="list-style-type: none"> ▪ Setting the system units ▪ Displaying the I/O/configuration ▪ Configuring the inputs ▪ Configuring the outputs ▪ Configuration of the operational display ▪ Setting the low flow cut off ▪ Configuring empty pipe detection Advanced setup <ul style="list-style-type: none"> ▪ For more customized configuration of the measurement (adaptation to special measuring conditions) ▪ Configuration of totalizers ▪ Configuration of electrode cleaning (optional) ▪ Configuring the WLAN settings ▪ Administration (define access code, reset measuring device)
Diagnostics		"Maintenance" role Fault elimination: <ul style="list-style-type: none"> ▪ Diagnostics and elimination of process and device errors ▪ Measured value simulation 	Contains all parameters for error detection and analyzing process and device errors: <ul style="list-style-type: none"> ▪ Diagnostic list Contains up to 5 currently pending diagnostic messages. ▪ Event logbook Contains event messages that have occurred. ▪ Device information Contains information for identifying the device. ▪ Measured values Contains all current measured values. ▪ Analog inputs Is used to display the analog input. ▪ Data logging submenu with "Extended HistoROM" order option Storage and visualization of measured values ▪ Heartbeat The functionality of the device is checked on demand and the verification results are documented. ▪ Simulation Is used to simulate measured values or output values.

Menu/parameter		User role and tasks	Content/meaning
Expert	function-oriented	<p>Tasks that require detailed knowledge of the function of the device:</p> <ul style="list-style-type: none"> ▪ Commissioning measurements under difficult conditions ▪ Optimal adaptation of the measurement to difficult conditions ▪ Detailed configuration of the communication interface ▪ Error diagnostics in difficult cases 	<p>Contains all the parameters of the device and makes it possible to access these parameters directly using an access code. The structure of this menu is based on the function blocks of the device:</p> <ul style="list-style-type: none"> ▪ System Contains all higher-order device parameters which do not concern the measurement or the communication interface. ▪ Sensor Configuration of the measurement. ▪ Output Configure the pulse/frequency/switch output. ▪ Input Configuration of the status input. ▪ Output Configuration of the analog current outputs as well as the pulse/frequency and switch output. ▪ Communication Configuration of the digital communication interface and the Web server. ▪ Submenus for function blocks (e.g. "Analog Inputs") Configuration of function blocks. ▪ Application Configuration of the functions that go beyond the actual measurement (e.g. totalizer). ▪ Diagnostics Error detection and analysis of process and device errors and for device simulation and Heartbeat Technology.

8.3 Access to the operating menu via the local display

8.3.1 Operational display

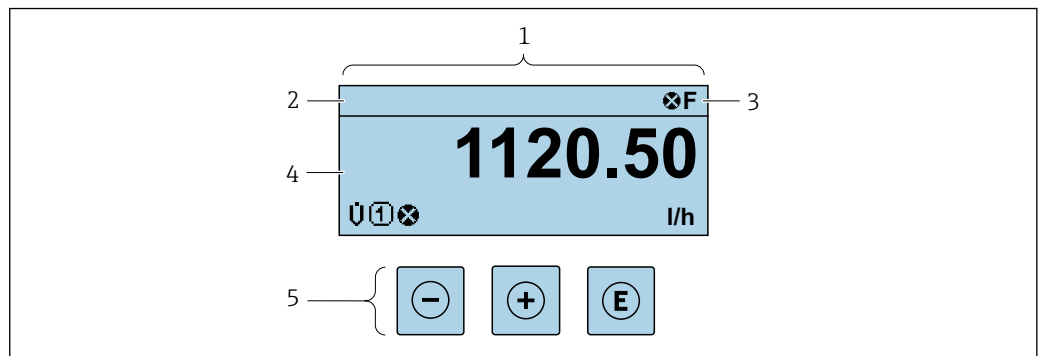

- 1 Operational display
- 2 Device tag → 92
- 3 Status area
- 4 Display area for measured values (4-line)
- 5 Operating elements → 61

A0029346

Status area

The following symbols appear in the status area of the operational display at the top right:

- Status signals → 143
 - **F**: Failure
 - **C**: Function check
 - **S**: Out of specification
 - **M**: Maintenance required
- Diagnostic behavior → 144
 - : Alarm
 - : Warning
 - : Locking (the device is locked via the hardware)
 - : Communication (communication via remote operation is active)

Display area

In the display area, each measured value is prefaced by certain symbol types for further description:

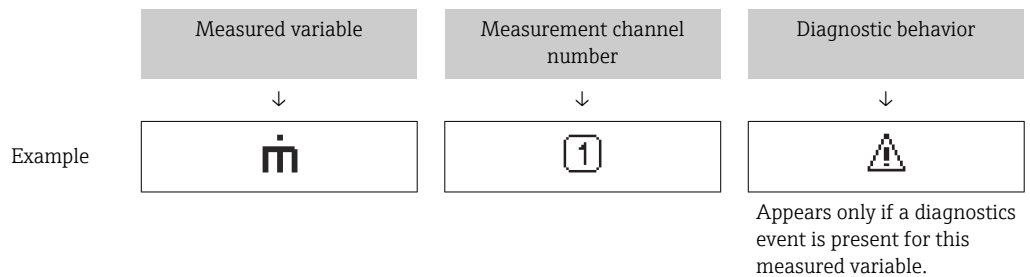

Measured values

Symbol	Meaning
	Volume flow
	Conductivity
	Mass flow
	Totalizer The measurement channel number indicates which of the three totalizers is displayed.
	Status input

Measurement channel numbers

Symbol	Meaning
	Measurement channel 1 to 4
The measurement channel number is displayed only if more than one channel is present for the same measured variable type (e.g. Totalizer 1 to 3).	

Diagnostic behavior

The diagnostic behavior pertains to a diagnostic event that is relevant to the displayed measured variable. For information on the symbols → 144

The number and display format of the measured values can be configured via the **Format display** parameter (→ 109).

8.3.2 Navigation view

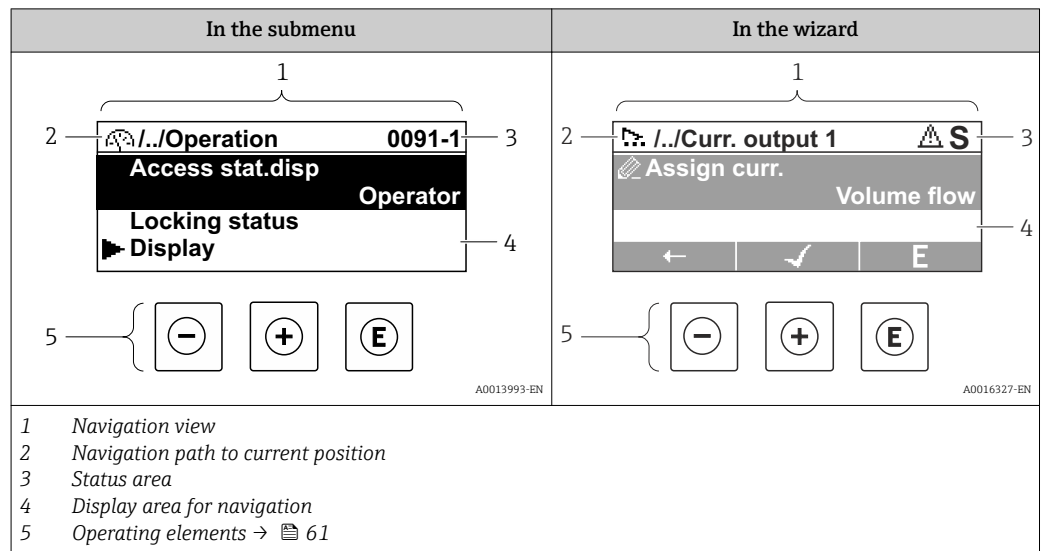

Navigation path

The navigation path - displayed at the top left in the navigation view - consists of the following elements:

	<ul style="list-style-type: none"> In the submenu: Display symbol for menu In the wizard: Display symbol for wizard 	Omission symbol for operating menu levels in between	Name of current <ul style="list-style-type: none"> Submenu Wizard Parameters
	↓	↓	↓
Examples		/ .. /	Display
		/ .. /	Display

For more information about the icons in the menu, refer to the "Display area" section → 58

Status area





The following appears in the status area of the navigation view in the top right corner:

- In the submenu
 - The direct access code for the parameter you are navigating to (e.g. 0022-1)
 - If a diagnostic event is present, the diagnostic behavior and status signal
- In the wizard
 - If a diagnostic event is present, the diagnostic behavior and status signal





- For information on the diagnostic behavior and status signal → 143
- For information on the function and entry of the direct access code → 63

Display area

Menus

Symbol	Meaning
	Operation Appears: <ul style="list-style-type: none"> In the menu next to the "Operation" selection At the left in the navigation path in the Operation menu
	Setup Appears: <ul style="list-style-type: none"> In the menu next to the "Setup" selection At the left in the navigation path in the Setup menu
	Diagnostics Appears: <ul style="list-style-type: none"> In the menu next to the "Diagnostics" selection At the left in the navigation path in the Diagnostics menu
	Expert Appears: <ul style="list-style-type: none"> In the menu next to the "Expert" selection At the left in the navigation path in the Expert menu



Submenus, wizards, parameters

Symbol	Meaning
	Submenu
	Wizard
	Parameters within a wizard  No display symbol exists for parameters in submenus.

Locking

Symbol	Meaning
	Parameter locked When displayed in front of a parameter name, indicates that the parameter is locked. <ul style="list-style-type: none"> By a user-specific access code By the hardware write protection switch

Wizard operation

Symbol	Meaning
	Switches to the previous parameter.
	Confirms the parameter value and switches to the next parameter.
	Opens the editing view of the parameter.

8.3.3 Editing view

Numeric editor

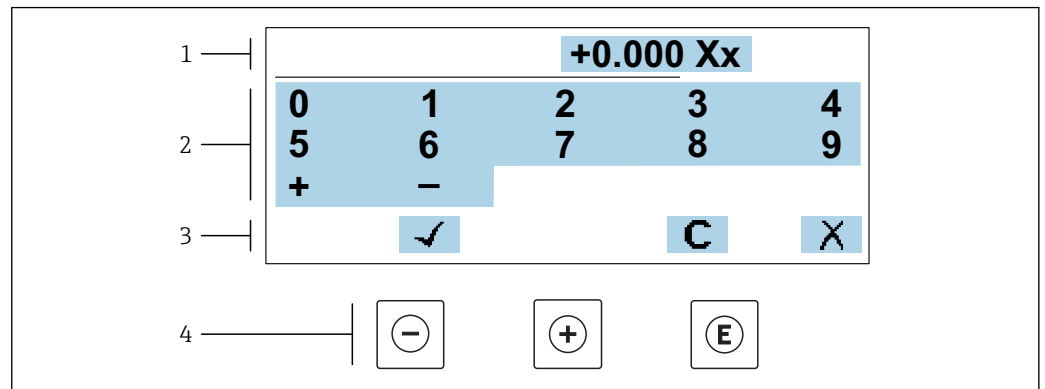

A0034250

21 For entering values in parameters (e.g. limit values)

- 1 Entry display area
- 2 Input screen
- 3 Confirm, delete or reject entry
- 4 Operating elements

Text editor

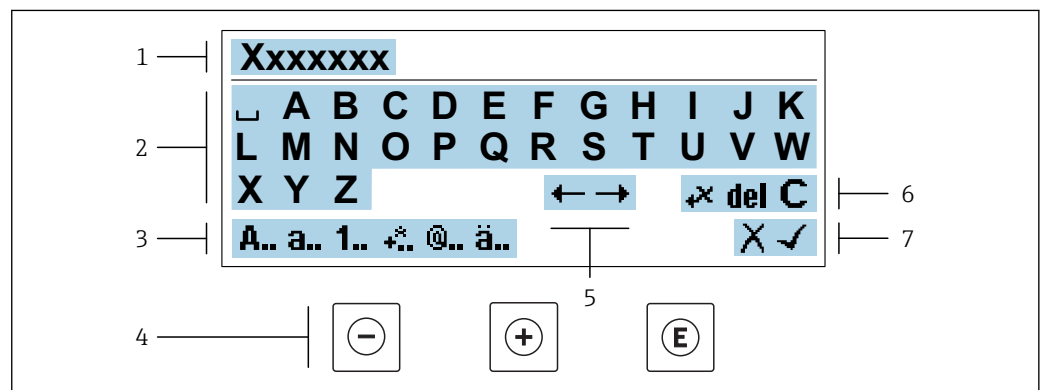



A0034114

22 For entering text in parameters (e.g. tag name)



- 1 Entry display area
- 2 Current input screen
- 3 Change input screen
- 4 Operating elements
- 5 Move entry position
- 6 Delete entry
- 7 Reject or confirm entry

Using the operating elements in the editing view





Operating key(s)	Meaning
	Minus key Move the entry position to the left.
	Plus key Move the entry position to the right.

Operating key(s)	Meaning
	Enter key <ul style="list-style-type: none"> ▪ Press the key briefly: confirm your selection. ▪ Press the key for 2 s: confirm the entry.
	Escape key combination (press keys simultaneously) Close the editing view without accepting the changes.





Input screens

Symbol	Meaning
A..	Upper case
a..	Lower case
1..	Numbers
	Punctuation marks and special characters: = + - * / ² ³ ¼ ½ ¾ () [] < > { }
	Punctuation marks and special characters: " ` ^ . , ; : ? ! % μ ° € \$ £ ¥ \$ @ # / \ ~ & _
ä..	Umlauts and accents

Controlling data entries

Symbol	Meaning
	Move entry position
	Reject entry
	Confirm entry
	Delete character immediately to the left of the entry position
del	Delete character immediately to the right of the entry position
C	Clear all the characters entered

8.3.4 Operating elements

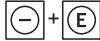
Operating key(s)	Meaning
	<p>Minus key</p> <p><i>In a menu, submenu</i> Moves the selection bar upwards in a picklist.</p> <p><i>With a Wizard</i> Confirms the parameter value and goes to the previous parameter.</p> <p><i>With a text and numeric editor</i> Move the entry position to the left.</p>
	<p>Plus key</p> <p><i>In a menu, submenu</i> Moves the selection bar downwards in a picklist.</p> <p><i>With a Wizard</i> Confirms the parameter value and goes to the next parameter.</p> <p><i>With a text and numeric editor</i> Move the entry position to the right.</p>
	<p>Enter key</p> <p><i>For operational display</i> Pressing the key briefly opens the operating menu.</p> <p><i>In a menu, submenu</i></p> <ul style="list-style-type: none"> ▪ Pressing the key briefly: <ul style="list-style-type: none"> ▪ Opens the selected menu, submenu or parameter. ▪ Starts the wizard. ▪ If help text is open, closes the help text of the parameter. ▪ Pressing the key for 2 s for parameter: <ul style="list-style-type: none"> ▪ If present, opens the help text for the function of the parameter. <p><i>With a Wizard</i> Opens the editing view of the parameter.</p> <p><i>With a text and numeric editor</i></p> <ul style="list-style-type: none"> ▪ Press the key briefly: confirm your selection. ▪ Press the key for 2 s: confirm the entry.
	<p>Escape key combination (press keys simultaneously)</p> <p><i>In a menu, submenu</i></p> <ul style="list-style-type: none"> ▪ Pressing the key briefly: <ul style="list-style-type: none"> ▪ Exits the current menu level and takes you to the next higher level. ▪ If help text is open, closes the help text of the parameter. ▪ Pressing the key for 2 s returns you to the operational display ("home position"). <p><i>With a Wizard</i> Exits the wizard and takes you to the next higher level.</p> <p><i>With a text and numeric editor</i> Close the editing view without accepting the changes.</p>
	<p>Minus/Enter key combination (press the keys simultaneously)</p> <ul style="list-style-type: none"> ▪ If the keypad lock is active: Press the key for 3 s: deactivate the keypad lock. ▪ If the keypad lock is not active: Press the key for 3 s: the context menu opens along with the option for activating the keypad lock.



8.3.5 Opening the context menu

Using the context menu, the user can call up the following menus quickly and directly from the operational display:

- Setup
- Data backup
- Simulation



Calling up and closing the context menu

The user is in the operational display.

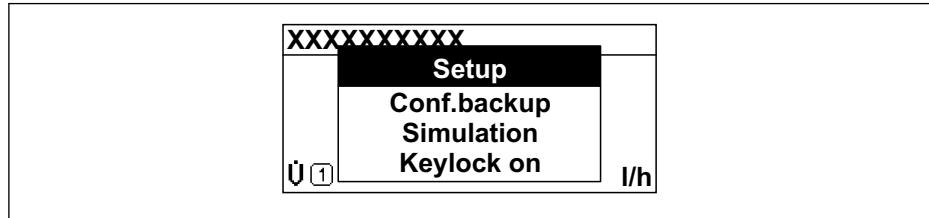

1. Press the  and  keys for longer than 3 seconds.
 - ↳ The context menu opens.



A0034608-EN

2. Press  +  simultaneously.
 - ↳ The context menu is closed and the operational display appears.

Calling up the menu via the context menu

1. Open the context menu.
2. Press  to navigate to the desired menu.
3. Press  to confirm the selection.
 - ↳ The selected menu opens.

8.3.6 Navigating and selecting from list

Different operating elements are used to navigate through the operating menu. The navigation path is displayed on the left in the header. Icons are displayed in front of the individual menus. These icons are also shown in the header during navigation.

i For an explanation of the navigation view with symbols and operating elements → 57

Example: Setting the number of displayed measured values to "2 values"

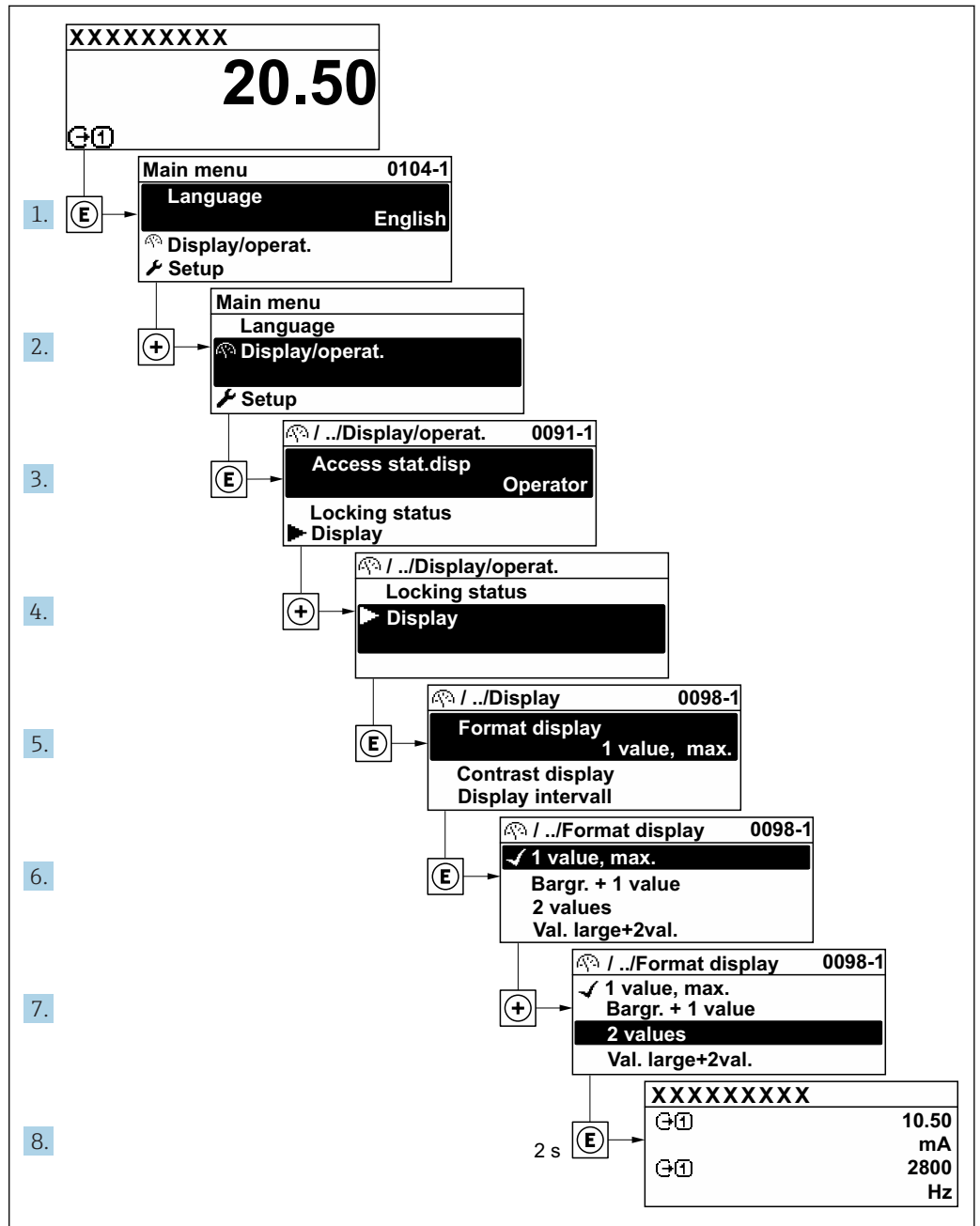

A0029562-EN

8.3.7 Calling the parameter directly

A parameter number is assigned to every parameter to be able to access a parameter directly via the onsite display. Entering this access code in the **Direct access** parameter calls up the desired parameter directly.

Navigation path

Expert → Direct access

The direct access code consists of a 5-digit number (at maximum) and the channel number, which identifies the channel of a process variable: e.g. 00914-2. In the navigation view, this appears on the right-hand side in the header of the selected parameter.

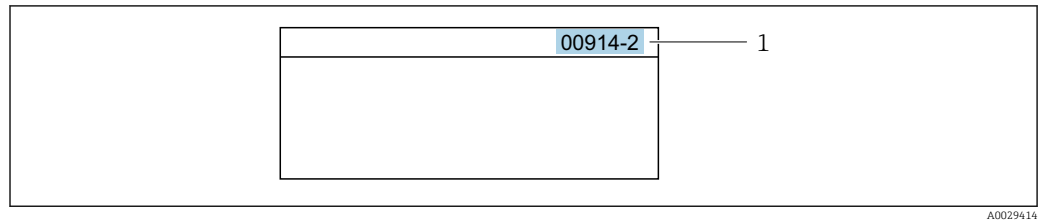

1 Direct access code

Note the following when entering the direct access code:

- The leading zeros in the direct access code do not have to be entered.
Example: Enter "914" instead of "00914"
- If no channel number is entered, channel 1 is accessed automatically.
Example: Enter 00914 → **Assign process variable** parameter
- If a different channel is accessed: Enter the direct access code with the corresponding channel number.
Example: Enter 00914-2 → **Assign process variable** parameter



For the direct access codes of the individual parameters, see the "Description of Device Parameters" document for the device

8.3.8 Calling up help text

Help text is available for some parameters and can be called up from the navigation view. The help text provides a brief explanation of the parameter function and thereby supports swift and safe commissioning.

Calling up and closing the help text

The user is in the navigation view and the selection bar is on a parameter.

1. Press for 2 s.
↳ The help text for the selected parameter opens.

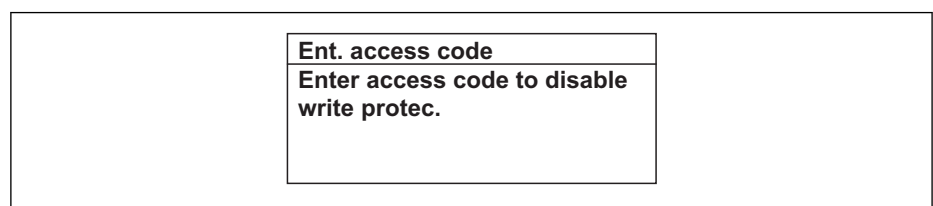

23 Example: Help text for parameter "Enter access code"

2. Press + simultaneously.
↳ The help text is closed.

8.3.9 Changing the parameters

Parameters can be changed via the numeric editor or text editor.

- Numeric editor: Change values in a parameter, e.g. specifications for limit values.
- Text editor: Enter text in a parameter, e.g. tag name.

A message is displayed if the value entered is outside the permitted value range.

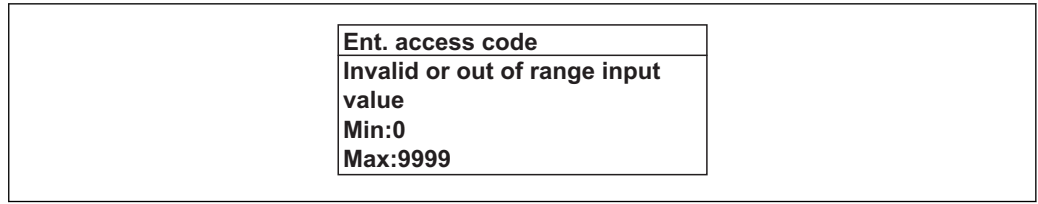

A0014049-EN

For a description of the editing view - consisting of the text editor and numeric editor - with symbols → 59, for a description of the operating elements → 61

8.3.10 User roles and related access authorization

The two user roles "Operator" and "Maintenance" have different write access to the parameters if the customer defines a user-specific access code. This protects the device configuration via the local display from unauthorized access → 126.

Defining access authorization for user roles

An access code is not yet defined when the device is delivered from the factory. Access authorization (read and write access) to the device is not restricted and corresponds to the "Maintenance" user role.

- ▶ Define the access code.
 - ↳ The "Operator" user role is redefined in addition to the "Maintenance" user role. Access authorization differs for the two user roles.

Access authorization to parameters: "Maintenance" user role

Access code status	Read access	Write access
An access code has not yet been defined (factory setting).	✓	✓
After an access code has been defined.	✓	✓ ¹⁾

1) The user only has write access after entering the access code.

Access authorization to parameters: "Operator" user role

Access code status	Read access	Write access
After an access code has been defined.	✓	-- ¹⁾

1) Despite the defined access code, certain parameters can always be modified and thus are exempted from the write protection, as they do not affect the measurement. Refer to the "Write protection via access code" section

The user role with which the user is currently logged on is indicated by the **Access status** parameter. Navigation path: Operation → Access status

8.3.11 Disabling write protection via access code

If the -symbol appears on the local display in front of a parameter, the parameter is write-protected by a user-specific access code and its value cannot be changed at the moment using local operation → 126.

Parameter write protection via local operation can be disabled by entering the user-specific access code in the **Enter access code** parameter via the respective access option.

1. After you press , the input prompt for the access code appears.

2. Enter the access code.
 - ↳ The -symbol in front of the parameters disappears; all previously write-protected parameters are now re-enabled.

8.3.12 Enabling and disabling the keypad lock



The keypad lock makes it possible to block access to the entire operating menu via local operation. As a result, it is no longer possible to navigate through the operating menu or change the values of individual parameters. Users can only read the measured values on the operational display.

The keypad lock is switched on and off via the context menu.

Switching on the keypad lock



-  The keypad lock is switched on automatically:
- If the device has not been operated via the display for > 1 minute.
 - Each time the device is restarted.

To activate the keylock manually:

1. The device is in the measured value display.
Press the  and  keys for 3 seconds.
 - ↳ A context menu appears.
2. In the context menu select the **Keylock on** option.
 - ↳ The keypad lock is switched on.

-  If the user attempts to access the operating menu while the keypad lock is active, the **Keylock on** message appears.

Switching off the keypad lock

- ▶ The keypad lock is switched on.
Press the  and  keys for 3 seconds.
 - ↳ The keypad lock is switched off.

8.4 Access to the operating menu via the Web browser

8.4.1 Function range

Thanks to the integrated Web server, the device can be operated and configured via a Web browser and via a service interface (CDI-RJ45) or via a WLAN interface. The structure of the operating menu is the same as for the local display. In addition to the measured values, status information on the device is also displayed and allows the user to monitor the status of the device. Furthermore the device data can be managed and the network parameters can be configured.

A device that has a WLAN interface (can be ordered as an option) is required for the WLAN connection: order code for "Display; operation", option G "4-line, illuminated; touch control + WLAN". The device acts as an Access Point and enables communication by computer or a mobile handheld terminal.

-  For additional information on the Web server, refer to the Special Documentation for the device

8.4.2 Prerequisites



Computer hardware

Hardware	Interface	
	CDI-RJ45	WLAN
Interface	The computer must have an RJ45 interface.	The operating unit must have a WLAN interface.
Connection	Standard Ethernet cable with RJ45 connector.	Connection via Wireless LAN.
Screen	Recommended size: ≥ 12" (depends on the screen resolution)	

Computer software



Software	Interface	
	CDI-RJ45	WLAN
Recommended operating systems	<ul style="list-style-type: none"> ▪ Microsoft Windows 7 or higher. ▪ Mobile operating systems: <ul style="list-style-type: none"> ▪ iOS ▪ Android <p> Microsoft Windows XP is supported.</p>	
Web browsers supported	<ul style="list-style-type: none"> ▪ Microsoft Internet Explorer 8 or higher ▪ Microsoft Edge ▪ Mozilla Firefox ▪ Google Chrome ▪ Safari 	

Computer settings



Settings	Interface	
	CDI-RJ45	WLAN
User rights	Appropriate user rights (e.g. administrator rights) for TCP/IP and proxy server settings are necessary (for adjusting the IP address, subnet mask etc.).	
Proxy server settings of the Web browser	The Web browser setting <i>Use a Proxy Server for Your LAN</i> must be deselected .	
JavaScript	JavaScript must be enabled. <p> If JavaScript cannot be enabled: enter <code>http://192.168.1.212/basic.html</code> in the address line of the Web browser. A fully functional but simplified version of the operating menu structure starts in the Web browser.</p> <p> When installing a new firmware version: To enable correct data display, clear the temporary memory (cache) of the Web browser under Internet options.</p>	
Network connections	Only the active network connections to the measuring device should be used.	
	Switch off all other network connections such as WLAN.	Switch off all other network connections.

 In the event of connection problems: →  140

Measuring device: Via CDI-RJ45 service interface

Device	CDI-RJ45 service interface
Measuring device	The measuring device has an RJ45 interface.
Web server	Web server must be enabled; factory setting: ON  For information on enabling the Web server →  72

Measuring device: via WLAN interface

Device	WLAN interface
Measuring device	The measuring device has a WLAN antenna: <ul style="list-style-type: none"> ▪ Transmitter with integrated WLAN antenna ▪ Transmitter with external WLAN antenna
Web server	Web server and WLAN must be enabled; factory setting: ON  For information on enabling the Web server →  72

8.4.3 Establishing a connection

Via service interface (CDI-RJ45)

Preparing the measuring device

1. Depending on the housing version:
Release the securing clamp or securing screw of the housing cover.
2. Depending on the housing version:
Unscrew or open the housing cover.
3. The location of the connection socket depends on the measuring device and the communication protocol:
Connect the computer to the RJ45 connector via the standard Ethernet connecting cable .

Configuring the Internet protocol of the computer

The following information refers to the default Ethernet settings of the device.

IP address of the device: 192.168.1.212 (factory setting)

1. Switch on the measuring device.
2. Connect to the computer using a cable →  73.
3. If a 2nd network card is not used, close all the applications on the notebook.
 - ↳ Applications requiring Internet or a network, such as e-mail, SAP applications, Internet or Windows Explorer.
4. Close any open Internet browsers.
5. Configure the properties of the Internet protocol (TCP/IP) as defined in the table:

IP address	192.168.1.XXX; for XXX all numerical sequences except: 0, 212 and 255 → e.g. 192.168.1.213
Subnet mask	255.255.255.0
Default gateway	192.168.1.212 or leave cells empty

Via WLAN interface

Configuring the Internet protocol of the mobile terminal

NOTICE

If the WLAN connection is lost during the configuration, settings made may be lost.

- ▶ Make sure that the WLAN connection is not disconnected while configuring the device.

NOTICE

In principle, avoid simultaneous access to the measuring device via the service interface (CDI-RJ45) and the WLAN interface from the same mobile terminal. This could cause a network conflict.

- ▶ Only activate one service interface (CDI-RJ45 service interface or WLAN interface).
- ▶ If simultaneous communication is necessary: configure different IP address ranges, e.g. 192.168.0.1 (WLAN interface) and 192.168.1.212 (CDI-RJ45 service interface).

Preparing the mobile terminal

- ▶ Enable WLAN reception on the mobile terminal.

Establishing a connection from the mobile terminal to the measuring device

1. In the WLAN settings of the mobile terminal:
Select the measuring device using the SSID (e.g. EH_Promag_300_A802000).
2. If necessary, select the WPA2 encryption method.
3. Enter the password: serial number of the measuring device ex-works (e.g. L100A802000).
 - ↳ LED on display module flashes: it is now possible to operate the measuring device with the Web browser, FieldCare or DeviceCare.



The serial number can be found on the nameplate.



To ensure the safe and swift assignment of the WLAN network to the measuring point, it is advisable to change the SSID name. It should be possible to clearly assign the new SSID name to the measuring point (e.g. tag name) because it is displayed as the WLAN network.

Disconnecting

- ▶ After configuring the device:
Terminate the WLAN connection between the operating unit and measuring device.

Starting the Web browser

1. Start the Web browser on the computer.

2. Enter the IP address of the Web server in the address line of the Web browser:
192.168.1.212
↳ The login page appears.

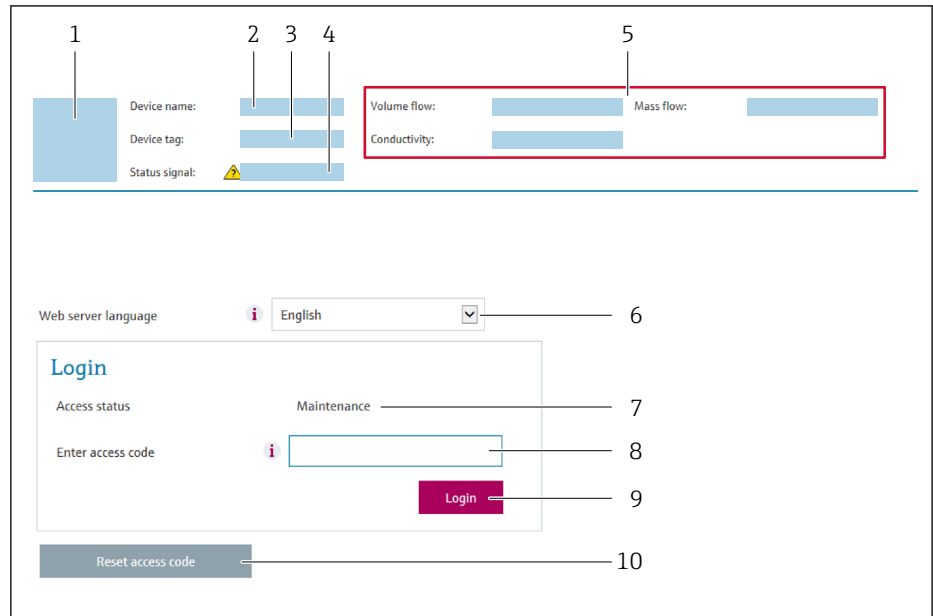

A0029417

- 1 Picture of device
- 2 Device name
- 3 Device tag
- 4 Status signal
- 5 Current measured values
- 6 Operating language
- 7 User role
- 8 Access code
- 9 Login
- 10 Reset access code (→ 123)

i If a login page does not appear, or if the page is incomplete → 140

8.4.4 Logging on

1. Select the preferred operating language for the Web browser.
2. Enter the user-specific access code.
3. Press **OK** to confirm your entry.

Access code	0000 (factory setting); can be changed by customer
-------------	--

i If no action is performed for 10 minutes, the Web browser automatically returns to the login page.

8.4.5 User interface

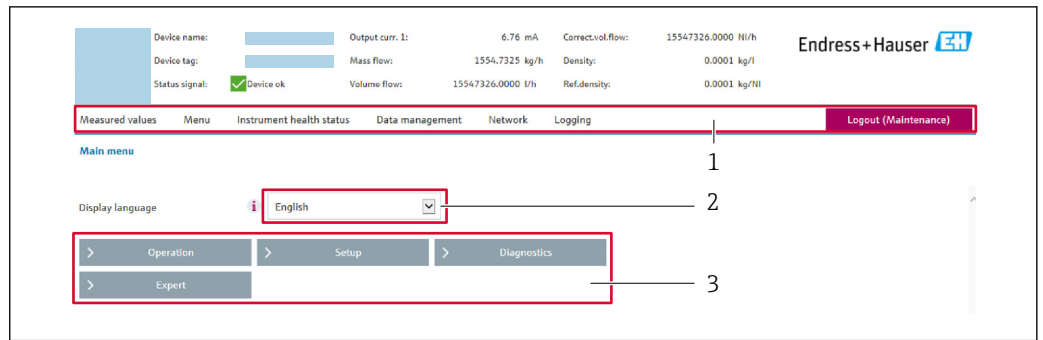

A0029418

- 1 Function row
- 2 Local display language
- 3 Navigation area

Header

The following information appears in the header:

- Device name
- Device tag
- Device status with status signal → 📄 146
- Current measured values

Function row

Functions	Meaning
Measured values	Displays the measured values of the measuring device
Menu	<ul style="list-style-type: none"> ■ Access to the operating menu from the measuring device ■ The structure of the operating menu is the same as for the local display  For detailed information on the structure of the operating menu, see the Operating Instructions for the measuring device
Device status	Displays the diagnostic messages currently pending, listed in order of priority
Data management	Data exchange between PC and measuring device: <ul style="list-style-type: none"> ■ Device configuration: <ul style="list-style-type: none"> ■ Load settings from the device (XML format, save configuration) ■ Save settings to the device (XML format, restore configuration) ■ Logbook - Export Event logbook (.csv file) ■ Documents - Export documents: <ul style="list-style-type: none"> ■ Export backup data record (.csv file, create documentation of the measuring point configuration) ■ Verification report (PDF file, only available with the "Heartbeat Verification" application package) ■ File for system integration - If using fieldbuses, upload device drivers for system integration from the measuring device: <ul style="list-style-type: none"> PROFIBUS PA: GSD file ■ Firmware update - Flashing a firmware version
Network configuration	Configuration and checking of all the parameters required for establishing the connection to the measuring device: <ul style="list-style-type: none"> ■ Network settings (e.g. IP address, MAC address) ■ Device information (e.g. serial number, firmware version)
Logout	End the operation and call up the login page

Navigation area

If a function is selected in the function bar, the submenus of the function open in the navigation area. The user can now navigate through the menu structure.

Working area

Depending on the selected function and the related submenus, various actions can be performed in this area:

- Configuring parameters
- Reading measured values
- Calling up help text
- Starting an upload/download

8.4.6 Disabling the Web server

The Web server of the measuring device can be switched on and off as required using the **Web server functionality** parameter.

Navigation

"Expert" menu → Communication → Web server

Parameter overview with brief description

Parameter	Description	Selection	Factory setting
Web server functionality	Switch the Web server on and off.	<ul style="list-style-type: none"> ▪ Off ▪ HTML Off ▪ On 	On

Function scope of the "Web server functionality" parameter

Option	Description
Off	<ul style="list-style-type: none"> ▪ The web server is completely disabled. ▪ Port 80 is locked.
HTML Off	The HTML version of the web server is not available.
On	<ul style="list-style-type: none"> ▪ The complete functionality of the web server is available. ▪ JavaScript is used. ▪ The password is transferred in an encrypted state. ▪ Any change to the password is also transferred in an encrypted state.

Enabling the Web server

If the Web server is disabled it can only be re-enabled with the **Web server functionality** parameter via the following operating options:

- Via local display
- Via Bedientool "FieldCare"
- Via "DeviceCare" operating tool

8.4.7 Logging out

 Before logging out, perform a data backup via the **Data management** function (upload configuration from device) if necessary.

1. Select the **Logout** entry in the function row.
↳ The home page with the Login box appears.
2. Close the Web browser.

3. If no longer needed:
Reset modified properties of the Internet protocol (TCP/IP) → 68.

8.5 Access to the operating menu via the operating tool

The structure of the operating menu in the operating tools is the same as for operation via the local display.

8.5.1 Connecting the operating tool

Via PROFIBUS PA network

This communication interface is available in device versions with PROFIBUS PA.

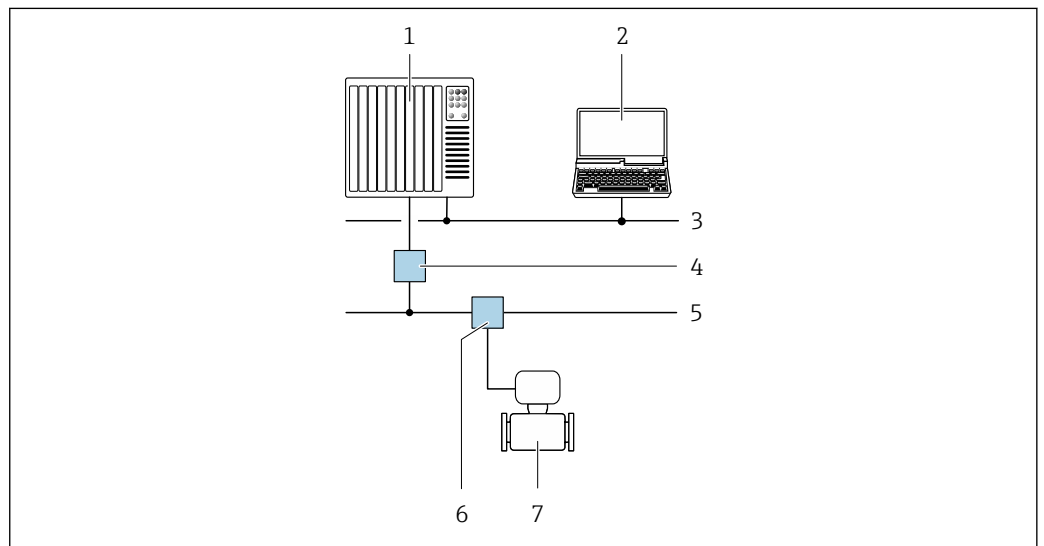

24 Options for remote operation via PROFIBUS PA network

- 1 Automation system
- 2 Computer with PROFIBUS network card
- 3 PROFIBUS DP network
- 4 Segment coupler PROFIBUS DP/PA
- 5 PROFIBUS PA network
- 6 T-box
- 7 Measuring device

Service interface

Via service interface (CDI-RJ45)

A point-to-point connection can be established to configure the device onsite. With the housing open, the connection is established directly via the service interface (CDI-RJ45) of the device.

- i** An adapter for RJ45 and the M12 connector is optionally available:
Order code for "Accessories", option **NB**: "Adapter RJ45 M12 (service interface)"

The adapter connects the service interface (CDI-RJ45) to an M12 connector mounted in the cable entry. Therefore the connection to the service interface can be established via an M12 connector without opening the device.

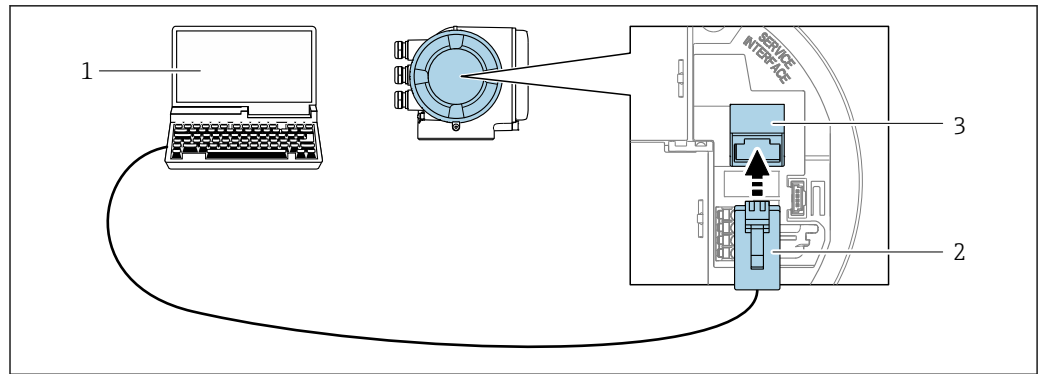

A0027563

25 Connection via service interface (CDI-RJ45)

- 1 Computer with Web browser (e.g. Microsoft Internet Explorer, Microsoft Edge) for accessing the integrated device Web server or with "FieldCare", "DeviceCare" operating tool with COM DTM "CDI Communication TCP/IP"
- 2 Standard Ethernet connecting cable with RJ45 connector
- 3 Service interface (CDI-RJ45) of the measuring device with access to the integrated Web server

Via WLAN interface

The optional WLAN interface is available on the following device version:

Order code for "Display; operation", option G "4-line, illuminated; touch control + WLAN"

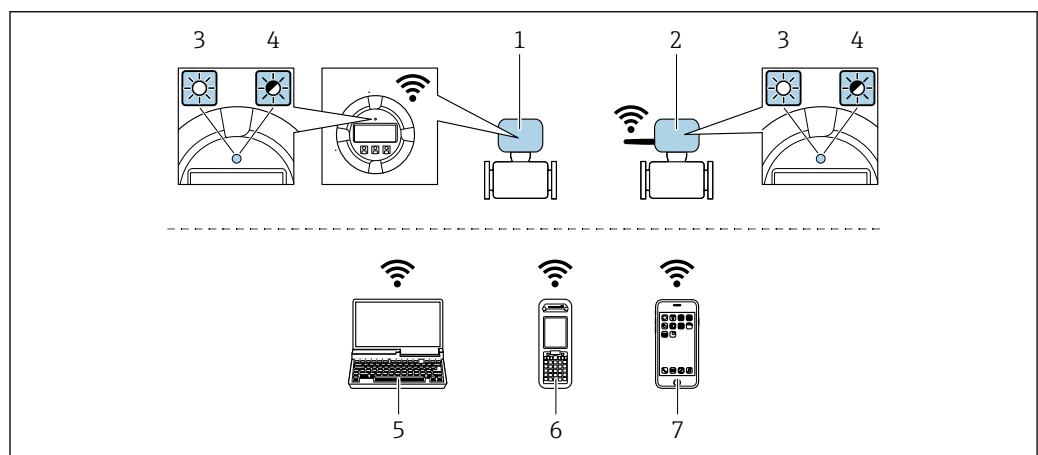

A0034570

- 1 Transmitter with integrated WLAN antenna
- 2 Transmitter with external WLAN antenna
- 3 LED lit constantly: WLAN reception is enabled on measuring device
- 4 LED flashing: WLAN connection established between operating unit and measuring device
- 5 Computer with WLAN interface and Web browser (e.g. Microsoft Internet Explorer, Microsoft Edge) for accessing the integrated device Web server or with operating tool (e.g. FieldCare, DeviceCare)
- 6 Mobile handheld terminal with WLAN interface and Web browser (e.g. Microsoft Internet Explorer, Microsoft Edge) for accessing the integrated device Web server or operating tool (e.g. FieldCare, DeviceCare)
- 7 Smart phone or tablet (e.g. Field Xpert SMT70)

Function	WLAN: IEEE 802.11 b/g (2.4 GHz)
Encryption	WPA2-PSK AES-128 (in accordance with IEEE 802.11i)
Configurable WLAN channels	1 to 11
Degree of protection	IP67
Available antennas	<ul style="list-style-type: none"> ▪ Internal antenna ▪ External antenna (optional) In the event of poor transmission/reception conditions at the place of installation. <p> Only one antenna active in each case!</p>

Range	<ul style="list-style-type: none"> ▪ Internal antenna: typically 10 m (32 ft) ▪ External antenna: typically 50 m (164 ft)
Materials (external antenna)	<ul style="list-style-type: none"> ▪ Antenna: ASA plastic (acrylic ester-styrene-acrylonitrile) and nickel-plated brass ▪ Adapter: Stainless steel and nickel-plated brass ▪ Cable: Polyethylene ▪ Connector: Nickel-plated brass ▪ Angle bracket: Stainless steel

Configuring the Internet protocol of the mobile terminal

NOTICE

If the WLAN connection is lost during the configuration, settings made may be lost.

- ▶ Make sure that the WLAN connection is not disconnected while configuring the device.

NOTICE

In principle, avoid simultaneous access to the measuring device via the service interface (CDI-RJ45) and the WLAN interface from the same mobile terminal. This could cause a network conflict.

- ▶ Only activate one service interface (CDI-RJ45 service interface or WLAN interface).
- ▶ If simultaneous communication is necessary: configure different IP address ranges, e.g. 192.168.0.1 (WLAN interface) and 192.168.1.212 (CDI-RJ45 service interface).

Preparing the mobile terminal

- ▶ Enable WLAN reception on the mobile terminal.

Establishing a connection from the mobile terminal to the measuring device

1. In the WLAN settings of the mobile terminal:
Select the measuring device using the SSID (e.g. EH_Promag_300_A802000).
2. If necessary, select the WPA2 encryption method.
3. Enter the password: serial number of the measuring device ex-works (e.g. L100A802000).
↳ LED on display module flashes: it is now possible to operate the measuring device with the Web browser, FieldCare or DeviceCare.

 The serial number can be found on the nameplate.

 To ensure the safe and swift assignment of the WLAN network to the measuring point, it is advisable to change the SSID name. It should be possible to clearly assign the new SSID name to the measuring point (e.g. tag name) because it is displayed as the WLAN network.

Disconnecting



- ▶ After configuring the device:
Terminate the WLAN connection between the operating unit and measuring device.

8.5.2 FieldCare

Function scope

FDT-based plant asset management tool from Endress+Hauser. It can configure all smart field devices in a system and helps you manage them. By using the status information, it is also a simple but effective way of checking their status and condition.

Access is via:

- PROFIBUS PA protocol →  73
- CDI-RJ45 service interface →  73
- WLAN interface →  74

Typical functions:

- Configuring parameters of transmitters
- Loading and saving device data (upload/download)
- Documentation of the measuring point
- Visualization of the measured value memory (line recorder) and event logbook



For additional information about FieldCare, see Operating Instructions BA00027S and BA00059S

Source for device description files

See information →  79

Establishing a connection

1. Start FieldCare and launch the project.
2. In the network: Add a device.
 - ↳ The **Add device** window opens.
3. Select the **CDI Communication TCP/IP** option from the list and press **OK** to confirm.
4. Right-click **CDI Communication TCP/IP** and select the **Add device** option in the context menu that opens.
5. Select the desired device from the list and press **OK** to confirm.
 - ↳ The **CDI Communication TCP/IP (Configuration)** window opens.
6. Enter the device address in the **IP address** field: 192.168.1.212 and press **Enter** to confirm.
7. Establish the online connection to the device.



For additional information, see Operating Instructions BA00027S and BA00059S

User interface

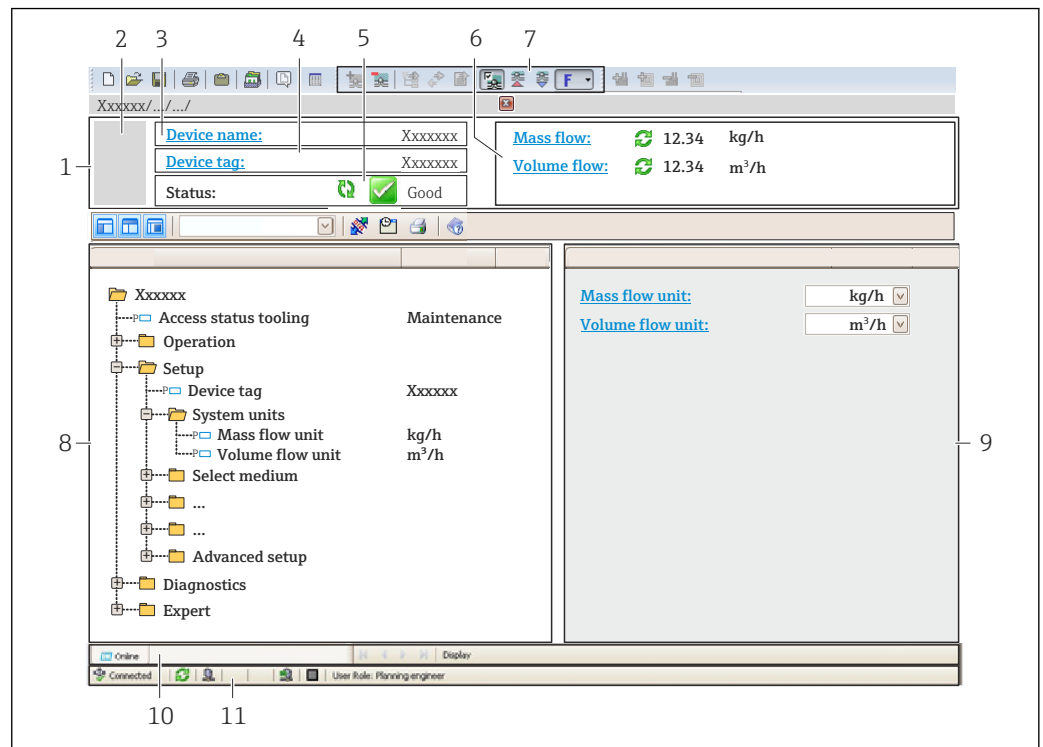

A0021051-EN

- 1 Header
- 2 Picture of device
- 3 Device name
- 4 Device tag
- 5 Status area with status signal → 146
- 6 Display area for current measured values
- 7 Edit toolbar with additional functions such as save/restore, event list and create documentation
- 8 Navigation area with operating menu structure
- 9 Working area
- 10 Range of action
- 11 Status area

8.5.3 DeviceCare

Function scope

Tool to connect and configure Endress+Hauser field devices.

The fastest way to configure Endress+Hauser field devices is with the dedicated "DeviceCare" tool. Together with the device type managers (DTMs) it presents a convenient, comprehensive solution.

 For details, see Innovation Brochure IN01047S

Source for device description files

See information → 79

8.5.4 SIMATIC PDM

Function scope

SIMATIC PDM is a standardized, manufacturer-independent program from Siemens for the operation, configuration, maintenance and diagnosis of intelligent field devices via PROFIBUS PA protocol.

Source for device description files

See data →  79

9 System integration

9.1 Overview of device description files

9.1.1 Current version data for the device

Firmware version	01.01.zz	<ul style="list-style-type: none"> ▪ On the title page of the Operating instructions ▪ On the transmitter nameplate ▪ Firmware version Diagnostics → Device information → Firmware version
Release date of firmware version	11.2018	---
Manufacturer ID	0x11	Manufacturer ID Diagnostics → Device information → Manufacturer ID
Device type ID	0x156C	Device type Diagnostics → Device information → Device type
Profile version	3.02	---

 For an overview of the different firmware versions for the device →  180

9.1.2 Operating tools

The suitable device description file for the individual operating tools is listed in the table below, along with information on where the file can be acquired.

Operating tool via PROFIBUS protocol	Sources for obtaining device descriptions
FieldCare	<ul style="list-style-type: none"> ▪ www.endress.com → Download Area ▪ CD-ROM (contact Endress+Hauser) ▪ DVD (contact Endress+Hauser)
DeviceCare	<ul style="list-style-type: none"> ▪ www.endress.com → Download Area ▪ CD-ROM (contact Endress+Hauser) ▪ DVD (contact Endress+Hauser)
SIMATIC PDM (Siemens)	www.endress.com → Download Area

9.2 Device master file (GSD)

In order to integrate field devices into a bus system, the PROFIBUS system needs a description of the device parameters, such as output data, input data, data format, data volume and supported transmission rate.

These data are available in the device master file (GSD) which is provided to the PROFIBUS Master when the communication system is commissioned. In addition device bit maps, which appear as icons in the network structure, can also be integrated.

With the Profile 3.02 device master file (GSD) it is possible to exchange field devices made by different manufacturers without having to reconfigure.

Generally speaking, it is possible to use two different GSDs with Profile 3.02 and higher: the manufacturer-specific GSD and the Profile GSD.

-  Before configuring, the user must decide which GSD should be used to operate the system.
 - The setting can be changed via a Class 2 master.

9.2.1 Manufacturer-specific GSD

This GSD guarantees the unrestricted functionality of the measuring device. Device-specific process parameters and functions are therefore available.

Manufacturer-specific GSD	ID number	File name
PROFIBUS PA	0x156C	EH3x156C.gsd

Use manufacturer-specific GSD

Assignment is performed in the **Ident number selector** parameter via the **Manufacturer** option.



Sources of supply for the manufacturer-specific GSD:

- Export directly from the device via the integrated web server:
Data management → Documents → Export GSD file
- Download via the Endress+Hauser website:
www.endress.com → Download-Area

9.2.2 Profile GSD

Differs in terms of the number of Analog Input blocks (AI) and the measured values. If a system is configured with a Profile GSD, it is possible to exchange devices made by different manufacturers. However, it is essential to ensure that the order of the cyclic process values is correct.

ID number	Supported blocks	Supported channels
0x9740	<ul style="list-style-type: none"> ▪ 1 Analog Input ▪ 1 Totalizer 	<ul style="list-style-type: none"> ▪ Channel Analog Input: volume flow ▪ Channel totalizer: volume flow
0x9741	<ul style="list-style-type: none"> ▪ 2 Analog Input ▪ 1 Totalizer 	<ul style="list-style-type: none"> ▪ Channel Analog Input 1: volume flow ▪ Channel Analog Input 2: mass flow ▪ Channel totalizer: volume flow
0x9742	<ul style="list-style-type: none"> ▪ 3 Analog Input ▪ 1 Totalizer 	<ul style="list-style-type: none"> ▪ Channel Analog Input 1: volume flow ▪ Channel Analog Input 2: mass flow ▪ Channel Analog Input 3: corrected volume flow ▪ Channel totalizer: volume flow

Use profile GSD

Assignment is performed in the **Ident number selector** parameter:

- ID number 0x9740: **1 AI, 1 Totalizer (0x9740)** option
- ID number 0x9741: **2 AI, 1 Totalizer (0x9741)** option
- ID number 0x9742: **Profile** option

9.3 Compatibility with earlier model

If the device is replaced, the measuring device Promag 300 supports the compatibility of the cyclic data with previous models. It is not necessary to adjust the engineering parameters of the PROFIBUS network with the Promag 300 GSD file.

Earlier models:

- Promag 50PROFIBUS PA
 - ID No.: 1525 (hex)
 - Extended GSD file: EH3x1525.gsd
 - Standard GSD file: EH3_1525.gsd
- Promag 53PROFIBUS PA
 - ID No.: 1527 (hex)
 - Extended GSD file: EH3x1527.gsd
 - Standard GSD file: EH3_1527.gsd

9.3.1 Automatic identification (factory setting)

The Promag 300 PROFIBUS PA automatically recognizes the measuring device configured in the automation system (Promag 50 PROFIBUS PA oder Promag 53 PROFIBUS PA) and makes the same input and output data and measured value status information available for cyclic data exchange.

Automatic identification is set in the **Ident number selector** parameter using the **Automatic mode** option (factory setting).

9.3.2 Manual setting

The manual setting is made in the **Ident number selector** parameter via the **Promag 50 (0x1525)** option or **Promag 53 (0x1527)** option.

Afterwards the Promag 300 PROFIBUS PA makes the same input and output data and measured value status information available for cyclic data exchange.

- If the Promag 300 PROFIBUS PA is acyclically configured via an operating program (Class 2 master), access is directly via the block structure or the parameters of the measuring device.
- If parameters have been changed in the device to be replaced (Promag 50 PROFIBUS PA or Promag 53 PROFIBUS PA) (parameter setting no longer corresponds to the original factory setting), these parameters must be changed accordingly in the new replacement Promag 300 PROFIBUS PA via an operating program (Class 2 master).

Example

The setting for low flow cut off has been changed from mass flow (factory setting) to corrected volume flow in a Promag 50 PROFIBUS PA currently in operation. This device is now replaced by a Promag 300 PROFIBUS PA.

After replacing the device, the assignment for the low flow cut off must also be changed manually in the Promag 300 PROFIBUS PA, i.e. to corrected volume flow, to ensure the measuring device behaves identically.

9.3.3 Replacing the measuring devices without changing the GSD file or restarting the controller

In the procedure described below, the device can be replaced without interrupting ongoing operation or restarting the controller. However with this procedure the measuring device is not fully integrated!

1. Replace the measuring device Promag 50 PROFIBUS PA or Promag 53 PROFIBUS PA with a Promag 300 PROFIBUS PA.

2. Set the device address: The same device address that was set for the Promag 50 or Promag 53 PROFIBUS PA must be used.
3. Connect the measuring device Promag 300 PROFIBUS PA.

If the factory setting had been changed on the replaced device (Promag 50 PROFIBUS PA or Promag 53 PROFIBUS PA), the following settings may need to be changed:

1. Configuration of the application-specific parameters.
2. Choice of process variables to be transmitted via the **Channel** parameter in the Analog Input or Totalizer function block.
3. Setting of the units for the process variables.

9.4 Using the GSD modules of the previous model

In the compatibility mode, all the modules already configured in the automation system are generally supported during cyclic data transmission. However, Promag 300 does not perform further processing for the following modules, i.e. the function is not executed:

- DISPLAY_VALUE
- BATCHING_QUANTITY
- BATCHING_FIX_COMP_QUANTITY

If the device is replaced, the Promag 300 device supports the compatibility of the cyclic data with previous models. It is not necessary to adjust the engineering parameters of the PROFIBUS network with the Promag 300 GSD file.

The diagnostic messages transmitted to the distributed control system with the GSD of the previous model may differ from the diagnostic messages of the device. The diagnostic messages of the device are critical.

9.4.1 Using the CONTROL_BLOCK module in the previous model

If the CONTROL_BLOCK module is used in the previous model, the control variables are processed further if relevant functionalities can be assigned for the Promag 300.

The functions are supported as follows depending on the previous model:

Previous model: Promag 50 PROFIBUS PA

Control variable	Function	Support
0 → 2	Positive zero return: ON	Yes
0 → 3	Positive zero return: OFF	Yes
0 → 8	Measuring mode: UNIDIRECTIONAL	No
0 → 9	Measuring mode: BIDIRECTIONAL	Cause: The Profile Transducer Block Flow is no longer supported. To continue to use the functionality: Use the Totalizer operation mode parameter in the Totalizer function block.
0 → 24	UNIT TO BUS	No Cause: Functionality is no longer required as the unit is adopted automatically.

Previous model: Promag 53 PROFIBUS PA

Control variable	Function	Support
0 → 2	Positive zero return: ON	Yes
0 → 3	Positive zero return: OFF	Yes

Control variable	Function	Support
0 → 5	Electrode cleaning circuit (ECC): OFF	Yes
0 → 6	Electrode cleaning circuit (ECC): ON	Yes
0 → 8	Measuring mode: UNIDIRECTIONAL	No
0 → 9	Measuring mode: BIDIRECTIONAL	<p>Cause: The Profile Transducer Block Flow is no longer supported.</p> <p>To continue to use the functionality: Use the Totalizer operation mode parameter in the Totalizer function block.</p>
0 → 24	UNIT TO BUS	<p>No</p> <p>Cause: Functionality is no longer required as the unit is adopted automatically.</p>

9.5 Cyclic data transmission

Cyclic data transmission when using the device master file (GSD).

9.5.1 Block model

The block model shows which input and output data the measuring device makes available for cyclic data exchange. Cyclic data exchange takes place with a PROFIBUS master (Class 1), e.g. a control system.

Measuring device			Control system
Flow Block	Analog Input block 1 to 4 → 85	Output value AI →	PROFIBUS PA
		Output value TOTAL →	
	Totalizer block 1 to 3 → 85	Controller SETTOT ←	
		Configuration MODETOT ←	
	Analog Output block 1 to 2 → 87	Input values AO ←	
	Discrete Input block 1 to 2 → 88	Output values DI →	
	Discrete Output block 1 to 3 → 88	Input values DO ←	

Defined order of modules

The measuring device works as a modular PROFIBUS slave. In contrast to a compact slave, a modular slave has a variable design and consists of several individual modules. The device master file (GSD) contains a description of the individual modules (input and output data) along with their individual properties.

The modules are permanently assigned to the slots, i.e. when configuring the modules, the order and the arrangement of the modules must be respected.

Slot	Module	Function block
1...4	AI	Analog Input block 1 to 4
5	TOTAL or SETTOT_TOTAL or SETTOT_MODETOT_TOTAL	Totalizer block 1
6		Totalizer block 2
7		Totalizer block 3
8...9	AO	Analog Output block 1 to 2
10...11	DI	Discrete Input block 1 to 2
12...14	DO	Discrete Output block 1 to 3

To optimize the data throughput rate of the PROFIBUS network, it is advisable to only configure modules that are processed in the PROFIBUS master system. If this results in gaps between the configured modules, these gaps must be assigned to the EMPTY_MODULE.

9.5.2 Description of the modules

The data structure is described from the perspective of the PROFIBUS master:

- Input data: Are sent from the measuring device to the PROFIBUS master.
- Output data: Are sent from the PROFIBUS master to the measuring device.

AI module (Analog Input)

Transmit an input variable from the measuring device to the PROFIBUS master (Class 1).

The selected input variable, along with the status, is cyclically transmitted to the PROFIBUS Master (Class 1) via the AI module. The input variable is depicted in the first four bytes in the form of a floating point number as per the IEEE 754 standard. The fifth byte contains standardized status information pertaining to the input variable.

Four Analog Input blocks are available (slot 1 to 4).

Selection: input variable

Input variable
Volume flow
Mass flow
Corrected volume flow
Flow velocity
Conductivity
Corrected conductivity
Temperature
Electronic temperature
Current input 1
Current input 2
Current input 3

Factory setting

Function block	Factory setting
AI 1	Volume flow
AI 2	Mass flow
AI 3	Corrected volume flow
AI 4	Flow velocity

Data structure

Input data of Analog Input

Byte 1	Byte 2	Byte 3	Byte 4	Byte 5
Measured value: floating point number (IEEE 754)				Status

TOTAL module

Transmit a totalizer value from the measuring device to the PROFIBUS master (Class 1).

A selected totalizer value, along with the status, is cyclically transmitted to a PROFIBUS Master (Class 1) via the TOTAL module. The totalizer value is depicted in the first four bytes in the form of a floating point number as per the IEEE 754 standard. The fifth byte contains standardized status information pertaining to the totalizer value.

Three Totalizer blocks are available (slot 5 to 7).

Selection: totalizer value

Input variable
Volume flow
Mass flow
Corrected volume flow

Data structure

Input data of TOTAL

Byte 1	Byte 2	Byte 3	Byte 4	Byte 5
Measured value: floating point number (IEEE 754)				Status

SETTOT_TOTAL module

The module combination consists of the SETTOT and TOTAL functions:

- SETTOT: Control the totalizers via the PROFIBUS master.
- TOTAL: Transmit totalizer value, along with the status, to the PROFIBUS master.

Three Totalizer blocks are available (slot 5 to 7).

Selection: control totalizer

Value SETTOT	Control totalizer
0	Totalize
1	Resetting
2	Adopt totalizer initial setting

Factory setting

Function block	Factory setting: Value SETTOT (meaning)
Totalizer 1, 2 and 3	0 (totalizing)

Data structure

Output data of SETTOT

Byte 1
Control variable 1

Input data of TOTAL

Byte 1	Byte 2	Byte 3	Byte 4	Byte 5
Measured value: floating point number (IEEE 754)				Status

SETTOT_MODETOT_TOTAL module

The module combination consists of the SETTOT, MODETOT and TOTAL functions:

- SETTOT: Control the totalizers via the PROFIBUS master.
- MODETOT: Configure the totalizers via the PROFIBUS master.
- TOTAL: Transmit totalizer value, along with the status, to the PROFIBUS master.

Three Totalizer blocks are available (slot 5 to 7).

Selection: totalizer configuration

MODETOT value	Totalizer configuration
0	Balancing
1	Balance the positive flow
2	Balance the negative flow
3	Stop totalizing

Factory setting

Function block	Factory setting: Value MODETOT (meaning)
Totalizer 1, 2 and 3	0 (balancing)

*Data structure**Output data of SETTOT and MODETOT*

Byte 1	Byte 2
Control variable 1: SETTOT	Control variable 2: MODETOT

Input data of TOTAL

Byte 1	Byte 2	Byte 3	Byte 4	Byte 5
Measured value: floating point number (IEEE 754)				Status

AO module (Analog Output)

Transmit a compensation value from the PROFIBUS master (Class 1) to the measuring device.

A compensation value, along with the status, is cyclically transmitted from the PROFIBUS Master (Class 1) to the measuring device via the AO module. The compensation value is depicted in the first four bytes in the form of a floating point number as per the IEEE 754 standard. The fifth byte contains standardized status information pertaining to the compensation value.

Two Analog Output blocks are available (slot 8 to 9).

Assigned compensation values

A compensation value is permanently assigned to the individual Analog Output blocks.

Function block	Compensation value
AO 1	External temperature ¹⁾
AO 2	External density

1) The compensation values must be transmitted to the device in the SI basic unit



The selection is made via: Expert → Sensor → External compensation

*Data structure**Output data of Analog Output*

Byte 1	Byte 2	Byte 3	Byte 4	Byte 5
Measured value: floating point number (IEEE 754)				Status

DI module (Discrete Input)

Transmit discrete input values from the measuring device to the PROFIBUS master (Class 1). Discrete input values are used by the measuring device to transmit the state of device functions to the PROFIBUS master (Class 1).

The DI module cyclically transmits the discrete input value, along with the status, to the PROFIBUS Master (Class 1). The discrete input value is depicted in the first byte. The second byte contains standardized status information pertaining to the input value.

Two Discrete Input blocks are available (slot 10 to 11).

Selection: device function

Device function	Factory setting: Status (meaning)
Empty pipe detection	<ul style="list-style-type: none"> ▪ 0 (device function not active) ▪ 1 (device function active)
Low flow cut off	
Status verification ¹⁾	<ul style="list-style-type: none"> ▪ Bit 0: Verification status - Check not done ▪ Bit 1: Verification status - Failed ▪ Bit 2: Verification status - Busy ▪ Bit 3: Verification status - Ready ▪ Bit 4: Verification overall result - Failed ▪ Bit 5: Verification overall result - Passed ▪ Bit 6: Verification overall result - Check not done ▪ Bit 7: Not used

1) Only available with the Heartbeat Verification application package

Factory setting

Function block	Factory setting
DI 1	Empty pipe detection
DI 2	Low flow cut off

*Data structure**Input data of Discrete Input*

Byte 1	Byte 2
Discrete	Status

DO module (Discrete Output)

Transmit discrete output values from the PROFIBUS master (Class 1) to the measuring device. Discrete output values are used by the PROFIBUS master (Class 1) to enable and disable device functions.

The DO module cyclically transmits the discrete output value, along with the status, to the measuring device. The discrete output value is depicted in the first byte. The second byte contains standardized status information pertaining to the output value.

Three Discrete Output blocks are available (slot 12 to 14).

Assigned device functions

A device function is permanently assigned to the individual Discrete Output blocks.

Function block	Device function	Values: control (meaning)
DO 1	Flow override	<ul style="list-style-type: none"> ▪ 0 (disable device function) ▪ 1 (enable device function)
DO 2	Start verification ¹⁾	
DO 3	Relay output or switch output of the pulse/frequency/switch output	<ul style="list-style-type: none"> ▪ 0 (non-conductive) ▪ 1 (conductive)

1) Only available with the Heartbeat Verification application package

*Data structure**Output data of Discrete Output*

Byte 1	Byte 2
Discrete	Status

EMPTY_MODULE module

This module is used to assign empty spaces arising from modules not being used in the slots .



The measuring device works as a modular PROFIBUS slave. In contrast to a compact slave, a modular PROFIBUS slave has a variable design and consists of several individual modules. The GSD file contains a description of the individual modules along with their individual properties.

The modules are permanently assigned to the slots. When configuring the modules, it is absolutely essential to observe the sequence/arrangement of the modules. Any gaps between the configured modules must be filled with the EMPTY_MODULE.

10 Commissioning



10.1 Function check

Before commissioning the measuring device:



- ▶ Make sure that the post-installation and post-connection checks have been performed.
 - "Post-installation check" checklist →  35
 - "Post-connection check" checklist →  51

10.2 Switching on the measuring device

- ▶ After a successful function check, switch on the measuring device.
 - ↳ After a successful startup, the local display switches automatically from the startup display to the operational display.

 If nothing appears on the local display or a diagnostic message is displayed, refer to the section on "Diagnostics and troubleshooting" →  139.

10.3 Connecting via FieldCare

- For FieldCare →  73 connection
- For connecting via FieldCare →  76
- For the FieldCare →  77 user interface

10.4 Configuring the device address via software

In the "**Communication**" submenu the device address can be set.



Navigation

"Setup" menu → Communication → Device address

10.4.1 PROFIBUS network

At time of delivery, the measuring device has the following factory setting:

Device address	126
----------------	-----

-  ▪ To display the current device address: **Device address** parameter →  94
- If hardware addressing is active, software addressing is blocked →  49

10.5 Setting the operating language

Factory setting: English or ordered local language

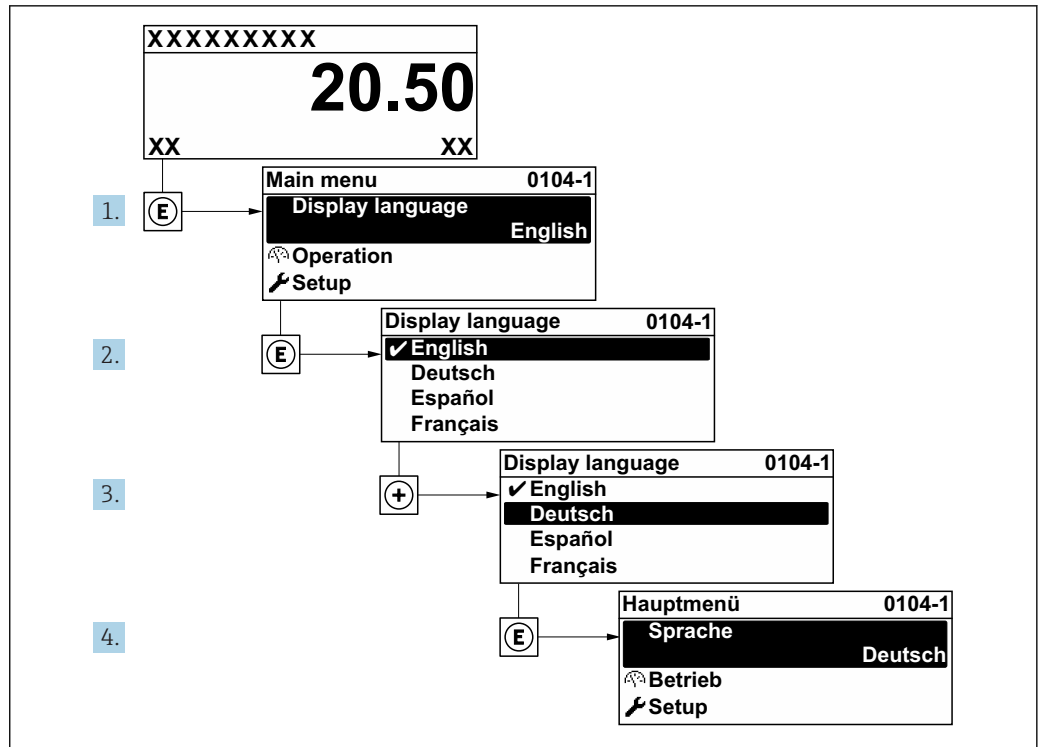

A0029420

26 Taking the example of the local display

10.6 Configuring the measuring device

- The **Setup** menu with its guided wizards contains all the parameters needed for standard operation.
- Navigation to the **Setup** menu

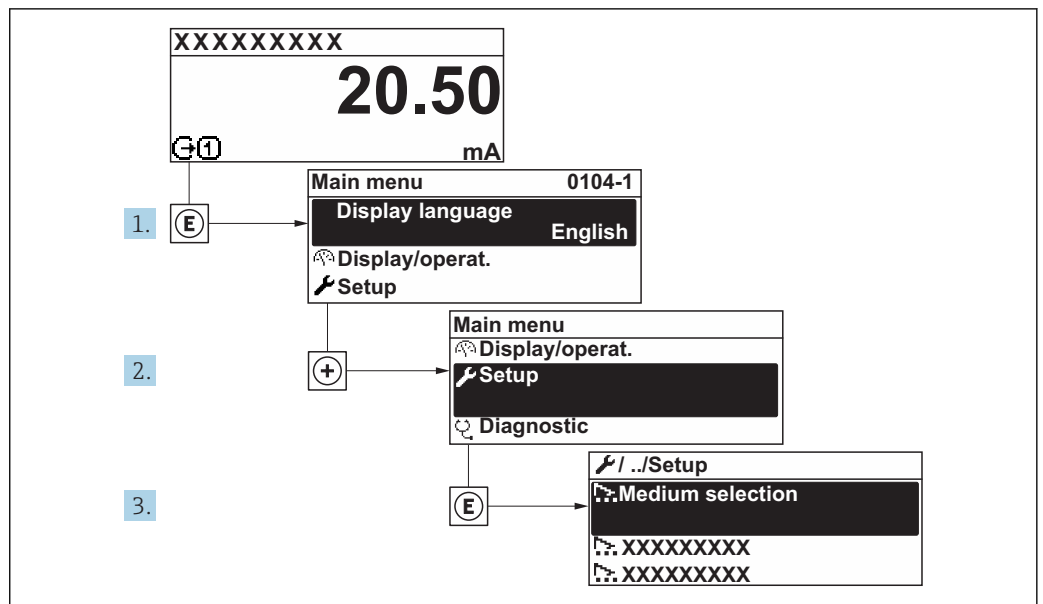

A003222-EN

27 Taking the example of the local display

i The number of submenus and parameters can vary depending on the device version. Certain submenus and parameters in these submenus are not described in the Operation Instructions. Instead a description is provided in the Special Documentation for the device (→ "Supplementary documentation" section).

Navigation

"Setup" menu

Setup	
Device tag	→ 93
▶ System units	→ 93
▶ Communication	→ 94
▶ Analog inputs	→ 95
▶ I/O configuration	→ 95
▶ Current input 1 to n	→ 96
▶ Status input 1 to n	→ 97
▶ Current output 1 to n	→ 98
▶ Pulse/frequency/switch output 1 to n	→ 101
▶ Relay output 1 to n	→ 107
▶ Display	→ 108
▶ Low flow cut off	→ 110
▶ Empty pipe detection	→ 111
▶ Advanced setup	→ 112

10.6.1 Defining the tag name

To enable fast identification of the measuring point within the system, you can enter a unique designation using the **Device tag** parameter and thus change the factory setting.

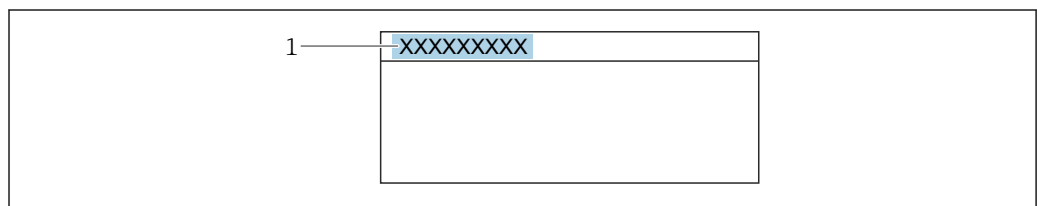

28 Header of the operational display with tag name

1 Tag name

 Enter the tag name in the "FieldCare" operating tool → 77

Navigation
 "Setup" menu → Device tag

Parameter overview with brief description

Parameter	Description	User entry	Factory setting
Device tag	Enter the name for the measuring point.	Max. 32 characters, such as letters, numbers or special characters (e.g. @, %, /).	Promag 300 PA







10.6.2 Setting the system units

In the **System units** submenu the units of all the measured values can be set.

 The number of submenus and parameters can vary depending on the device version. Certain submenus and parameters in these submenus are not described in the Operation Instructions. Instead a description is provided in the Special Documentation for the device (→ "Supplementary documentation" section).

Navigation
 "Setup" menu → System units

▶ System units

- Volume flow unit →  94
- Volume unit →  94
- Conductivity unit
- Temperature unit →  94
- Mass flow unit →  94
- Mass unit →  94
- Density unit →  94
- Corrected volume flow unit
- Corrected volume unit

Parameter overview with brief description

Parameter	Description	Selection	Factory setting
Volume flow unit	Select volume flow unit. <i>Result</i> The selected unit applies for: <ul style="list-style-type: none"> ▪ Output ▪ Low flow cut off ▪ Simulation process variable 	Unit choose list	Country-specific: <ul style="list-style-type: none"> ▪ l/h ▪ gal/min (us)
Volume unit	Select volume unit.	Unit choose list	Country-specific: <ul style="list-style-type: none"> ▪ m³ ▪ gal (us)
Temperature unit	Select temperature unit. <i>Result</i> The selected unit applies for: <ul style="list-style-type: none"> ▪ Temperature parameter ▪ Maximum value parameter ▪ Minimum value parameter ▪ External temperature parameter ▪ Maximum value parameter ▪ Minimum value parameter 	Unit choose list	Country-specific: <ul style="list-style-type: none"> ▪ °C ▪ °F
Mass flow unit	Select mass flow unit. <i>Result</i> The selected unit applies for: <ul style="list-style-type: none"> ▪ Output ▪ Low flow cut off ▪ Simulation process variable 	Unit choose list	Country-specific: <ul style="list-style-type: none"> ▪ kg/h ▪ lb/min
Mass unit	Select mass unit.	Unit choose list	Country-specific: <ul style="list-style-type: none"> ▪ kg ▪ lb
Density unit	Select density unit. <i>Result</i> The selected unit applies for: <ul style="list-style-type: none"> ▪ Output ▪ Simulation process variable 	Unit choose list	Country-specific: <ul style="list-style-type: none"> ▪ kg/l ▪ lb/ft³

10.6.3 Configuring communication interface

The **Communication** submenu guides you systematically through all the parameters that have to be configured for selecting and setting the communication interface.

Navigation

"Setup" menu → Communication

▶ Communication

→ 94

Parameter overview with brief description

Parameter	Description	User entry	Factory setting
Device address	Enter device address.	0 to 126	126

10.6.4 Configuring the analog inputs

The **Analog inputs** submenu guides the user systematically to the individual **Analog input 1 to n** submenu. From here you get to the parameters of the individual analog input.

Navigation

"Setup" menu → Analog inputs

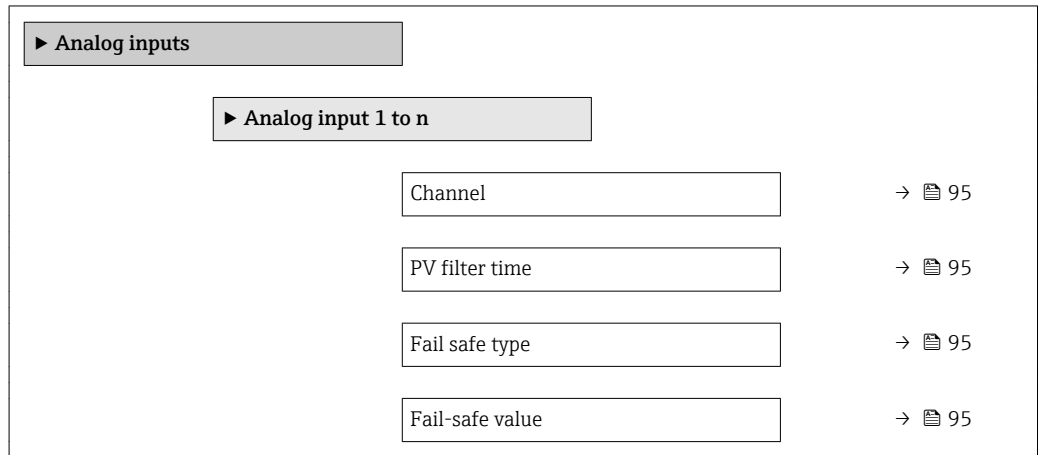

Parameter overview with brief description

Parameter	Prerequisite	Description	Selection / User entry	Factory setting
Channel	–	Select the process variable.	<ul style="list-style-type: none"> ■ Volume flow ■ Mass flow ■ Corrected volume flow ■ Flow velocity ■ Conductivity* ■ Corrected conductivity* ■ Temperature ■ Electronic temperature ■ Current input 1* ■ Current input 2* ■ Current input 3* 	Volume flow
PV filter time	–	Specify the time to suppress signal peaks. During the specified time the analog input does not respond to an erratic increase in the process variable.	Positive floating-point number	0
Fail safe type	–	Select the failure mode.	<ul style="list-style-type: none"> ■ Fail-safe value ■ Fallback value ■ Off 	Off
Fail-safe value	In Fail safe type parameter, the Fail-safe value option is selected.	Specify the values to be output when an error occurs.	Signed floating-point number	0

* Visibility depends on order options or device settings

10.6.5 Displaying the I/O configuration

The **I/O configuration** submenu guides the user systematically through all the parameters in which the configuration of the I/O modules is displayed.

Navigation

"Setup" menu → I/O configuration

▶ I/O configuration

I/O module 1 to n terminal numbers	→ 96
I/O module 1 to n information	→ 96
I/O module 1 to n type	→ 96
Apply I/O configuration	→ 96
Alteration code	→ 96

Parameter overview with brief description

Parameter	Description	User interface / Selection / User entry	Factory setting
I/O module 1 to n terminal numbers	Shows the terminal numbers used by the I/O module.	<ul style="list-style-type: none"> ▪ Not used ▪ 26-27 (I/O 1) ▪ 24-25 (I/O 2) 	–
I/O module 1 to n information	Shows information of the plugged I/O module.	<ul style="list-style-type: none"> ▪ Not plugged ▪ Invalid ▪ Not configurable ▪ Configurable ▪ Profibus PA 	–
I/O module 1 to n type	Shows the I/O module type.	<ul style="list-style-type: none"> ▪ Off ▪ Current output * ▪ Current input * ▪ Status input * ▪ Pulse/frequency/switch output * ▪ Double pulse output * ▪ Relay output * 	Off
Apply I/O configuration	Apply parameterization of the freely configurable I/O module.	<ul style="list-style-type: none"> ▪ No ▪ Yes 	No
Alteration code	Enter the code in order to change the I/O configuration.	Positive integer	0

* Visibility depends on order options or device settings

10.6.6 Configuring the current input

The "Current input" wizard guides the user systematically through all the parameters that have to be set for configuring the current input.

Navigation

"Setup" menu → Current input

▶ Current input 1 to n

Terminal number	→ 97
-----------------	-------

Signal mode	→ 97
0/4 mA value	→ 97
20 mA value	→ 97
Current span	→ 97
Failure mode	→ 97
Failure value	→ 97

Parameter overview with brief description

Parameter	Prerequisite	Description	User interface / Selection / User entry	Factory setting
Terminal number	–	Shows the terminal numbers used by the current input module.	<ul style="list-style-type: none"> Not used 24-25 (I/O 2) 	–
Signal mode	The measuring device is not approved for use in the hazardous area with type of protection Ex-i.	Select the signal mode for the current input.	<ul style="list-style-type: none"> Passive Active * 	Active
0/4 mA value	–	Enter 4 mA value.	Signed floating-point number	0
20 mA value	–	Enter 20 mA value.	Signed floating-point number	Depends on country and nominal diameter
Current span	–	Select current range for process value output and upper/lower level for alarm signal.	<ul style="list-style-type: none"> 4...20 mA 4...20 mA NAMUR 4...20 mA US 0...20 mA 	Country-specific: <ul style="list-style-type: none"> 4...20 mA NAMUR 4...20 mA US
Failure mode	–	Define input behavior in alarm condition.	<ul style="list-style-type: none"> Alarm Last valid value Defined value 	Alarm
Failure value	In the Failure mode parameter, the Defined value option is selected.	Enter value to be used by the device if input value from external device is missing.	Signed floating-point number	0

* Visibility depends on order options or device settings

10.6.7 Configuring the status input

The **Status input** submenu guides the user systematically through all the parameters that have to be set for configuring the status input.

Navigation

"Setup" menu → Status input

► Status input 1 to n	
Assign status input	→ 98

Terminal number	→ 98
Active level	→ 98
Terminal number	→ 98
Response time status input	→ 98
Terminal number	→ 98

Parameter overview with brief description

Parameter	Description	User interface / Selection / User entry	Factory setting
Terminal number	Shows the terminal numbers used by the status input module.	<ul style="list-style-type: none"> ▪ Not used ▪ 24-25 (I/O 2) 	–
Assign status input	Select function for the status input.	<ul style="list-style-type: none"> ▪ Off ▪ Reset totalizer 1 ▪ Reset totalizer 2 ▪ Reset totalizer 3 ▪ Reset all totalizers ▪ Flow override 	Off
Active level	Define input signal level at which the assigned function is triggered.	<ul style="list-style-type: none"> ▪ High ▪ Low 	High
Response time status input	Define the minimum amount of time the input signal level must be present before the selected function is triggered.	5 to 200 ms	50 ms

10.6.8 Configuring the current output

The **Current output** wizard guides you systematically through all the parameters that have to be set for configuring the current output.

Navigation

"Setup" menu → Current output

▶ Current output 1 to n	
Terminal number	→ 99
Signal mode	→ 99
Assign current output 1 to n	→ 99
Current span	→ 99
0/4 mA value	→ 99
20 mA value	→ 99
Fixed current	→ 99

Damping output 1 to n	→ ⓘ 99
Failure mode	→ ⓘ 100
Failure current	→ ⓘ 100

Parameter overview with brief description

Parameter	Prerequisite	Description	User interface / Selection / User entry	Factory setting
Terminal number	–	Shows the terminal numbers used by the current output module.	<ul style="list-style-type: none"> ■ Not used ■ 24-25 (I/O 2) 	–
Signal mode	–	Select the signal mode for the current output.	<ul style="list-style-type: none"> ■ Passive * ■ Active * 	Active
Assign current output 1 to n	–	Select process variable for current output.	<ul style="list-style-type: none"> ■ Off * ■ Volume flow ■ Mass flow ■ Corrected volume flow ■ Flow velocity * ■ Conductivity * ■ Electronic temperature 	Volume flow
Current span	–	Select current range for process value output and upper/lower level for alarm signal.	<ul style="list-style-type: none"> ■ 4...20 mA NAMUR ■ 4...20 mA US ■ 4...20 mA ■ 0...20 mA ■ Fixed current 	Country-specific: <ul style="list-style-type: none"> ■ 4...20 mA NAMUR ■ 4...20 mA US
0/4 mA value	In the Current span parameter (→ ⓘ 99), one of the following options is selected: <ul style="list-style-type: none"> ■ 4...20 mA NAMUR ■ 4...20 mA US ■ 4...20 mA ■ 0...20 mA 	Enter 4 mA value.	Signed floating-point number	Country-specific: <ul style="list-style-type: none"> ■ 0 l/h ■ 0 gal/min (us)
20 mA value	One of the following options is selected in the Current span parameter (→ ⓘ 99): <ul style="list-style-type: none"> ■ 4...20 mA NAMUR ■ 4...20 mA US ■ 4...20 mA ■ 0...20 mA 	Enter 20 mA value.	Signed floating-point number	Depends on country and nominal diameter
Fixed current	The Fixed current option is selected in the Current span parameter (→ ⓘ 99).	Defines the fixed output current.	0 to 22.5 mA	22.5 mA
Damping output 1 to n	A process variable is selected in the Assign current output parameter (→ ⓘ 99) and one of the following options is selected in the Current span parameter (→ ⓘ 99): <ul style="list-style-type: none"> ■ 4...20 mA NAMUR ■ 4...20 mA US ■ 4...20 mA ■ 0...20 mA 	Set reaction time for output signal to fluctuations in the measured value.	0.0 to 999.9 s	1.0 s

Parameter	Prerequisite	Description	User interface / Selection / User entry	Factory setting
Failure mode	A process variable is selected in the Assign current output parameter (→ 99) and one of the following options is selected in the Current span parameter (→ 99): <ul style="list-style-type: none"> ▪ 4...20 mA NAMUR ▪ 4...20 mA US ▪ 4...20 mA ▪ 0...20 mA 	Define output behavior in alarm condition.	<ul style="list-style-type: none"> ▪ Min. ▪ Max. ▪ Last valid value ▪ Actual value ▪ Defined value 	Max.
Failure current	The Defined value option is selected in the Failure mode parameter.	Enter current output value in alarm condition.	0 to 22.5 mA	22.5 mA

* Visibility depends on order options or device settings

10.6.9 Configuring the pulse/frequency/switch output

The **Pulse/frequency/switch output** wizard guides you systematically through all the parameters that can be set for configuring the selected output type.

Navigation

"Setup" menu → Advanced setup → Pulse/frequency/switch output

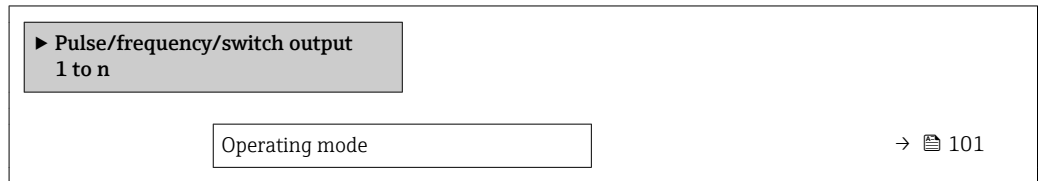

Parameter overview with brief description

Parameter	Description	Selection	Factory setting
Operating mode	Define the output as a pulse, frequency or switch output.	<ul style="list-style-type: none"> ■ Pulse ■ Frequency ■ Switch 	Pulse





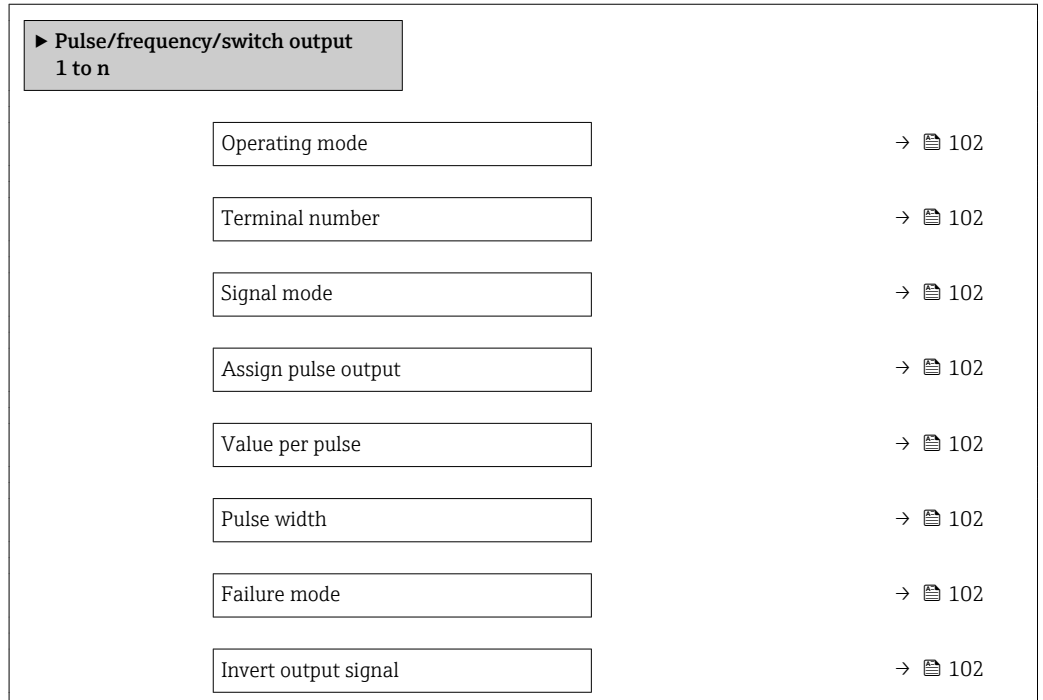

Configuring the pulse output

Navigation

"Setup" menu → Pulse/frequency/switch output







Parameter overview with brief description







Parameter	Prerequisite	Description	Selection / User interface / User entry	Factory setting
Operating mode	–	Define the output as a pulse, frequency or switch output.	<ul style="list-style-type: none"> ▪ Pulse ▪ Frequency ▪ Switch 	Pulse
Terminal number	–	Shows the terminal numbers used by the PFS output module.	<ul style="list-style-type: none"> ▪ Not used ▪ 24-25 (I/O 2) 	–
Signal mode	–	Select the signal mode for the PFS output.	<ul style="list-style-type: none"> ▪ Passive ▪ Active 	Passive
Assign pulse output 1 to n	The Pulse option is selected in the Operating mode parameter.	Select process variable for pulse output.	<ul style="list-style-type: none"> ▪ Off ▪ Volume flow ▪ Mass flow ▪ Corrected volume flow 	Off
Value per pulse	The Pulse option is selected in the Operating mode parameter (→  101) and a process variable is selected in the Assign pulse output parameter (→  102).	Enter measured value at which a pulse is output.	Positive floating point number	Depends on country and nominal diameter
Pulse width	The Pulse option is selected in the Operating mode parameter (→  101) and a process variable is selected in the Assign pulse output parameter (→  102).	Define time width of the output pulse.	0.05 to 2 000 ms	100 ms
Failure mode	The Pulse option is selected in the Operating mode parameter (→  101) and a process variable is selected in the Assign pulse output parameter (→  102).	Define output behavior in alarm condition.	<ul style="list-style-type: none"> ▪ Actual value ▪ No pulses 	No pulses
Invert output signal	–	Invert the output signal.	<ul style="list-style-type: none"> ▪ No ▪ Yes 	No

Configuring the frequency output







Navigation

"Setup" menu → Pulse/frequency/switch output

▶ Pulse/frequency/switch output 1 to n	
Operating mode	→  103
Terminal number	→  103
Signal mode	→  103
Assign frequency output	→  103
Minimum frequency value	→  103

Maximum frequency value	→  103
Measuring value at minimum frequency	→  103
Measuring value at maximum frequency	→  104
Failure mode	→  104
Failure frequency	→  104
Invert output signal	→  104

Parameter overview with brief description

Parameter	Prerequisite	Description	Selection / User interface / User entry	Factory setting
Operating mode	–	Define the output as a pulse, frequency or switch output.	<ul style="list-style-type: none"> ▪ Pulse ▪ Frequency ▪ Switch 	Pulse
Terminal number	–	Shows the terminal numbers used by the PFS output module.	<ul style="list-style-type: none"> ▪ Not used ▪ 24-25 (I/O 2) 	–
Signal mode	–	Select the signal mode for the PFS output.	<ul style="list-style-type: none"> ▪ Passive ▪ Active 	Passive
Assign frequency output	The Frequency option is selected in the Operating mode parameter (→  101).	Select process variable for frequency output.	<ul style="list-style-type: none"> ▪ Off ▪ Volume flow ▪ Mass flow ▪ Corrected volume flow ▪ Flow velocity ▪ Conductivity* ▪ Electronic temperature 	Off
Minimum frequency value	The Frequency option is selected in the Operating mode parameter (→  101) and a process variable is selected in the Assign frequency output parameter (→  103).	Enter minimum frequency.	0.0 to 10000.0 Hz	0.0 Hz
Maximum frequency value	The Frequency option is selected in the Operating mode parameter (→  101) and a process variable is selected in the Assign frequency output parameter (→  103).	Enter maximum frequency.	0.0 to 10000.0 Hz	10000.0 Hz
Measuring value at minimum frequency	The Frequency option is selected in the Operating mode parameter (→  101) and a process variable is selected in the Assign frequency output parameter (→  103).	Enter measured value for minimum frequency.	Signed floating-point number	Depends on country and nominal diameter

Parameter	Prerequisite	Description	Selection / User interface / User entry	Factory setting
Measuring value at maximum frequency	The Frequency option is selected in the Operating mode parameter (→ 101) and a process variable is selected in the Assign frequency output parameter (→ 103).	Enter measured value for maximum frequency.	Signed floating-point number	Depends on country and nominal diameter
Failure mode	The Frequency option is selected in the Operating mode parameter (→ 101) and a process variable is selected in the Assign frequency output parameter (→ 103).	Define output behavior in alarm condition.	<ul style="list-style-type: none"> ▪ Actual value ▪ Defined value ▪ 0 Hz 	0 Hz
Failure frequency	The Frequency option is selected in the Operating mode parameter (→ 101) and a process variable is selected in the Assign frequency output parameter (→ 103).	Enter frequency output value in alarm condition.	0.0 to 12 500.0 Hz	0.0 Hz
Invert output signal	–	Invert the output signal.	<ul style="list-style-type: none"> ▪ No ▪ Yes 	No

* Visibility depends on order options or device settings

Configuring the switch output

Navigation

"Setup" menu → Pulse/frequency/switch output

► Pulse/frequency/switch output 1 to n	
Operating mode	→ 105
Terminal number	→ 105
Signal mode	→ 105
Switch output function	→ 106
Assign diagnostic behavior	→ 106
Assign limit	→ 106
Assign flow direction check	→ 106
Assign status	→ 106
Switch-on value	→ 106
Switch-off value	→ 106
Switch-on delay	→ 106
Switch-off delay	→ 107
Failure mode	→ 107
Invert output signal	→ 107

Parameter overview with brief description

Parameter	Prerequisite	Description	Selection / User interface / User entry	Factory setting
Operating mode	–	Define the output as a pulse, frequency or switch output.	<ul style="list-style-type: none"> ■ Pulse ■ Frequency ■ Switch 	Pulse
Terminal number	–	Shows the terminal numbers used by the PFS output module.	<ul style="list-style-type: none"> ■ Not used ■ 24-25 (I/O 2) 	–
Signal mode	–	Select the signal mode for the PFS output.	<ul style="list-style-type: none"> ■ Passive ■ Active 	Passive

Parameter	Prerequisite	Description	Selection / User interface / User entry	Factory setting
Switch output function	The Switch option is selected in the Operating mode parameter.	Select function for switch output.	<ul style="list-style-type: none"> ▪ Off ▪ On ▪ Diagnostic behavior ▪ Limit ▪ Flow direction check ▪ Status 	Off
Assign diagnostic behavior	<ul style="list-style-type: none"> ▪ In the Operating mode parameter, the Switch option is selected. ▪ In the Switch output function parameter, the Diagnostic behavior option is selected. 	Select diagnostic behavior for switch output.	<ul style="list-style-type: none"> ▪ Alarm ▪ Alarm or warning ▪ Warning 	Alarm
Assign limit	<ul style="list-style-type: none"> ▪ The Switch option is selected in the Operating mode parameter. ▪ The Limit option is selected in the Switch output function parameter. 	Select process variable for limit function.	<ul style="list-style-type: none"> ▪ Off ▪ Volume flow ▪ Mass flow ▪ Corrected volume flow ▪ Flow velocity* ▪ Conductivity* ▪ Totalizer 1 ▪ Totalizer 2 ▪ Totalizer 3 ▪ Electronic temperature 	Volume flow
Assign flow direction check	<ul style="list-style-type: none"> ▪ The Switch option is selected in the Operating mode parameter. ▪ The Flow direction check option is selected in the Switch output function parameter. 	Select process variable for flow direction monitoring.	<ul style="list-style-type: none"> ▪ Off ▪ Volume flow ▪ Mass flow ▪ Corrected volume flow 	Volume flow
Assign status	<ul style="list-style-type: none"> ▪ The Switch option is selected in the Operating mode parameter. ▪ The Status option is selected in the Switch output function parameter. 	Select device status for switch output.	<ul style="list-style-type: none"> ▪ Partially filled pipe detection ▪ Low flow cut off* ▪ Digital output 3* 	Partially filled pipe detection
Switch-on value	<ul style="list-style-type: none"> ▪ The Switch option is selected in the Operating mode parameter. ▪ The Limit option is selected in the Switch output function parameter. 	Enter measured value for the switch-on point.	Signed floating-point number	Country-specific: <ul style="list-style-type: none"> ▪ 0 l/h ▪ 0 gal/min (us)
Switch-off value	<ul style="list-style-type: none"> ▪ The Switch option is selected in the Operating mode parameter. ▪ The Limit option is selected in the Switch output function parameter. 	Enter measured value for the switch-off point.	Signed floating-point number	Country-specific: <ul style="list-style-type: none"> ▪ 0 l/h ▪ 0 gal/min (us)
Switch-on delay	<ul style="list-style-type: none"> ▪ The Switch option is selected in the Operating mode parameter. ▪ The Limit option is selected in the Switch output function parameter. 	Define delay for the switch-on of status output.	0.0 to 100.0 s	0.0 s

Parameter	Prerequisite	Description	Selection / User interface / User entry	Factory setting
Switch-off delay	<ul style="list-style-type: none"> ▪ The Switch option is selected in the Operating mode parameter. ▪ The Limit option is selected in the Switch output function parameter. 	Define delay for the switch-off of status output.	0.0 to 100.0 s	0.0 s
Failure mode	–	Define output behavior in alarm condition.	<ul style="list-style-type: none"> ▪ Actual status ▪ Open ▪ Closed 	Open
Invert output signal	–	Invert the output signal.	<ul style="list-style-type: none"> ▪ No ▪ Yes 	No

* Visibility depends on order options or device settings

10.6.10 Configuring the relay output

The **Relay output** wizard guides the user systematically through all the parameters that have to be set for configuring the relay output.

Navigation

"Setup" menu → Relay output 1 to n

▶ RelaisOutput 1 to n

Switch output function	→ ⓘ 108
Assign flow direction check	→ ⓘ 108
Assign limit	→ ⓘ 108
Assign diagnostic behavior	→ ⓘ 108
Assign status	→ ⓘ 108
Switch-off value	→ ⓘ 108
Switch-on value	→ ⓘ 108
Failure mode	→ ⓘ 108

Parameter overview with brief description

Parameter	Prerequisite	Description	Selection / User interface / User entry	Factory setting
Relay output function	–	Select the function for the relay output.	<ul style="list-style-type: none"> ▪ Closed ▪ Open ▪ Diagnostic behavior ▪ Limit ▪ Flow direction check ▪ Digital Output 	Closed
Terminal number	–	Shows the terminal numbers used by the relay output module.	<ul style="list-style-type: none"> ▪ Not used ▪ 24-25 (I/O 2) 	–
Assign flow direction check	In the Relay output function parameter, the Flow direction check option is selected.	Select process variable for flow direction monitoring.	<ul style="list-style-type: none"> ▪ Off ▪ Volume flow ▪ Mass flow ▪ Corrected volume flow 	Volume flow
Assign limit	The Limit option is selected in the Relay output function parameter.	Select process variable for limit function.	<ul style="list-style-type: none"> ▪ Off ▪ Volume flow ▪ Mass flow ▪ Corrected volume flow ▪ Flow velocity[*] ▪ Conductivity[*] ▪ Totalizer 1 ▪ Totalizer 2 ▪ Totalizer 3 ▪ Electronic temperature 	Volume flow
Assign diagnostic behavior	In the Relay output function parameter, the Diagnostic behavior option is selected.	Select diagnostic behavior for switch output.	<ul style="list-style-type: none"> ▪ Alarm ▪ Alarm or warning ▪ Warning 	Alarm
Assign status	In the Relay output function parameter, the Digital Output option is selected.	Select device status for switch output.	<ul style="list-style-type: none"> ▪ Partially filled pipe detection ▪ Low flow cut off ▪ Digital output 3[*] 	Partially filled pipe detection
Switch-off value	In the Relay output function parameter, the Limit option is selected.	Enter measured value for the switch-off point.	Signed floating-point number	Country-specific: <ul style="list-style-type: none"> ▪ 0 l/h ▪ 0 gal(us)/min
Switch-off delay	In the Relay output function parameter, the Limit option is selected.	Define delay for the switch-off of status output.	0.0 to 100.0 s	0.0 s
Switch-on value	The Limit option is selected in the Relay output function parameter.	Enter measured value for the switch-on point.	Signed floating-point number	Country-specific: <ul style="list-style-type: none"> ▪ 0 l/h ▪ 0 gal(us)/min
Switch-on delay	In the Relay output function parameter, the Limit option is selected.	Define delay for the switch-on of status output.	0.0 to 100.0 s	0.0 s
Failure mode	–	Define output behavior in alarm condition.	<ul style="list-style-type: none"> ▪ Actual status ▪ Open ▪ Closed 	Open

* Visibility depends on order options or device settings

10.6.11 Configuring the local display



The **Display** wizard guides you systematically through all the parameters that can be configured for configuring the local display.

Navigation
 "Setup" menu → Display

▶ Display		
Format display		→ 109
Value 1 display		→ 109
0% bargraph value 1		→ 109
100% bargraph value 1		→ 109
Value 2 display		→ 109
Value 3 display		→ 110
0% bargraph value 3		→ 110
100% bargraph value 3		→ 110
Value 4 display		→ 110

Parameter overview with brief description

Parameter	Prerequisite	Description	Selection / User entry	Factory setting
Format display	A local display is provided.	Select how measured values are shown on the display.	<ul style="list-style-type: none"> ■ 1 value, max. size ■ 1 bargraph + 1 value ■ 2 values ■ 1 value large + 2 values ■ 4 values 	1 value, max. size
Value 1 display	A local display is provided.	Select the measured value that is shown on the local display.	<ul style="list-style-type: none"> ■ Volume flow ■ Mass flow ■ Corrected volume flow ■ Flow velocity ■ Totalizer 1 ■ Totalizer 2 ■ Totalizer 3 ■ Current output 1 * ■ Electronic temperature 	Volume flow
0% bargraph value 1	A local display is provided.	Enter 0% value for bar graph display.	Signed floating-point number	Country-specific: <ul style="list-style-type: none"> ■ 0 l/h ■ 0 gal/min (us)
100% bargraph value 1	A local display is provided.	Enter 100% value for bar graph display.	Signed floating-point number	Depends on country and nominal diameter
Value 2 display	A local display is provided.	Select the measured value that is shown on the local display.	For the picklist, see the Value 1 display parameter (→ 109)	None

Parameter	Prerequisite	Description	Selection / User entry	Factory setting
Value 3 display	A local display is provided.	Select the measured value that is shown on the local display.	For the picklist, see the Value 1 display parameter (→  109)	None
0% bargraph value 3	A selection was made in the Value 3 display parameter.	Enter 0% value for bar graph display.	Signed floating-point number	Country-specific: <ul style="list-style-type: none"> ■ 0 l/h ■ 0 gal/min (us)
100% bargraph value 3	A selection was made in the Value 3 display parameter.	Enter 100% value for bar graph display.	Signed floating-point number	0
Value 4 display	A local display is provided.	Select the measured value that is shown on the local display.	For the picklist, see the Value 1 display parameter (→  109)	None





* Visibility depends on order options or device settings

10.6.12 Configuring the low flow cut off



The **Low flow cut off** wizard systematically guides the user through all the parameters that must be set to configure low flow cut off.

Navigation

"Setup" menu → Low flow cut off

▶ Low flow cut off	
Assign process variable	→  110
On value low flow cutoff	→  110
Off value low flow cutoff	→  110
Pressure shock suppression	→  110

Parameter overview with brief description

Parameter	Prerequisite	Description	Selection / User entry	Factory setting
Assign process variable	–	Select process variable for low flow cut off.	<ul style="list-style-type: none"> ■ Off ■ Volume flow ■ Mass flow ■ Corrected volume flow 	Volume flow
On value low flow cutoff	A process variable is selected in the Assign process variable parameter (→  110).	Enter on value for low flow cut off.	Positive floating-point number	Depends on country and nominal diameter
Off value low flow cutoff	A process variable is selected in the Assign process variable parameter (→  110).	Enter off value for low flow cut off.	0 to 100.0 %	50 %
Pressure shock suppression	A process variable is selected in the Assign process variable parameter (→  110).	Enter time frame for signal suppression (= active pressure shock suppression).	0 to 100 s	0 s

10.6.13 Configuring empty pipe detection

The **Empty pipe detection** submenu contains parameters that must be configured for the configuration of empty pipe detection.

Navigation

"Setup" menu → Empty pipe detection

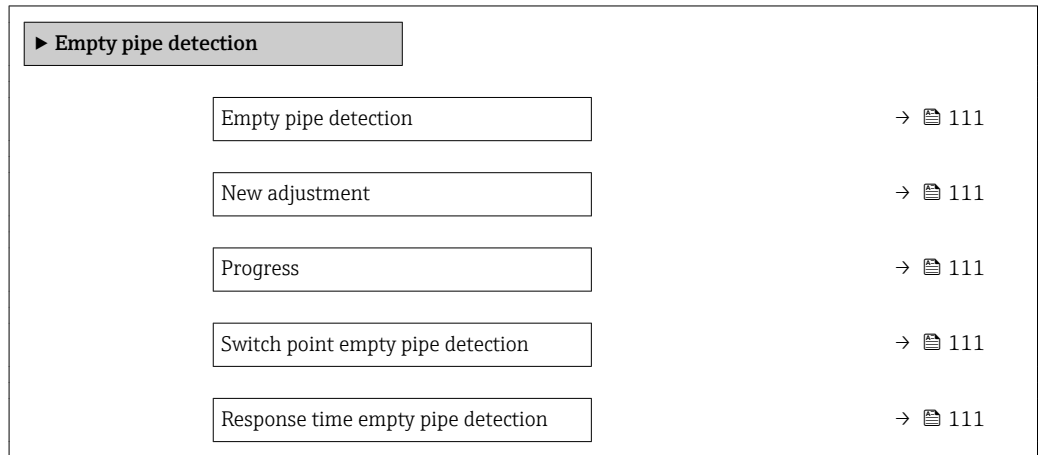

Parameter overview with brief description

Parameter	Prerequisite	Description	Selection / User interface / User entry	Factory setting
Empty pipe detection	–	Switch empty pipe detection on and off.	<ul style="list-style-type: none"> ■ Off ■ On 	Off
New adjustment	The On option is selected in the Empty pipe detection parameter.	Select type of adjustment.	<ul style="list-style-type: none"> ■ Cancel ■ Empty pipe adjust ■ Full pipe adjust 	Cancel
Progress	The On option is selected in the Empty pipe detection parameter.	Shows the progress.	<ul style="list-style-type: none"> ■ Ok ■ Busy ■ Not ok 	–
Switch point empty pipe detection	The On option is selected in the Empty pipe detection parameter.	Enter hysteresis in %, below this value the measuring tube will detected as empty.	0 to 100 %	50 %
Response time empty pipe detection	A process variable is selected in the Assign process variable parameter (→ 111).	Enter the time before diagnostic message S862 'Pipe empty' is displayed for empty pipe detection.	0 to 100 s	1 s

10.7 Advanced settings

The **Advanced setup** submenu together with its submenus contains parameters for specific settings.

Navigation to the "Advanced setup" submenu

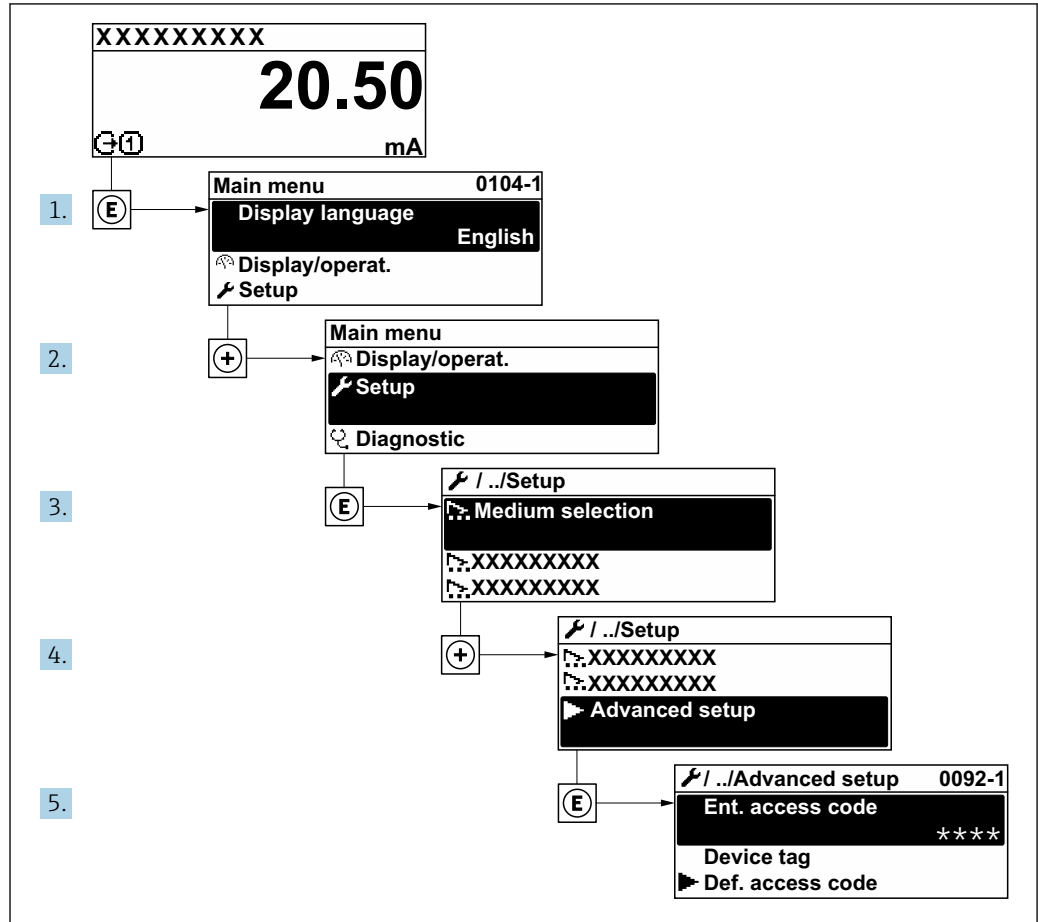

A0032223-EN

i The number of submenus and parameters can vary depending on the device version. Certain submenus and parameters in these submenus are not described in the Operation Instructions. Instead a description is provided in the Special Documentation for the device (→ "Supplementary documentation" section).

Navigation

"Setup" menu → Advanced setup

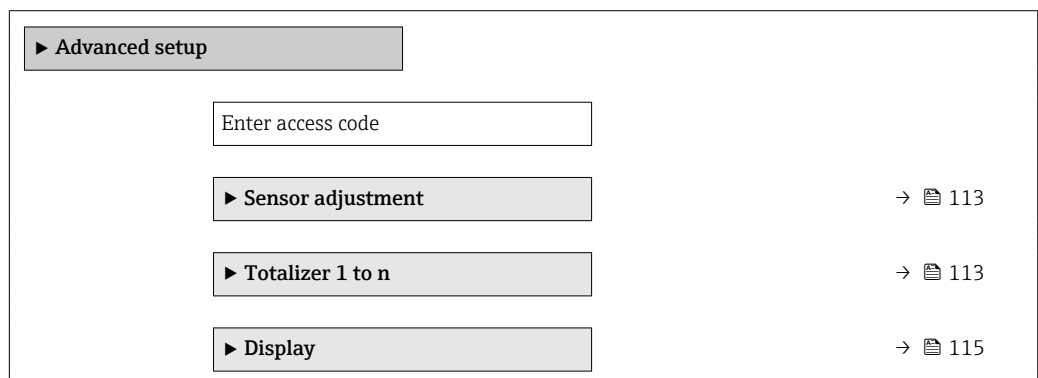

▶ Electrode cleaning circuit	→ 118
▶ WLAN settings	→ 118
▶ Heartbeat setup	
▶ Configuration backup	→ 120
▶ Administration	→ 121

10.7.1 Carrying out a sensor adjustment

The **Sensor adjustment** submenu contains parameters that pertain to the functionality of the sensor.

Navigation

"Setup" menu → Advanced setup → Sensor adjustment

▶ Sensor adjustment	
Installation direction	→ 113

Parameter overview with brief description

Parameter	Description	Selection	Factory setting
Installation direction	Set sign of flow direction to match the direction of the arrow on the sensor.	<ul style="list-style-type: none"> ▪ Flow in arrow direction ▪ Flow against arrow direction 	Flow in arrow direction

10.7.2 Configuring the totalizer

In the **"Totalizer 1 to n"** submenu the individual totalizer can be configured.

Navigation

"Setup" menu → Advanced setup → Totalizer 1 to n

▶ Totalizer 1 to n	
Assign process variable	→ 114
Unit totalizer	→ 114
Totalizer operation mode	→ 114
Control Totalizer 1 to n	→ 114
Failure mode	→ 114

Parameter overview with brief description

Parameter	Description	Selection	Factory setting
Assign process variable	Select process variable for totalizer.	<ul style="list-style-type: none"> ■ Volume flow ■ Mass flow ■ Corrected volume flow 	Volume flow
Unit totalizer	Select the unit for the process variable of the totalizer.	Unit choose list	Country-specific: <ul style="list-style-type: none"> ■ m³ ■ ft³
Control Totalizer 1 to n	Control totalizer value.	<ul style="list-style-type: none"> ■ Totalize ■ Reset + hold ■ Preset + hold 	Totalize
Totalizer operation mode	Select totalizer calculation mode.	<ul style="list-style-type: none"> ■ Net flow total ■ Forward flow total ■ Reverse flow total ■ Last valid value 	Net flow total
Failure mode	Define the totalizer behavior in the event of a device alarm.	<ul style="list-style-type: none"> ■ Stop ■ Actual value ■ Last valid value 	Actual value

10.7.3 Carrying out additional display configurations



In the **Display** submenu you can set all the parameters associated with the configuration of the local display.

Navigation

"Setup" menu → Advanced setup → Display

► Display	
Format display	→ 116
Value 1 display	→ 116
0% bargraph value 1	→ 116
100% bargraph value 1	→ 116
Decimal places 1	→ 116
Value 2 display	→ 116
Decimal places 2	→ 116
Value 3 display	→ 116
0% bargraph value 3	→ 116
100% bargraph value 3	→ 116
Decimal places 3	→ 116
Value 4 display	→ 116
Decimal places 4	→ 117
Display language	→ 117
Display interval	→ 117
Display damping	→ 117
Header	→ 117
Header text	→ 117
Separator	→ 117
Backlight	→ 117

Parameter overview with brief description

Parameter	Prerequisite	Description	Selection / User entry	Factory setting
Format display	A local display is provided.	Select how measured values are shown on the display.	<ul style="list-style-type: none"> ▪ 1 value, max. size ▪ 1 bargraph + 1 value ▪ 2 values ▪ 1 value large + 2 values ▪ 4 values 	1 value, max. size
Value 1 display	A local display is provided.	Select the measured value that is shown on the local display.	<ul style="list-style-type: none"> ▪ Volume flow ▪ Mass flow ▪ Corrected volume flow ▪ Flow velocity ▪ Totalizer 1 ▪ Totalizer 2 ▪ Totalizer 3 ▪ Current output 1 * ▪ Electronic temperature 	Volume flow
0% bargraph value 1	A local display is provided.	Enter 0% value for bar graph display.	Signed floating-point number	Country-specific: <ul style="list-style-type: none"> ▪ 0 l/h ▪ 0 gal/min (us)
100% bargraph value 1	A local display is provided.	Enter 100% value for bar graph display.	Signed floating-point number	Depends on country and nominal diameter
Decimal places 1	A measured value is specified in the Value 1 display parameter.	Select the number of decimal places for the display value.	<ul style="list-style-type: none"> ▪ x ▪ x.x ▪ x.xx ▪ x.xxx ▪ x.xxxx 	x.xx
Value 2 display	A local display is provided.	Select the measured value that is shown on the local display.	For the picklist, see the Value 1 display parameter (→  109)	None
Decimal places 2	A measured value is specified in the Value 2 display parameter.	Select the number of decimal places for the display value.	<ul style="list-style-type: none"> ▪ x ▪ x.x ▪ x.xx ▪ x.xxx ▪ x.xxxx 	x.xx
Value 3 display	A local display is provided.	Select the measured value that is shown on the local display.	For the picklist, see the Value 1 display parameter (→  109)	None
0% bargraph value 3	A selection was made in the Value 3 display parameter.	Enter 0% value for bar graph display.	Signed floating-point number	Country-specific: <ul style="list-style-type: none"> ▪ 0 l/h ▪ 0 gal/min (us)
100% bargraph value 3	A selection was made in the Value 3 display parameter.	Enter 100% value for bar graph display.	Signed floating-point number	0
Decimal places 3	A measured value is specified in the Value 3 display parameter.	Select the number of decimal places for the display value.	<ul style="list-style-type: none"> ▪ x ▪ x.x ▪ x.xx ▪ x.xxx ▪ x.xxxx 	x.xx
Value 4 display	A local display is provided.	Select the measured value that is shown on the local display.	For the picklist, see the Value 1 display parameter (→  109)	None

Parameter	Prerequisite	Description	Selection / User entry	Factory setting
Decimal places 4	A measured value is specified in the Value 4 display parameter.	Select the number of decimal places for the display value.	<ul style="list-style-type: none"> ■ x ■ x.x ■ x.xx ■ x.xxx ■ x.xxxx 	x.xx
Display language	A local display is provided.	Set display language.	<ul style="list-style-type: none"> ■ English ■ Deutsch * ■ Français * ■ Español * ■ Italiano * ■ Nederlands * ■ Portuguesa * ■ Polski * ■ русский язык (Russian) * ■ Svenska * ■ Türkçe * ■ 中文 (Chinese) * ■ 日本語 (Japanese) * ■ 한국어 (Korean) * ■ العربية (Arabic) * ■ Bahasa Indonesia * ■ ภาษาไทย (Thai) * ■ tiếng Việt (Vietnamese) * ■ čeština (Czech) * 	English (alternatively, the ordered language is preset in the device)
Display interval	A local display is provided.	Set time measured values are shown on display if display alternates between values.	1 to 10 s	5 s
Display damping	A local display is provided.	Set display reaction time to fluctuations in the measured value.	0.0 to 999.9 s	0.0 s
Header	A local display is provided.	Select header contents on local display.	<ul style="list-style-type: none"> ■ Device tag ■ Free text 	Device tag
Header text	In the Header parameter, the Free text option is selected.	Enter display header text.	Max. 12 characters such as letters, numbers or special characters (e.g. @, %, /)	-----
Separator	A local display is provided.	Select decimal separator for displaying numerical values.	<ul style="list-style-type: none"> ■ . (point) ■ , (comma) 	. (point)
Backlight	One of the following conditions is met: <ul style="list-style-type: none"> ■ Order code for "Display; operation", option F "4-line, illum.; touch control" ■ Order code for "Display; operation", option G "4-line, illum.; touch control +WLAN" ■ Order code for "Display; operation", option O "Separate 4-line display, illum.; 10m/30ft cable; touch control" 	Switch the local display backlight on and off.	<ul style="list-style-type: none"> ■ Disable ■ Enable 	Enable

* Visibility depends on order options or device settings





10.7.4 Performing electrode cleaning

The **Electrode cleaning circuit** submenu contains parameters that must be configured for the configuration of electrode cleaning.

 The submenu is only available if the device was ordered with electrode cleaning.

Navigation

"Setup" menu → Advanced setup → Electrode cleaning circuit

▶ Electrode cleaning circuit	
Electrode cleaning circuit	→  118
ECC duration	→  118
ECC recovery time	→  118
ECC cleaning cycle	→  118
ECC Polarity	→  118

Parameter overview with brief description

Parameter	Prerequisite	Description	Selection / User entry / User interface	Factory setting
Electrode cleaning circuit	For the following order code: "Application package", option EC "ECC electrode cleaning"	Enable the cyclic electrode cleaning circuit.	<ul style="list-style-type: none"> ▪ Off ▪ On 	Off
ECC duration	For the following order code: "Application package", option EC "ECC electrode cleaning"	Enter the duration of electrode cleaning in seconds.	0.01 to 30 s	2 s
ECC recovery time	For the following order code: "Application package", option EC "ECC electrode cleaning"	Define recovery time after electrode cleaning. During this time the current output values will be held at last valid value.	1 to 600 s	60 s
ECC cleaning cycle	For the following order code: "Application package", option EC "ECC electrode cleaning"	Enter the pause duration between electrode cleaning cycles.	0.5 to 168 h	0.5 h
ECC Polarity	For the following order code: "Application package", option EC "ECC electrode cleaning"	Select the polarity of the electrode cleaning circuit.	<ul style="list-style-type: none"> ▪ Positive ▪ Negative 	Depends on the electrode material: <ul style="list-style-type: none"> ▪ Platinum: Negative option ▪ Tantalum, Alloy C22, stainless steel: Positive option

10.7.5 WLAN configuration

The **WLAN Settings** submenu guides the user systematically through all the parameters that have to be set for the WLAN configuration.

Navigation

"Setup" menu → Advanced setup → WLAN settings

▶ **WLAN settings**

WLAN

WLAN mode

SSID name

Network security → ⓘ 119

Security identification

User name

WLAN password

WLAN IP address → ⓘ 119

WLAN MAC address

WLAN passphrase → ⓘ 120

Assign SSID name → ⓘ 120



SSID name → ⓘ 120

Connection state

Received signal strength

Parameter overview with brief description

Parameter	Prerequisite	Description	User entry / Selection	Factory setting
WLAN IP address	–	Enter IP address of the device WLAN interface.	4 octet: 0 to 255 (in the particular octet)	192.168.1.212
Network security	–	Select the security type of the WLAN network.	<ul style="list-style-type: none"> ■ Unsecured ■ WPA2-PSK ■ EAP-PEAP with MSCHAPv2 * ■ EAP-PEAP MSCHAPv2 no server authentic. * ■ EAP-TLS * 	WPA2-PSK

Parameter	Prerequisite	Description	User entry / Selection	Factory setting
WLAN passphrase	The WPA2-PSK option is selected in the Security type parameter.	Enter the network key (8 to 32 characters).  The network key supplied with the device should be changed during commissioning for security reasons.	8 to 32-digit character string comprising numbers, letters and special characters (without spaces)	Serial number of the measuring device (e.g. L100A802000)
Assign SSID name	–	Select which name will be used for SSID: device tag or user-defined name.	<ul style="list-style-type: none"> ▪ Device tag ▪ User-defined 	User-defined
SSID name	<ul style="list-style-type: none"> ▪ The User-defined option is selected in the Assign SSID name parameter. ▪ The WLAN access point option is selected in the WLAN mode parameter. 	Enter the user-defined SSID name (max. 32 characters).  The user-defined SSID name may only be assigned once. If the SSID name is assigned more than once, the devices can interfere with one another.	Max. 32-digit character string comprising numbers, letters and special characters	EH_device designation_last 7 digits of the serial number (e.g. EH_Promag_300_A 802000)
Apply changes	–	Use changed WLAN settings.	<ul style="list-style-type: none"> ▪ Cancel ▪ Ok 	Cancel

* Visibility depends on order options or device settings





10.7.6 Configuration management

After commissioning, you can save the current device configuration or restore the previous device configuration.

You can do so using the **Configuration management** parameter and the related options found in the **Configuration backup** submenu.

Navigation

"Setup" menu → Advanced setup → Configuration backup

► Configuration backup	
Operating time	→  121
Last backup	→  121
Configuration management	→  121
Backup state	→  121
Comparison result	→  121

Parameter overview with brief description *

Parameter	Description	User interface / Selection	Factory setting
Operating time	Indicates how long the device has been in operation.	Days (d), hours (h), minutes (m) and seconds (s)	–
Last backup	Shows when the last data backup was saved to HistoROM backup.	Days (d), hours (h), minutes (m) and seconds (s)	–
Configuration management	Select action for managing the device data in the HistoROM backup.	<ul style="list-style-type: none"> ■ Cancel ■ Execute backup ■ Restore * ■ Compare * ■ Clear backup data 	Cancel
Backup state	Shows the current status of data saving or restoring.	<ul style="list-style-type: none"> ■ None ■ Backup in progress ■ Restoring in progress ■ Delete in progress ■ Compare in progress ■ Restoring failed ■ Backup failed 	None
Comparison result	Comparison of current device data with HistoROM backup.	<ul style="list-style-type: none"> ■ Settings identical ■ Settings not identical ■ No backup available ■ Backup settings corrupt ■ Check not done ■ Dataset incompatible 	Check not done

* Visibility depends on order options or device settings

Function scope of the "Configuration management" parameter

Options	Description
Cancel	No action is executed and the user exits the parameter.
Execute backup	A backup copy of the current device configuration is saved from the HistoROM backup to the memory of the device. The backup copy includes the transmitter data of the device.
Restore	The last backup copy of the device configuration is restored from the device memory to the device's HistoROM backup. The backup copy includes the transmitter data of the device.
Compare	The device configuration saved in the device memory is compared with the current device configuration of the HistoROM backup.
Clear backup data	The backup copy of the device configuration is deleted from the memory of the device.

HistoROM backup

A HistoROM is a "non-volatile" device memory in the form of an EEPROM.



While this action is in progress, the configuration cannot be edited via the local display and a message on the processing status appears on the display.

10.7.7 Using parameters for device administration

The **Administration** submenu systematically guides the user through all the parameters that can be used for device administration purposes.

Navigation

"Setup" menu → Advanced setup → Administration

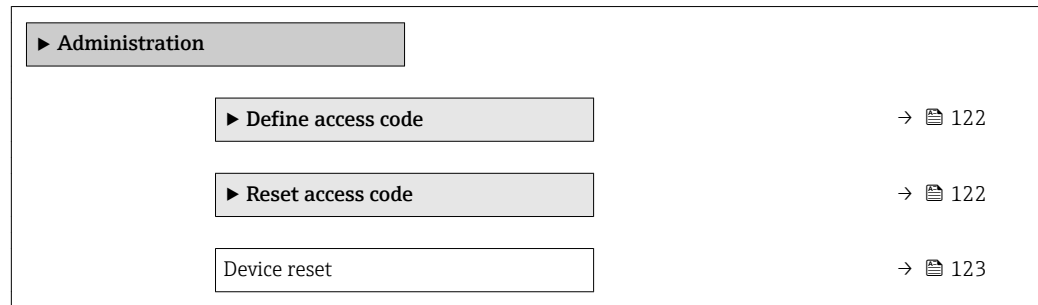
**Using the parameter to define the access code****Navigation**

"Setup" menu → Advanced setup → Administration → Define access code

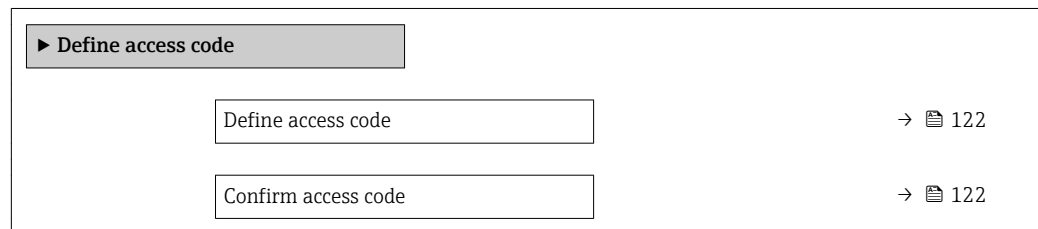
**Parameter overview with brief description**

Parameter	Description	User entry
Define access code	Restrict write-access to parameters to protect the configuration of the device against unintentional changes.	Max. 16-digit character string comprising numbers, letters and special characters
Confirm access code	Confirm the entered access code.	Max. 16-digit character string comprising numbers, letters and special characters

Using the parameter to reset the access code**Navigation**

"Setup" menu → Advanced setup → Administration → Reset access code

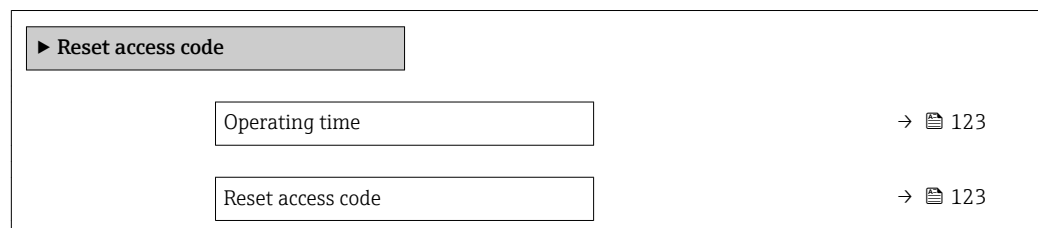

Parameter overview with brief description

Parameter	Description	User interface / User entry	Factory setting
Operating time	Indicates how long the device has been in operation.	Days (d), hours (h), minutes (m) and seconds (s)	-
Reset access code	Reset access code to factory settings.  For a reset code, contact your Endress+Hauser service organization. The reset code can only be entered via: <ul style="list-style-type: none"> ▪ Web browser ▪ DeviceCare, FieldCare (via service interface CDI-RJ45) ▪ Fieldbus 	Character string comprising numbers, letters and special characters	0x00

Using the parameter to reset the device

Navigation

"Setup" menu → Advanced setup → Administration

Parameter overview with brief description

Parameter	Description	Selection	Factory setting
Device reset	Reset the device configuration - either entirely or in part - to a defined state.	<ul style="list-style-type: none"> ▪ Cancel ▪ To delivery settings ▪ Restart device ▪ Restore S-DAT backup * 	Cancel

* Visibility depends on order options or device settings







10.8 Simulation











The **Simulation** submenu enables you to simulate, without a real flow situation, various process variables in the process and the device alarm mode and to verify downstream signal chains (switching valves or closed-control loops).

Navigation

"Diagnostics" menu → Simulation



▶ **Simulation**

- Assign simulation process variable →  124
- Process variable value →  124
- Status input simulation →  124
- Input signal level →  124
- Current input 1 to n simulation →  124
- Value current input 1 to n →  124

Current output 1 to n simulation	→  125
Value current output 1 to n	→  125
Frequency output simulation 1 to n	→  125
Frequency value 1 to n	→  125
Pulse output simulation 1 to n	→  125
Pulse value 1 to n	→  125
Switch output simulation 1 to n	→  125
Switch status 1 to n	→  125
Relay output 1 to n simulation	→  125
Switch status 1 to n	→  125
Device alarm simulation	→  125
Diagnostic event category	→  125
Diagnostic event simulation	→  126

Parameter overview with brief description

Parameter	Prerequisite	Description	Selection / User entry / User interface	Factory setting
Assign simulation process variable	–	Select a process variable for the simulation process that is activated.	<ul style="list-style-type: none"> ▪ Off ▪ Volume flow ▪ Mass flow ▪ Corrected volume flow ▪ Flow velocity[*] ▪ Conductivity 	Off
Process variable value	A process variable is selected in the Assign simulation process variable parameter (→  124).	Enter the simulation value for the selected process variable.	Depends on the process variable selected	0
Status input simulation	–	Switch simulation of the status input on and off.	<ul style="list-style-type: none"> ▪ Off ▪ On 	Off
Input signal level	In the Status input simulation parameter, the On option is selected.	Select the signal level for the simulation of the status input.	<ul style="list-style-type: none"> ▪ High ▪ Low 	High
Current input 1 to n simulation	–	Switch simulation of the current input on and off.	<ul style="list-style-type: none"> ▪ Off ▪ On 	Off
Value current input 1 to n	In the Current input 1 to n simulation parameter, the On option is selected.	Enter the current value for simulation.	0 to 22.5 mA	0 mA



Parameter	Prerequisite	Description	Selection / User entry / User interface	Factory setting
Current output 1 to n simulation	–	Switch the simulation of the current output on and off.	<ul style="list-style-type: none"> ■ Off ■ On 	Off
Value current output 1 to n	In the Current output 1 to n simulation parameter, the On option is selected.	Enter the current value for simulation.	3.59 to 22.5 mA	3.59 mA
Frequency output simulation 1 to n	In the Operating mode parameter, the Frequency option is selected.	Switch the simulation of the frequency output on and off.	<ul style="list-style-type: none"> ■ Off ■ On 	Off
Frequency value 1 to n	In the Frequency output simulation 1 to n parameter, the On option is selected.	Enter the frequency value for the simulation.	0.0 to 12 500.0 Hz	0.0 Hz
Pulse output simulation 1 to n	In the Operating mode parameter, the Pulse option is selected.	Set and switch off the pulse output simulation.  For Fixed value option: Pulse width parameter (→  102) defines the pulse width of the pulses output.	<ul style="list-style-type: none"> ■ Off ■ Fixed value ■ Down-counting value 	Off
Pulse value 1 to n	In the Pulse output simulation 1 to n parameter, the Down-counting value option is selected.	Enter the number of pulses for simulation.	0 to 65 535	0
Switch output simulation 1 to n	In the Operating mode parameter, the Switch option is selected.	Switch the simulation of the switch output on and off.	<ul style="list-style-type: none"> ■ Off ■ On 	Off
Switch status 1 to n	–	Select the status of the status output for the simulation.	<ul style="list-style-type: none"> ■ Open ■ Closed 	Open
Relay output 1 to n simulation	–	Switch simulation of the relay output on and off.	<ul style="list-style-type: none"> ■ Off ■ On 	Off
Switch status 1 to n	The On option is selected in the Switch output simulation 1 to n parameter parameter.	Select status of the relay output for the simulation.	<ul style="list-style-type: none"> ■ Open ■ Closed 	Open
Pulse output simulation	–	Set and switch off the pulse output simulation.  For Fixed value option: Pulse width parameter defines the pulse width of the pulses output.	<ul style="list-style-type: none"> ■ Off ■ Fixed value ■ Down-counting value 	Off
Pulse value	In the Pulse output simulation parameter, the Down-counting value option is selected.	Set and switch off the pulse output simulation.	0 to 65 535	0
Device alarm simulation	–	Switch the device alarm on and off.	<ul style="list-style-type: none"> ■ Off ■ On 	Off
Diagnostic event category	–	Select a diagnostic event category.	<ul style="list-style-type: none"> ■ Sensor ■ Electronics ■ Configuration ■ Process 	Process

Parameter	Prerequisite	Description	Selection / User entry / User interface	Factory setting
Diagnostic event simulation	–	Select a diagnostic event to simulate this event.	<ul style="list-style-type: none"> ▪ Off ▪ Diagnostic event picklist (depends on the category selected) 	Off
Logging interval	–	Define the logging interval tlog for data logging. This value defines the time interval between the individual data points in the memory.	1.0 to 3 600.0 s	–

* Visibility depends on order options or device settings

10.9 Protecting settings from unauthorized access

The following write protection options exist in order to protect the configuration of the measuring device from unintentional modification:



- Protect access to parameters via access code →  126
- Protect access to local operation via key locking →  66
- Protect access to measuring device via write protection switch →  127

10.9.1 Write protection via access code

The effects of the user-specific access code are as follows:



- Via local operation, the parameters for the measuring device configuration are write-protected and their values can no longer be changed.
- Device access is protected via the Web browser, as are the parameters for the measuring device configuration.
- Device access is protected via FieldCare or DeviceCare (via CDI-RJ45 service interface), as are the parameters for the measuring device configuration.

Defining the access code via local display

1. Navigate to the **Define access code** parameter (→  122).
2. Define a max. 16-digit character string comprising numbers, letters and special characters as the access code.
3. Enter the access code again in the **Confirm access code** parameter (→  122) to confirm the code.

↳ The -symbol appears in front of all write-protected parameters.

The device automatically locks the write-protected parameters again if a key is not pressed for 10 minutes in the navigation and editing view. The device locks the write-protected parameters automatically after 60 s if the user skips back to the operational display mode from the navigation and editing view.

-  ▪ If parameter write protection is activated via an access code, it can also only be deactivated via this access code →  65.
- The user role with which the user is currently logged on via the local display →  65 is indicated by the **Access status** parameter. Navigation path: Operation → Access status

Parameters which can always be modified via the local display

Certain parameters that do not affect the measurement are excepted from parameter write protection via the local display. Despite the user-specific access code, they can always be modified, even if the other parameters are locked.

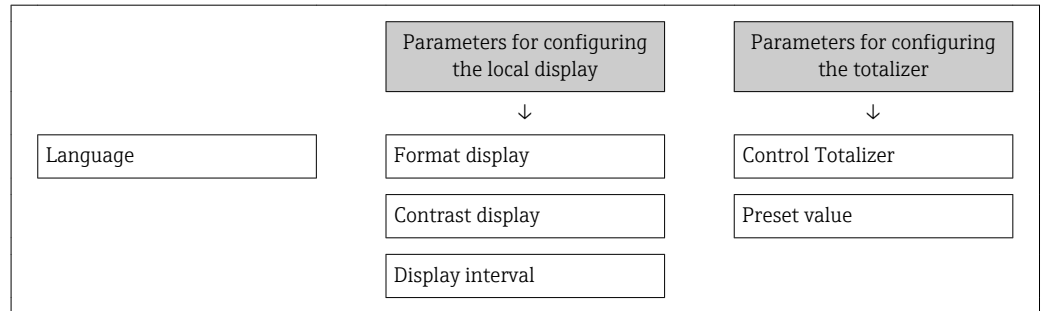

Defining the access code via the Web browser

1. Navigate to the **Define access code** parameter (→ 📄 122).
2. Define a max. 16-digit numeric code as an access code.
3. Enter the access code again in the **Confirm access code** parameter (→ 📄 122) to confirm the code.
 - ↳ The Web browser switches to the login page.

- i** If no action is performed for 10 minutes, the Web browser automatically returns to the login page.
- i**
 - If parameter write protection is activated via an access code, it can also only be deactivated via this access code → 📄 65.
 - The user role with which the user is currently logged on via Web browser is indicated by the **Access status** parameter. Navigation path: Operation → Access status

Resetting the access code

If you misplace the user-specific access code, it is possible to reset the code to the factory setting. A reset code must be entered for this purpose. The user-specific access code can then be defined again afterwards.

Via Web browser, FieldCare, DeviceCare (via CDI-RJ45 service interface), fieldbus

- i** For a reset code, contact your Endress+Hauser service organization.

1. Navigate to the **Reset access code** parameter (→ 📄 123).
2. Enter the reset code.
 - ↳ The access code has been reset to the factory setting **0000**. It can be redefined → 📄 126.

10.9.2 Write protection via write protection switch

Unlike parameter write protection via a user-specific access code, this allows write access to the entire operating menu - except for the **"Contrast display" parameter** - to be locked.

The parameter values are now read only and cannot be edited any more (exception **"Contrast display" parameter**):

- Via local display
- Via PROFIBUS PA protocol

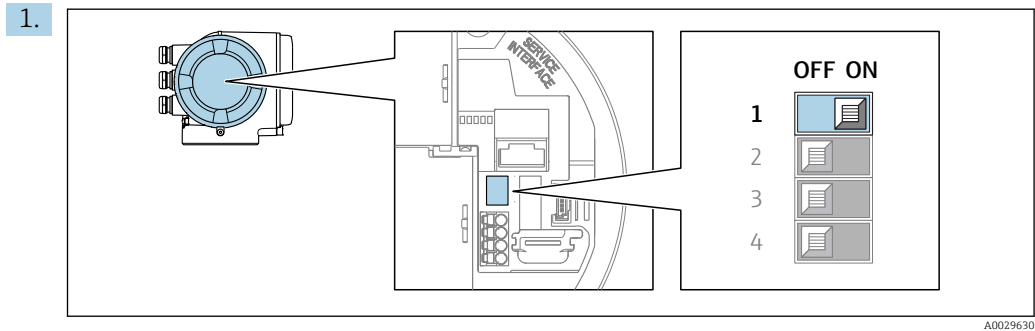

Setting the write protection (WP) switch on the main electronics module to the **ON** position enables hardware write protection.

- ↳ In the **Locking status** parameter the **Hardware locked** option is displayed → 129. In addition, on the local display the -symbol appears in front of the parameters in the header of the operational display and in the navigation view.

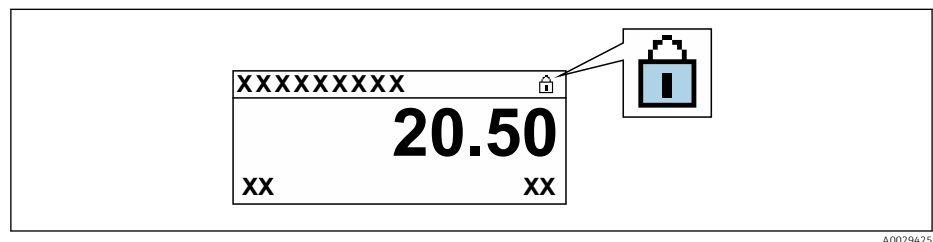

2. Setting the write protection (WP) switch on the main electronics module to the **OFF** position (factory setting) disables hardware write protection.

- ↳ No option is displayed in the **Locking status** parameter → 129. On the local display, the -symbol disappears from in front of the parameters in the header of the operational display and in the navigation view.



11 Operation

11.1 Reading the device locking status

Device active write protection: **Locking status** parameter



Operation → Locking status

Function scope of the "Locking status" parameter

Options	Description
None	The access status displayed in the Access status parameter applies →  65. Only appears on local display.
Hardware locked	The DIP switch for hardware locking is activated on the PCB board. This locks write access to the parameters (e.g. via local display or operating tool) →  127.
Temporarily locked	Write access to the parameters is temporarily locked on account of internal processes running in the device (e.g. data upload/download, reset etc.). Once the internal processing has been completed, the parameters can be changed once again.



11.2 Adjusting the operating language

 Detailed information:

- To configure the operating language →  90
- For information on the operating languages supported by the measuring device →  213

11.3 Configuring the display

Detailed information:





- On the basic settings for the local display →  108
- On the advanced settings for the local display →  115

11.4 Reading measured values

With the **Measured values** submenu, it is possible to read all the measured values.

Navigation

"Diagnostics" menu → Measured values

▶ Measured values	
▶ Process variables	→  130
▶ Totalizer 1 to n	→  130
▶ Input values	→  131
▶ Output values	→  132

11.4.1 "Process variables" submenu

The **Process variables** submenu contains all the parameters needed to display the current measured values for each process variable.

Navigation

"Diagnostics" menu → Measured values → Process variables

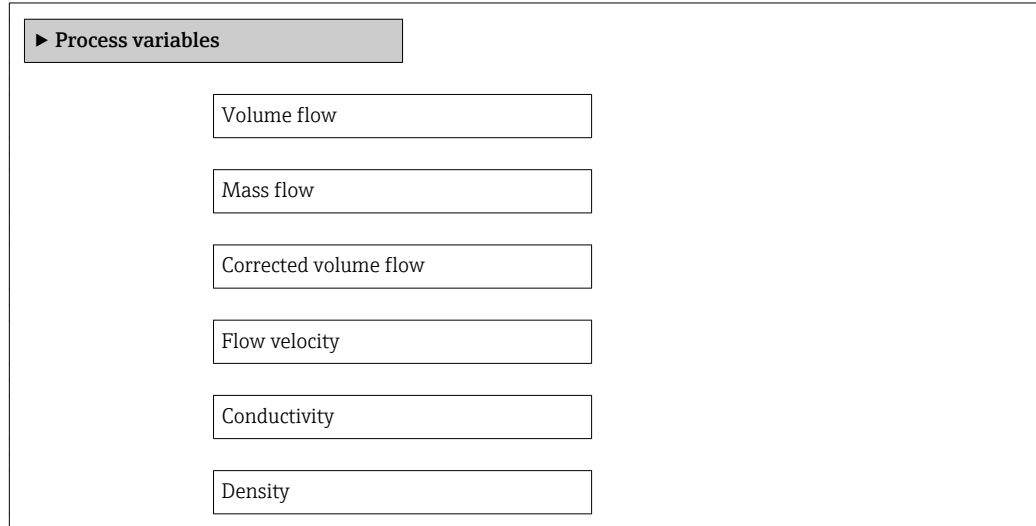

Parameter overview with brief description

Parameter	Description	User interface
Volume flow	Displays the volume flow that is currently measured. <i>Dependency</i> The unit is taken from the Volume flow unit parameter (→ 94).	Signed floating-point number
Mass flow	Displays the mass flow currently calculated. <i>Dependency</i> The unit is taken from the Mass flow unit parameter (→ 94).	Signed floating-point number
Corrected volume flow	Displays the corrected volume flow that is currently calculated. <i>Dependency</i> The unit is taken from the Corrected volume flow unit parameter.	Signed floating-point number
Flow velocity	Displays the flow velocity that is currently calculated.	Signed floating-point number
Conductivity	Displays the conductivity that is currently measured. <i>Dependency</i> The unit is taken from the Conductivity unit parameter.	Signed floating-point number
Density	Displays the current fixed density or density read in from an external device. <i>Dependency</i> The unit is taken from the Density unit parameter.	Signed floating-point number

11.4.2 Totalizer

The **Totalizer** submenu contains all the parameters needed to display the current measured values for every totalizer.

Navigation

"Diagnostics" menu → Measured values → Totalizer 1 to n

▶ **Totalizer 1 to n**

Assign process variable	→ ⓘ 131
Totalizer value 1 to n	→ ⓘ 131
Totalizer status 1 to n	→ ⓘ 131
Totalizer status (Hex) 1 to n	→ ⓘ 131

Parameter overview with brief description

Parameter	Prerequisite	Description	Selection / User entry / User interface	Factory setting
Assign process variable	–	Select process variable for totalizer.	<ul style="list-style-type: none"> ■ Volume flow ■ Mass flow ■ Corrected volume flow 	Volume flow
Totalizer value 1 to n	In the Assign process variable parameter one of the following options is selected: <ul style="list-style-type: none"> ■ Volume flow ■ Mass flow ■ Corrected volume flow ■ Total mass flow ■ Condensate mass flow ■ Energy flow ■ Heat flow difference 	Displays the current totalizer counter value.	Signed floating-point number	0 m ³
Totalizer status 1 to n	–	Displays the current totalizer status.	<ul style="list-style-type: none"> ■ Good ■ Uncertain ■ Bad 	–
Totalizer status (Hex) 1 to n	In Target mode parameter, the Auto option is selected.	Displays the current status value (hex) of the totalizer.	0 to 0xFF	–

11.4.3 "Input values" submenu

The **Input values** submenu guides you systematically to the individual input values.

Navigation

"Diagnostics" menu → Measured values → Input values

▶ **Input values**

▶ Current input 1 to n	→ ⓘ 132
▶ Status input 1 to n	→ ⓘ 132

Input values of current input

The **Current input 1 to n** submenu contains all the parameters needed to display the current measured values for every current input.

Navigation

"Diagnostics" menu → Measured values → Input values → Current input 1 to n

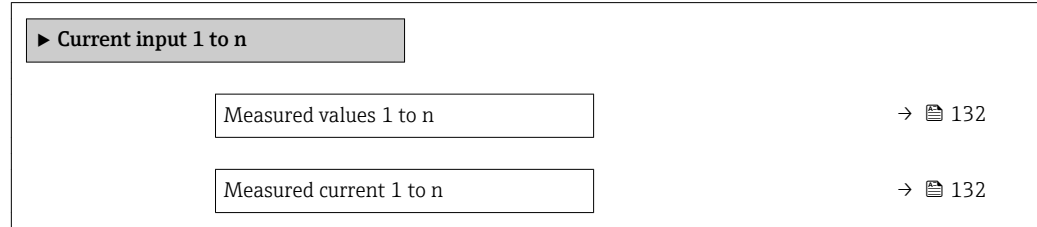

Parameter overview with brief description

Parameter	Description	User interface
Measured values 1 to n	Displays the current input value.	Signed floating-point number
Measured current 1 to n	Displays the current value of the current input.	0 to 22.5 mA

Input values of status input

The **Status input 1 to n** submenu contains all the parameters needed to display the current measured values for every status input.

Navigation

"Diagnostics" menu → Measured values → Input values → Status input 1 to n

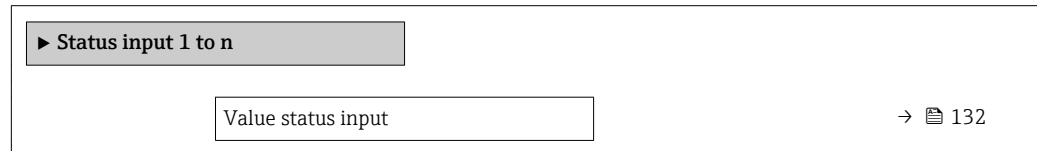

Parameter overview with brief description

Parameter	Description	User interface
Value status input	Shows the current input signal level.	<ul style="list-style-type: none"> ▪ High ▪ Low

11.4.4 Output values

The **Output values** submenu contains all the parameters needed to display the current measured values for every output.

Navigation

"Diagnostics" menu → Measured values → Output values

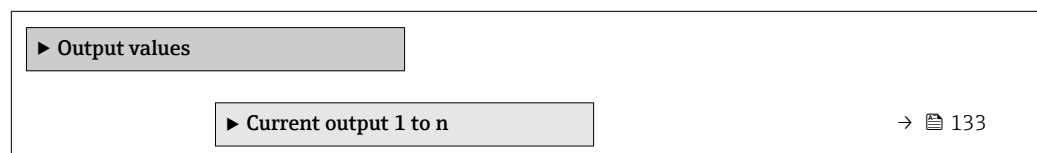

▶ Pulse/frequency/switch output 1 to n	→ 133
▶ Relay output 1 to n	→ 134

Output values of current output

The **Value current output** submenu contains all the parameters needed to display the current measured values for every current output.

Navigation

"Diagnostics" menu → Measured values → Output values → Value current output 1 to n

▶ Current output 1 to n	
Output current 1 to n	→ 133
Measured current 1 to n	→ 133

Parameter overview with brief description

Parameter	Description	User interface
Output current 1	Displays the current value currently calculated for the current output.	3.59 to 22.5 mA
Measured current	Displays the current value currently measured for the current output.	0 to 30 mA

Output values for pulse/frequency/switch output

The **Pulse/frequency/switch output 1 to n** submenu contains all the parameters needed to display the current measured values for every pulse/frequency/switch output.

Navigation

"Diagnostics" menu → Measured values → Output values → Pulse/frequency/switch output 1 to n

▶ Pulse/frequency/switch output 1 to n	
Output frequency 1 to n	→ 134
Pulse output 1 to n	→ 134
Switch status 1 to n	→ 134

Parameter overview with brief description

Parameter	Prerequisite	Description	User interface
Output frequency 1 to n	In the Operating mode parameter, the Frequency option is selected.	Displays the value currently measured for the frequency output.	0.0 to 12 500.0 Hz
Pulse output 1 to n	The Pulse option is selected in the Operating mode parameter parameter.	Displays the pulse frequency currently output.	Positive floating-point number
Switch status 1 to n	The Switch option is selected in the Operating mode parameter.	Displays the current switch output status.	<ul style="list-style-type: none"> ▪ Open ▪ Closed

Output values for relay output

The **Relay output 1 to n** submenu contains all the parameters needed to display the current measured values for every relay output.

Navigation

"Diagnostics" menu → Measured values → Output values → Relay output 1 to n

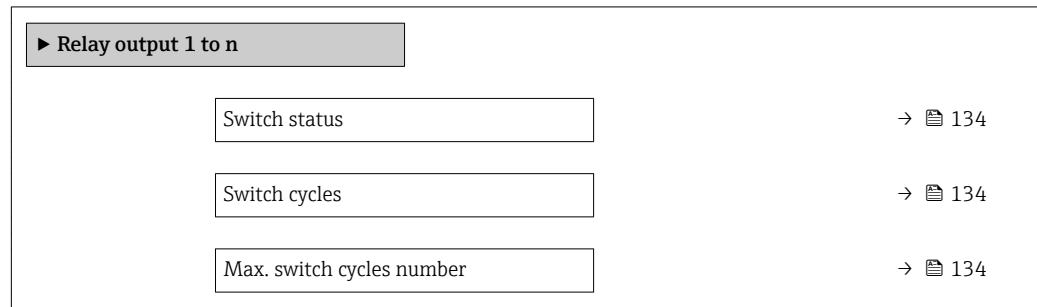

Parameter overview with brief description

Parameter	Description	User interface
Switch status	Shows the current relay switch status.	<ul style="list-style-type: none"> ▪ Open ▪ Closed
Switch cycles	Shows number of all performed switch cycles.	Positive integer
Max. switch cycles number	Shows the maximal number of guaranteed switch cycles.	Positive integer

11.5 Adapting the measuring device to the process conditions

The following are available for this purpose:

- Basic settings using the **Setup** menu (→ 📄 91)
- Advanced settings using the **Advanced setup** submenu (→ 📄 112)

11.6 Performing a totalizer reset

The totalizers are reset in the **Operation** submenu:
Control Totalizer

Function scope of the "Control Totalizer" parameter

Options	Description
Totalize	The totalizer is started.
Reset + hold	The totaling process is stopped and the totalizer is reset to 0.
Preset + hold	The totaling process is stopped and the totalizer is set to its defined start value from the Preset value 1 to n parameter.

Navigation

"Operation" menu → Totalizer handling

▶ **Totalizer handling**

Control Totalizer 1 to n	→ ⓘ 135
Preset value 1 to n	→ ⓘ 135
Reset all totalizers	→ ⓘ 135

Parameter overview with brief description

Parameter	Prerequisite	Description	Selection / User entry	Factory setting
Control Totalizer 1 to n	–	Control totalizer value.	<ul style="list-style-type: none"> ■ Totalize ■ Reset + hold ■ Preset + hold 	Totalize
Preset value 1 to n	In the Assign process variable parameter one of the following options is selected: <ul style="list-style-type: none"> ■ Volume flow ■ Mass flow ■ Corrected volume flow ■ Total mass flow ■ Condensate mass flow ■ Energy flow ■ Heat flow difference 	Specify start value for totalizer.	Signed floating-point number	0 m ³
Reset all totalizers	–	Reset all totalizers to 0 and start.	<ul style="list-style-type: none"> ■ Cancel ■ Reset + totalize 	Cancel

11.7 Showing data logging

The **Extended HistoROM** application package must be enabled in the device (order option) for the **Data logging** submenu to appear. This contains all the parameters for the measured value history.

-  Data logging is also available via:
- Plant Asset Management Tool FieldCare → ⓘ 75.
 - Web browser

Function range

- A total of 1000 measured values can be stored
- 4 logging channels
- Adjustable logging interval for data logging
- Displays the measured value trend for each logging channel in the form of a chart

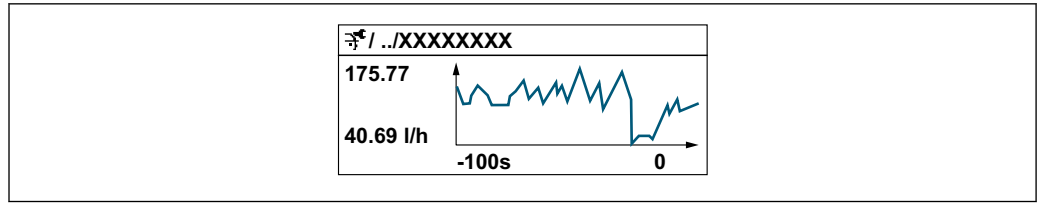

A0034352

- x-axis: depending on the number of channels selected displays 250 to 1000 measured values of a process variable.
- y-axis: displays the approximate measured value span and constantly adapts this to the ongoing measurement.

i If the length of the logging interval or the assignment of the process variables to the channels is changed, the content of the data logging is deleted.







Navigation

"Diagnostics" menu → Data logging

▶ Data logging

Assign channel 1	→ 137
Assign channel 2	→ 137
Assign channel 3	→ 137
Assign channel 4	→ 137
Logging interval	→ 137
Clear logging data	→ 137
Data logging	→ 137
Logging delay	→ 137
Data logging control	→ 137
Data logging status	→ 138
Entire logging duration	→ 138
▶ Display channel 1	
▶ Display channel 2	
▶ Display channel 3	
▶ Display channel 4	

Parameter overview with brief description

Parameter	Prerequisite	Description	Selection / User entry / User interface	Factory setting
Assign channel 1	The Extended HistoROM application package is available.	Assign process variable to logging channel.	<ul style="list-style-type: none"> ■ Off ■ Volume flow ■ Mass flow ■ Corrected volume flow ■ Flow velocity ■ Conductivity* ■ Electronic temperature ■ Current output 1* 	Off
Assign channel 2	The Extended HistoROM application package is available.  The software options currently enabled are displayed in the Software option overview parameter.	Assign process variable to logging channel.	Picklist, see Assign channel 1 parameter (→  137)	Off
Assign channel 3	The Extended HistoROM application package is available.  The software options currently enabled are displayed in the Software option overview parameter.	Assign process variable to logging channel.	Picklist, see Assign channel 1 parameter (→  137)	Off
Assign channel 4	The Extended HistoROM application package is available.  The software options currently enabled are displayed in the Software option overview parameter.	Assign process variable to logging channel.	Picklist, see Assign channel 1 parameter (→  137)	Off
Logging interval	The Extended HistoROM application package is available.	Define the logging interval for data logging. This value defines the time interval between the individual data points in the memory.	0.1 to 3 600.0 s	1.0 s
Clear logging data	The Extended HistoROM application package is available.	Clear the entire logging data.	<ul style="list-style-type: none"> ■ Cancel ■ Clear data 	Cancel
Data logging	–	Select the data logging method.	<ul style="list-style-type: none"> ■ Overwriting ■ Not overwriting 	Overwriting
Logging delay	In the Data logging parameter, the Not overwriting option is selected.	Enter the time delay for measured value logging.	0 to 999 h	0 h
Data logging control	In the Data logging parameter, the Not overwriting option is selected.	Start and stop measured value logging.	<ul style="list-style-type: none"> ■ None ■ Delete + start ■ Stop 	None

Parameter	Prerequisite	Description	Selection / User entry / User interface	Factory setting
Data logging status	In the Data logging parameter, the Not overwriting option is selected.	Displays the measured value logging status.	<ul style="list-style-type: none">▪ Done▪ Delay active▪ Active▪ Stopped	Done
Entire logging duration	In the Data logging parameter, the Not overwriting option is selected.	Displays the total logging duration.	Positive floating-point number	0 s

* Visibility depends on order options or device settings

12 Diagnostics and troubleshooting

12.1 General troubleshooting











For local display

Error	Possible causes	Solution
Local display dark and no output signals	Supply voltage does not match the value indicated on the nameplate.	Apply the correct supply voltage → 41.
Local display dark and no output signals	The polarity of the supply voltage is wrong.	Correct the polarity.
Local display dark and no output signals	No contact between connecting cables and terminals.	Check the connection of the cables and correct if necessary.
Local display dark and no output signals	Terminals are not plugged into the I/O electronics module correctly. Terminals are not plugged into the main electronics module correctly.	Check terminals.
Local display dark and no output signals	I/O electronics module is defective. Main electronics module is defective.	Order spare part → 182.
Local display is dark, but signal output is within the valid range	Display is set too bright or too dark.	<ul style="list-style-type: none"> ▪ Set the display brighter by simultaneously pressing $\square + \boxplus$. ▪ Set the display darker by simultaneously pressing $\square + \boxminus$.
Local display is dark, but signal output is within the valid range	The cable of the display module is not plugged in correctly.	Insert the plug correctly into the main electronics module and display module.
Local display is dark, but signal output is within the valid range	Display module is defective.	Order spare part → 182.
Backlighting of local display is red	Diagnostic event with "Alarm" diagnostic behavior has occurred.	Take remedial measures → 151
Text on local display appears in a foreign language and cannot be understood.	Incorrect operating language is configured.	<ol style="list-style-type: none"> 1. Press $\square + \boxplus$ for 2 s ("home position"). 2. Press \boxminus. 3. Set the desired language in the Display language parameter (→ 117).
Message on local display: "Communication Error" "Check Electronics"	Communication between the display module and the electronics is interrupted.	<ul style="list-style-type: none"> ▪ Check the cable and the connector between the main electronics module and display module. ▪ Order spare part → 182.

For output signals

Error	Possible causes	Solution
Signal output outside the valid range	Main electronics module is defective.	Order spare part → 182.
Device shows correct value on local display, but signal output is incorrect, though in the valid range.	Configuration error	Check and correct the parameter configuration.
Device measures incorrectly.	Configuration error or device is operated outside the application.	<ol style="list-style-type: none"> 1. Check and correct parameter configuration. 2. Observe limit values specified in the "Technical Data".

For access

Error	Possible causes	Solution
No write access to parameters	Hardware write protection enabled	Set the write protection switch on main electronics module to the OFF position →  127.
No write access to parameters	Current user role has limited access authorization	1. Check user role →  65. 2. Enter correct customer-specific access code →  65.
No connection via PROFIBUS PA	Device plug connected incorrectly	Check the pin assignment of the connector .
No connection via PROFIBUS PA	PROFIBUS PA cable incorrectly terminated	Check terminating resistor .
Not connecting to Web server	Web server disabled	Using the "FieldCare" or "DeviceCare" operating tool, check whether the Web server of the measuring device is enabled, and enable it if necessary →  72.
	Incorrect setting for the Ethernet interface of the computer	1. Check the properties of the Internet protocol (TCP/IP) →  68 →  68. 2. Check the network settings with the IT manager.
Not connecting to Web server	Incorrect IP address	Check the IP address: 192.168.1.212 →  68 →  68
Not connecting to Web server	Incorrect WLAN access data	<ul style="list-style-type: none"> ▪ Check WLAN network status. ▪ Log on to the device again using WLAN access data. ▪ Verify that WLAN is enabled on the measuring device and operating device →  68.
	WLAN communication disabled	–
Not connecting to Web server, FieldCare or DeviceCare	No WLAN network available	<ul style="list-style-type: none"> ▪ Check if WLAN reception is present: LED on display module is lit blue ▪ Check if WLAN connection is enabled: LED on display module flashes blue ▪ Switch on instrument function.
Network connection not present or unstable	WLAN network is weak.	<ul style="list-style-type: none"> ▪ Operating device is outside of reception range: Check network status on operating device. ▪ To improve network performance, use an external WLAN antenna.
	Parallel WLAN and Ethernet communication	<ul style="list-style-type: none"> ▪ Check network settings. ▪ Temporarily enable only the WLAN as an interface.
Web browser frozen and operation no longer possible	Data transfer active	Wait until data transfer or current action is finished.
	Connection lost	1. Check cable connection and power supply. 2. Refresh the Web browser and restart if necessary.
Content of Web browser incomplete or difficult to read	Not using optimum version of Web server.	1. Use the correct Web browser version →  67. 2. Clear the Web browser cache and restart the Web browser.
	Unsuitable view settings.	Change the font size/display ratio of the Web browser.

Error	Possible causes	Solution
No or incomplete display of contents in the Web browser	<ul style="list-style-type: none">▪ JavaScript not enabled▪ JavaScript cannot be enabled	1. Enable JavaScript. 2. Enter http://XXX.XXX.X.XXX/basic.html as the IP address.
Operation with FieldCare or DeviceCare via CDI-RJ45 service interface (port 8000)	Firewall of computer or network is preventing communication	Depending on the settings of the firewall used on the computer or in the network, the firewall must be adapted or disabled to allow FieldCare/DeviceCare access.
Flashing of firmware with FieldCare or DeviceCare via CDI-RJ45 service interface (via port 8000 or TFTP ports)	Firewall of computer or network is preventing communication	Depending on the settings of the firewall used on the computer or in the network, the firewall must be adapted or disabled to allow FieldCare/DeviceCare access.

12.2 Diagnostic information via light emitting diodes

12.2.1 Transmitter

Different LEDs in the transmitter provide information on the device status.

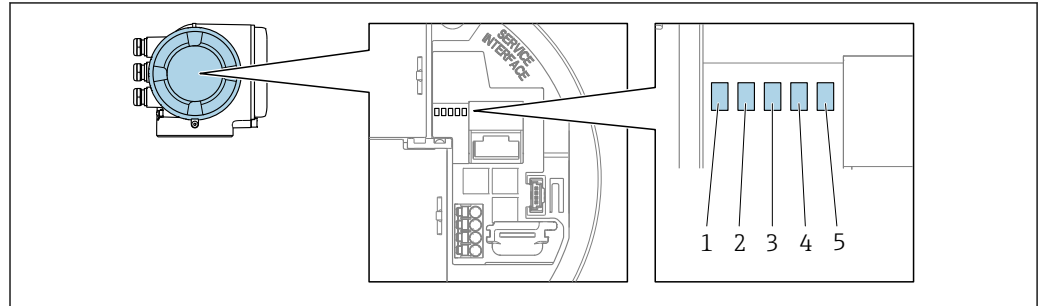

A0029629

- 1 Supply voltage
- 2 Device status
- 3 Not used
- 4 Communication
- 5 Service interface (CDI) active, Ethernet Link/Activity

LED	Color	Meaning
1 Supply voltage	Off	Supply voltage is off or too low.
	Green	Supply voltage is ok.
2 Device status (normal operation)	Off	Firmware error
	Green	Device status is ok.
	Flashing green	Device is not configured.
	Red	A diagnostic event with "Alarm" diagnostic behavior has occurred.
	Flashing red	A diagnostic event with "Warning" diagnostic behavior has occurred.
2 Device status (during start-up)	Flashes red slowly	If > 30 seconds: problem with the boot loader.
	Flashes red quickly	If > 30 seconds: compatibility problem when reading the firmware.
3 Not used	–	–
4 Communication	Off	Device does not receive any Profibus data.
	White	Device receives Profibus data.
5 Service interface (CDI), Ethernet Link/Activity	Off	Not connected or no connection established.
	Yellow	Connected and connection established.
	Flashing yellow	Service interface active.

12.3 Diagnostic information on local display

12.3.1 Diagnostic message

Faults detected by the self-monitoring system of the measuring device are displayed as a diagnostic message in alternation with the operational display.

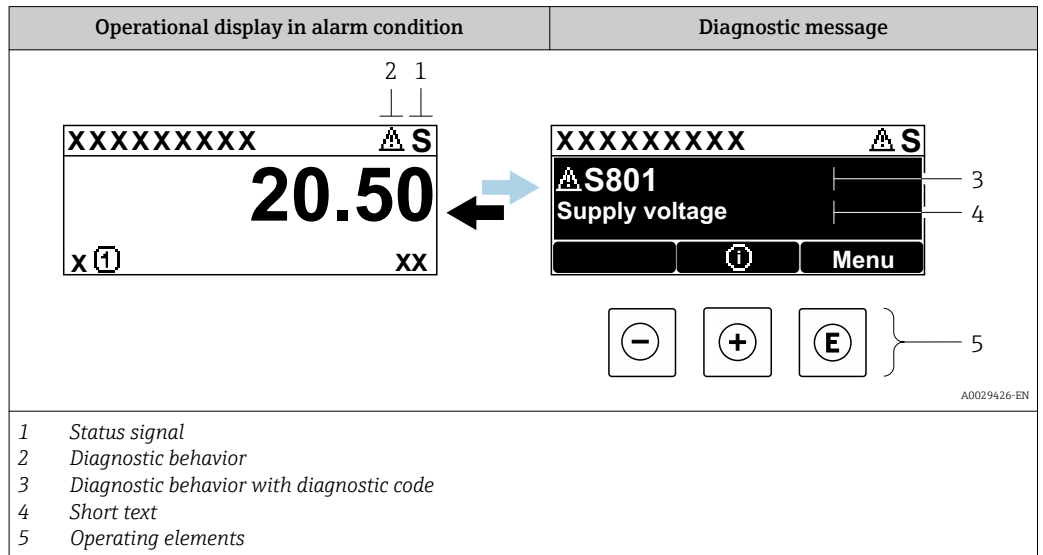

If two or more diagnostic events are pending simultaneously, only the message of the diagnostic event with the highest priority is shown.

- i** Other diagnostic events that have occurred can be displayed in the **Diagnostics** menu:
 - Via parameter → 174
 - Via submenus → 175



Status signals

The status signals provide information on the state and reliability of the device by categorizing the cause of the diagnostic information (diagnostic event).

- i** The status signals are categorized according to VDI/VDE 2650 and NAMUR Recommendation NE 107: F = Failure, C = Function Check, S = Out of Specification, M = Maintenance Required

Symbol	Meaning
F	Failure A device error has occurred. The measured value is no longer valid.
C	Function check The device is in service mode (e.g. during a simulation).
S	Out of specification The device is operated: Outside its technical specification limits (e.g. outside the process temperature range)
M	Maintenance required Maintenance is required. The measured value remains valid.

Diagnostic behavior



Symbol	Meaning
	Alarm <ul style="list-style-type: none"> ▪ Measurement is interrupted. ▪ Signal outputs and totalizers assume the defined alarm condition. ▪ A diagnostic message is generated.
	Warning Measurement is resumed. The signal outputs and totalizers are not affected. A diagnostic message is generated.

Diagnostic information

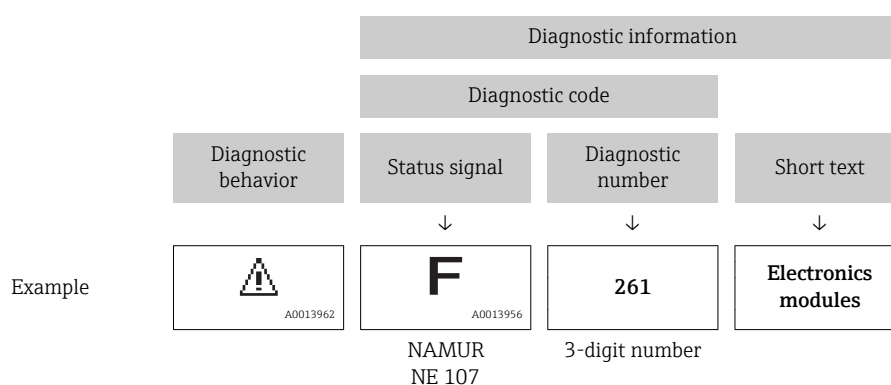
The fault can be identified using the diagnostic information. The short text helps you by providing information about the fault. In addition, the corresponding symbol for the diagnostic behavior is displayed in front of the diagnostic information on the local display.



Operating elements

Key	Meaning
	Plus key <i>In a menu, submenu</i> Opens the message about remedy information.
	Enter key <i>In a menu, submenu</i> Opens the operating menu.

12.3.2 Calling up remedial measures

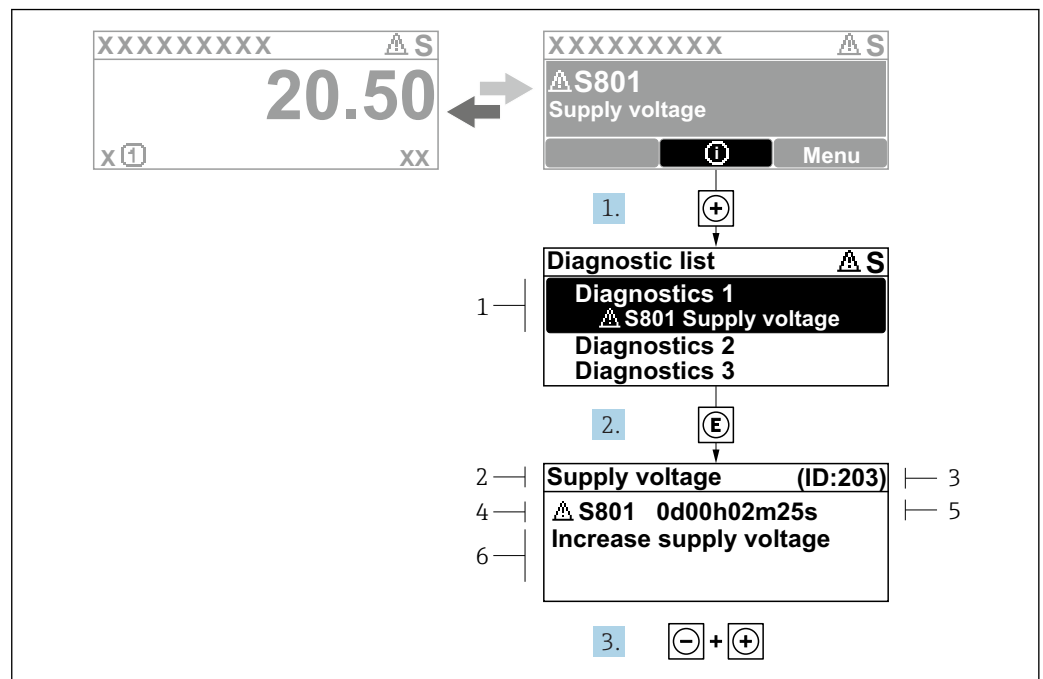

29 Message about remedial measures

- 1 Diagnostic information
- 2 Short text
- 3 Service ID
- 4 Diagnostic behavior with diagnostic code
- 5 Operation time of occurrence
- 6 Remedial measures

1. The user is in the diagnostic message.
Press \oplus ($\text{\textcircled{1}}$ symbol).
↳ The **Diagnostic list** submenu opens.
2. Select the desired diagnostic event with \oplus or \ominus and press $\text{\textcircled{E}}$.
↳ The message about the remedial measures opens.
3. Press $\ominus + \oplus$ simultaneously.
↳ The message about the remedial measures closes.

The user is in the **Diagnostics** menu at an entry for a diagnostics event, e.g. in the **Diagnostic list** submenu or **Previous diagnostics** parameter.

1. Press $\text{\textcircled{E}}$.
↳ The message for the remedial measures for the selected diagnostic event opens.
2. Press $\ominus + \oplus$ simultaneously.
↳ The message for the remedial measures closes.



12.4 Diagnostic information in the Web browser

12.4.1 Diagnostic options

Any faults detected by the measuring device are displayed in the Web browser on the home page once the user has logged on.





- 1 Status area with status signal
- 2 Diagnostic information
- 3 Remedy information with Service ID

 In addition, diagnostic events which have occurred can be shown in the **Diagnostics** menu:

- Via parameter →  174
- Via submenu →  175

Status signals

The status signals provide information on the state and reliability of the device by categorizing the cause of the diagnostic information (diagnostic event).

Symbol	Meaning
	Failure A device error has occurred. The measured value is no longer valid.
	Function check The device is in service mode (e.g. during a simulation).
	Out of specification The device is operated: Outside its technical specification limits (e.g. outside the process temperature range)
	Maintenance required Maintenance is required. The measured value is still valid.

 The status signals are categorized in accordance with VDI/VDE 2650 and NAMUR Recommendation NE 107.

12.4.2 Calling up remedy information

Remedy information is provided for every diagnostic event to ensure that problems can be rectified quickly. These measures are displayed in red along with the diagnostic event and the related diagnostic information.

12.5 Diagnostic information in FieldCare or DeviceCare

12.5.1 Diagnostic options

Any faults detected by the measuring device are displayed on the home page of the operating tool once the connection has been established.

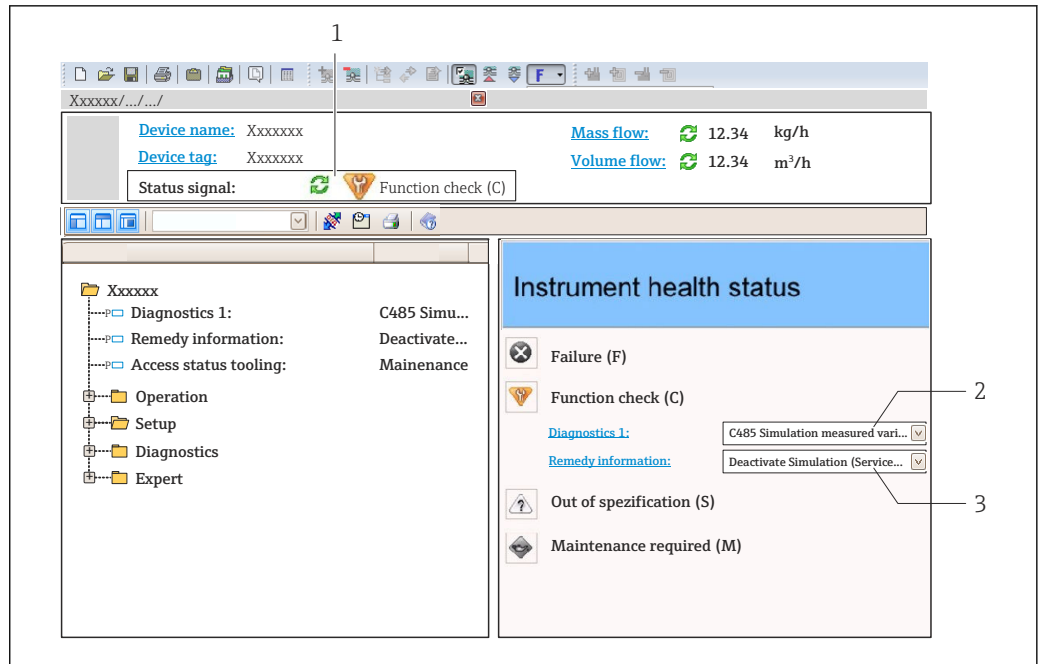

- 1 Status area with status signal → 143
- 2 Diagnostic information → 144
- 3 Remedy information with Service ID

i In addition, diagnostic events which have occurred can be shown in the **Diagnostics** menu:

- Via parameter → 174
- Via submenu → 175

Diagnostic information

The fault can be identified using the diagnostic information. The short text helps you by providing information about the fault. In addition, the corresponding symbol for the diagnostic behavior is displayed in front of the diagnostic information on the local display.

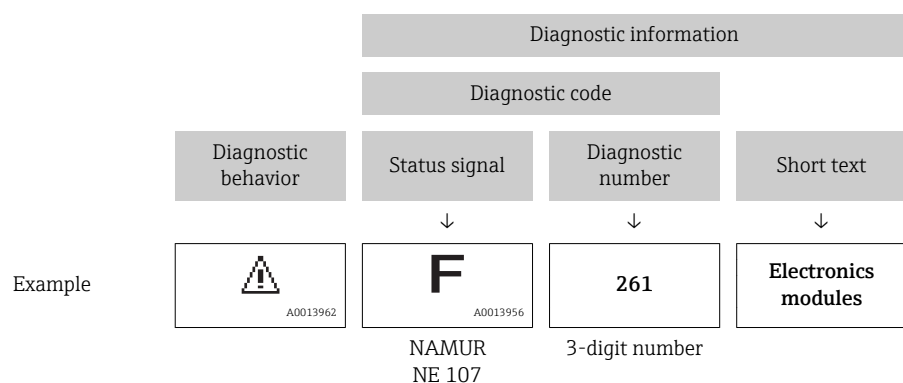

12.5.2 Calling up remedy information

Remedy information is provided for every diagnostic event to ensure that problems can be rectified quickly:

- On the home page
Remedy information is displayed in a separate field below the diagnostics information.
- In the **Diagnostics** menu
Remedy information can be called up in the working area of the user interface.

The user is in the **Diagnostics** menu.

1. Call up the desired parameter.
2. On the right in the working area, mouse over the parameter.
 - ↳ A tool tip with remedy information for the diagnostic event appears.

12.6 Adapting the diagnostic information

12.6.1 Adapting the diagnostic behavior

Each item of diagnostic information is assigned a specific diagnostic behavior at the factory. The user can change this assignment for specific diagnostic information in the **Diagnostic behavior** submenu.

i Diagnostic behavior in accordance with Specification PROFIBUS PA Profile 3.02, Condensed Status.

Expert → System → Diagnostic handling → Diagnostic behavior

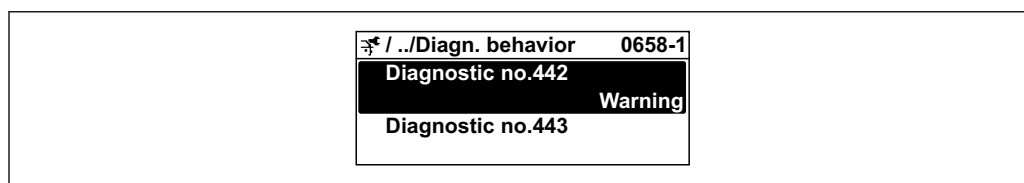

A0019179-EN

Available diagnostic behaviors

The following diagnostic behaviors can be assigned:

Diagnostic behavior	Description
Alarm	The device stops measurement. The totalizers assume the defined alarm condition. A diagnostic message is generated.
Warning	The device continues to measure. The measured value output via PROFIBUS and the totalizers are not affected. A diagnostic message is generated.
Logbook entry only	The device continues to measure. The diagnostic message is displayed only in the Event logbook submenu (Event list submenu) and not in alternation with the operational display.
Off	The diagnostic event is ignored, and no diagnostic message is generated or entered.

Displaying the measured value status

If the Analog Input, Digital Input and Totalizer function blocks are configured for cyclic data transmission, the device status is coded as per PROFIBUS PA Profile 3.02 Specification and transmitted along with the measured value to the PROFIBUS Master (Class 1) via the coding byte (byte 5). The coding byte is split into three segments: Quality, Quality Substatus and Limits.

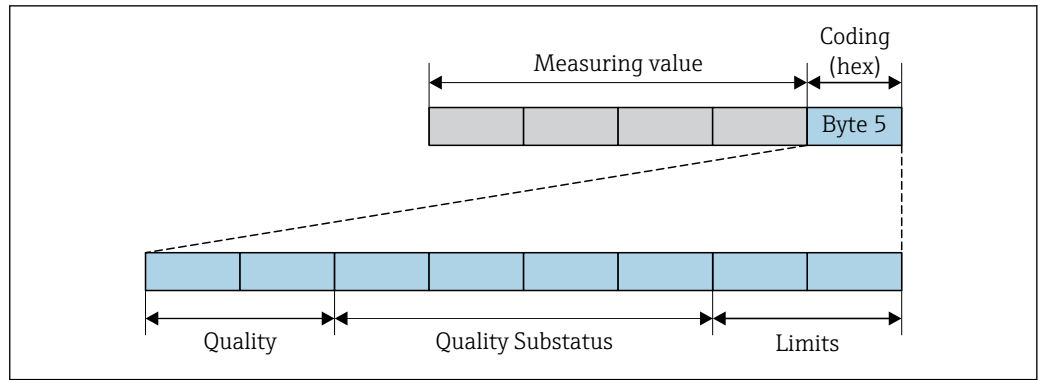

A0032228-EN

30 Structure of the coding byte

The content of the coding byte depends on the configured failsafe mode in the particular function block. Depending on which failsafe mode has been configured, status information in accordance with PROFIBUS PA Profile Specification 3.02 is transmitted to the PROFIBUS Master (Class 1) via the coding byte .

Determining the measured value status and device status via the diagnostic behavior

When the diagnostic behavior is assigned, this also changes the measured value status and device status for the diagnostic information. The measured value status and device status depend on the choice of diagnostic behavior and on the group in which the diagnostic information is located.

The diagnostic information is grouped as follows:

- Diagnostic information pertaining to the sensor: diagnostic number 000 to 199
→ 149
- Diagnostic information pertaining to the electronics: diagnostic number 200 to 399
→ 150
- Diagnostic information pertaining to the configuration: diagnostic number 400 to 599
→ 150
- Diagnostic information pertaining to the process: diagnostic number 800 to 999
→ 150

Depending on the group in which the diagnostic information is located, the following measured value status and device status are firmly assigned to the particular diagnostic behavior:

Diagnostic information pertaining to the sensor: diagnostic number 000 to 199

Diagnostic behavior (configurable)	Measured value status (fixed assignment)				Device diagnosis (fixed assignment)
	Quality	Quality Substatus	Coding (hex)	Category (NE107)	
Alarm	BAD	Maintenance alarm	0x24 to 0x27	F (Failure)	Maintenance alarm
Warning	GOOD	Maintenance demanded	0xA8 to 0xAB	M (Maintenance)	Maintenance demanded
Logbook entry only	GOOD	ok	0x80 to 0x8E	-	-
Off					

Diagnostic information pertaining to the electronics: diagnostic number 200 to 399

Diagnostic number 200 to 301, 303 to 399

Diagnostic behavior (configurable)	Measured value status (fixed assignment)				Device diagnosis (fixed assignment)
	Quality	Quality Substatus	Coding (hex)	Category (NE107)	
Alarm	BAD	Maintenance alarm	0x24 to 0x27	F (Failure)	Maintenance alarm
Warning					
Logbook entry only	GOOD	ok	0x80 to 0x8E	-	-
Off					

Diagnostic information 302

Diagnostic behavior (configurable)	Measured value status (fixed assignment)				Device diagnosis (fixed assignment)
	Quality	Quality Substatus	Coding (hex)	Category (NE107)	
Alarm	BAD	Function check, local override	0x24 to 0x27	C	Function check
Warning	GOOD	Function check	0xBC to 0xBF	-	-

Diagnostic information 302 (device verification active) is output during internal or external Heartbeat verification.

- Signal status: Function check
- Choice of diagnostic behavior: alarm or warning (factory setting)

When Heartbeat verification starts, data logging is interrupted, the last valid measured value is output and the totalizers are stopped.

Diagnostic information pertaining to the configuration: diagnostic number 400 to 599

Diagnostic behavior (configurable)	Measured value status (fixed assignment)				Device diagnosis (fixed assignment)
	Quality	Quality Substatus	Coding (hex)	Category (NE107)	
Alarm	BAD	Process related	0x28 to 0x2B	F (Failure)	Invalid process condition
Warning	UNCERTAIN	Process related	0x78 to 0x7B	S (Out of specification)	Invalid process condition
Logbook entry only	GOOD	ok	0x80 to 0x8E	-	-
Off					



Diagnostic information pertaining to the process: diagnostic number 800 to 999

Diagnostic behavior (configurable)	Measured value status (fixed assignment)				Device diagnosis (fixed assignment)
	Quality	Quality Substatus	Coding (hex)	Category (NE107)	
Alarm	BAD	Process related	0x28 to 0x2B	F (Failure)	Invalid process condition
Warning	UNCERTAIN	Process related	0x78 to 0x7B	S (Out of specification)	Invalid process condition

Diagnostic behavior (configurable)	Measured value status (fixed assignment)				Device diagnosis (fixed assignment)
	Quality	Quality Substatus	Coding (hex)	Category (NE107)	
Logbook entry only	GOOD	ok	0x80 to 0x8E	-	-
Off					

12.7 Overview of diagnostic information

 The amount of diagnostic information and the number of measured variables affected increase if the measuring device has one or more application packages.

 In the case of some items of diagnostic information, the diagnostic behavior can be changed. Change the diagnostic information →  148

12.7.1 Diagnostic of sensor

Diagnostic information		Remedy instructions	Influenced measured variables	
No.	Short text			
043	Sensor short circuit	1. Check sensor cable and sensor 2. Execute Heartbeat Verification 3. Replace sensor cable or sensor	<ul style="list-style-type: none"> ■ Conductivity ■ Corrected conductivity ■ Density ■ Electronic temperature ■ Empty pipe detection ■ Flow velocity ■ Low flow cut off ■ Mass flow ■ Reference density ■ Corrected volume flow ■ Temperature ■ Status ■ Volume flow 	
	Measured variable status [from the factory] ¹⁾			
	Quality			Uncertain
	Quality substatus			Maintenance demanded
	Coding (hex)			0x68 to 0x6B
	Status signal			S
	Diagnostic behavior			Warning

1) Diagnostic behavior can be changed. This causes the overall status of the measured variable to change.

Diagnostic information		Remedy instructions	Influenced measured variables	
No.	Short text			
082	Data storage	1. Check module connections 2. Contact service	<ul style="list-style-type: none"> ■ Conductivity ■ Corrected conductivity ■ Measured values 1 ■ Measured values 2 ■ Measured values 3 ■ Density ■ Electronic temperature ■ Empty pipe detection ■ Flow velocity ■ Low flow cut off ■ Mass flow ■ Reference density ■ Corrected volume flow ■ Temperature ■ Status ■ Volume flow 	
	Measured variable status			
	Quality			Bad
	Quality substatus			Maintenance alarm
	Coding (hex)			0x24 to 0x27
	Status signal			F
	Diagnostic behavior			Alarm

Diagnostic information		Remedy instructions	Influenced measured variables	
No.	Short text			
083	Memory content	1. Restart device 2. Restore HistoROM S-DAT backup ('Device reset' parameter) 3. Replace HistoROM S-DAT	<ul style="list-style-type: none"> ■ Conductivity ■ Corrected conductivity ■ Measured values 1 ■ Measured values 2 ■ Measured values 3 ■ Density ■ Electronic temperature ■ Empty pipe detection ■ Flow velocity ■ Low flow cut off ■ Mass flow ■ Reference density ■ Corrected volume flow ■ Temperature ■ Status ■ Volume flow 	
	Measured variable status			
	Quality			Bad
	Quality substatus			Maintenance alarm
	Coding (hex)			0x24 to 0x27
	Status signal			F
	Diagnostic behavior			Alarm

Diagnostic information		Remedy instructions	Influenced measured variables	
No.	Short text			
169	Conductivity measurement failed	1. Check grounding conditions 2. Deactivate conductivity measurement	<ul style="list-style-type: none"> ■ Conductivity ■ Corrected conductivity ■ Electronic temperature ■ Empty pipe detection ■ Flow velocity ■ Low flow cut off ■ Mass flow ■ Corrected volume flow ■ Temperature ■ Status ■ Volume flow 	
	Measured variable status			
	Quality			Bad
	Quality substatus			Maintenance alarm
	Coding (hex)			0x24 to 0x27
	Status signal			M
	Diagnostic behavior			Warning

Diagnostic information		Remedy instructions	Influenced measured variables	
No.	Short text			
170	Coil resistance	Check ambient and process temperature	<ul style="list-style-type: none"> ■ Conductivity ■ Corrected conductivity ■ Density ■ Electronic temperature ■ Empty pipe detection ■ Flow velocity ■ Low flow cut off ■ Mass flow ■ Reference density ■ Corrected volume flow ■ Temperature ■ Status ■ Volume flow 	
	Measured variable status			
	Quality			Bad
	Quality substatus			Maintenance alarm
	Coding (hex)			0x24 to 0x27
	Status signal			F
	Diagnostic behavior			Alarm

Diagnostic information		Remedy instructions	Influenced measured variables	
No.	Short text			
180	Temperature sensor defective	1. Check sensor connections 2. Replace sensor cable or sensor 3. Turn off temperature measurement	<ul style="list-style-type: none"> ■ Conductivity ■ Corrected conductivity ■ Density ■ Electronic temperature ■ Empty pipe detection ■ Flow velocity ■ Low flow cut off ■ Mass flow ■ Reference density ■ Corrected volume flow ■ Temperature ■ Status ■ Volume flow 	
	Measured variable status			
	Quality			Bad
	Quality substatus			Maintenance alarm
	Coding (hex)			0x24 to 0x27
	Status signal			F
Diagnostic behavior	Warning			

Diagnostic information		Remedy instructions	Influenced measured variables	
No.	Short text			
181	Sensor connection	1. Check sensor cable and sensor 2. Execute Heartbeat Verification 3. Replace sensor cable or sensor	<ul style="list-style-type: none"> ■ Conductivity ■ Corrected conductivity ■ Density ■ Electronic temperature ■ Empty pipe detection ■ Flow velocity ■ Low flow cut off ■ Mass flow ■ Reference density ■ Corrected volume flow ■ Temperature ■ Status ■ Volume flow 	
	Measured variable status			
	Quality			Bad
	Quality substatus			Maintenance alarm
	Coding (hex)			0x24 to 0x27
	Status signal			F
Diagnostic behavior	Alarm			

12.7.2 Diagnostic of electronic

Diagnostic information		Remedy instructions	Influenced measured variables	
No.	Short text			
201	Device failure	1. Restart device 2. Contact service	<ul style="list-style-type: none"> ■ Conductivity ■ Corrected conductivity ■ Measured values 1 ■ Measured values 2 ■ Measured values 3 ■ Density ■ Electronic temperature ■ Empty pipe detection ■ Flow velocity ■ Low flow cut off ■ Mass flow ■ Reference density ■ Corrected volume flow ■ Temperature ■ Status ■ Volume flow 	
	Measured variable status			
	Quality			Bad
	Quality substatus			Maintenance alarm
	Coding (hex)			0x24 to 0x27
	Status signal			F
Diagnostic behavior	Alarm			

Diagnostic information		Remedy instructions	Influenced measured variables	
No.	Short text			
242	Software incompatible	<ol style="list-style-type: none"> 1. Check software 2. Flash or change main electronics module 	<ul style="list-style-type: none"> ▪ Conductivity ▪ Corrected conductivity ▪ Measured values 1 ▪ Measured values 2 ▪ Measured values 3 ▪ Density ▪ Electronic temperature ▪ Empty pipe detection ▪ Flow velocity ▪ Low flow cut off ▪ Mass flow ▪ Reference density ▪ Corrected volume flow ▪ Temperature ▪ Status ▪ Volume flow 	
	Measured variable status			
	Quality			Bad
	Quality substatus			Maintenance alarm
	Coding (hex)			0x24 to 0x27
	Status signal			F
	Diagnostic behavior			Alarm

Diagnostic information		Remedy instructions	Influenced measured variables	
No.	Short text			
252	Modules incompatible	<ol style="list-style-type: none"> 1. Check electronic modules 2. Check if correct modules are available (e.g. NEx, Ex) 3. Replace electronic modules 	<ul style="list-style-type: none"> ▪ Conductivity ▪ Corrected conductivity ▪ Measured values 1 ▪ Measured values 2 ▪ Measured values 3 ▪ Density ▪ Electronic temperature ▪ Empty pipe detection ▪ Flow velocity ▪ Low flow cut off ▪ Mass flow ▪ Reference density ▪ Corrected volume flow ▪ Temperature ▪ Volume flow 	
	Measured variable status			
	Quality			Bad
	Quality substatus			Maintenance alarm
	Coding (hex)			0x24 to 0x27
	Status signal			F
	Diagnostic behavior			Alarm

Diagnostic information		Remedy instructions	Influenced measured variables	
No.	Short text			
252	Modules incompatible	<ol style="list-style-type: none"> 1. Check if correct electronic modul is plugged 2. Replace electronic module 	<ul style="list-style-type: none"> ▪ Conductivity ▪ Corrected conductivity ▪ Measured values 1 ▪ Measured values 2 ▪ Measured values 3 ▪ Density ▪ Electronic temperature ▪ Empty pipe detection ▪ Flow velocity ▪ Low flow cut off ▪ Mass flow ▪ Reference density ▪ Corrected volume flow ▪ Temperature ▪ Status ▪ Volume flow 	
	Measured variable status			
	Quality			Bad
	Quality substatus			Maintenance alarm
	Coding (hex)			0x24 to 0x27
	Status signal			F
	Diagnostic behavior			Alarm

Diagnostic information		Remedy instructions	Influenced measured variables
No.	Short text		
262	Sensor electronic connection faulty		<ul style="list-style-type: none"> ■ Conductivity ■ Corrected conductivity ■ Measured values 1 ■ Measured values 2 ■ Measured values 3 ■ Density ■ Electronic temperature ■ Empty pipe detection ■ Flow velocity ■ Low flow cut off ■ Mass flow ■ Reference density ■ Corrected volume flow ■ Temperature ■ Status ■ Volume flow
	Measured variable status		
	Quality	Bad	
	Quality substatus	Maintenance alarm	
	Coding (hex)	0x24 to 0x27	
	Status signal	F	
Diagnostic behavior	Alarm		
		<ol style="list-style-type: none"> 1. Check or replace connection cable between sensor electronic module (ISEM) and main electronics 2. Check or replace ISEM or main electronics 	

Diagnostic information		Remedy instructions	Influenced measured variables
No.	Short text		
270	Main electronic failure		<ul style="list-style-type: none"> ■ Conductivity ■ Corrected conductivity ■ Measured values 1 ■ Measured values 2 ■ Measured values 3 ■ Density ■ Electronic temperature ■ Empty pipe detection ■ Flow velocity ■ Low flow cut off ■ Mass flow ■ Reference density ■ Corrected volume flow ■ Temperature ■ Status ■ Volume flow
	Measured variable status		
	Quality	Bad	
	Quality substatus	Maintenance alarm	
	Coding (hex)	0x24 to 0x27	
	Status signal	F	
Diagnostic behavior	Alarm		
		Change main electronic module	

Diagnostic information		Remedy instructions	Influenced measured variables
No.	Short text		
271	Main electronic failure		<ul style="list-style-type: none"> ■ Conductivity ■ Corrected conductivity ■ Measured values 1 ■ Measured values 2 ■ Measured values 3 ■ Density ■ Electronic temperature ■ Empty pipe detection ■ Flow velocity ■ Low flow cut off ■ Mass flow ■ Reference density ■ Corrected volume flow ■ Temperature ■ Status ■ Volume flow
	Measured variable status		
	Quality	Bad	
	Quality substatus	Maintenance alarm	
	Coding (hex)	0x24 to 0x27	
	Status signal	F	
Diagnostic behavior	Alarm		
		<ol style="list-style-type: none"> 1. Restart device 2. Change main electronic module 	

Diagnostic information		Remedy instructions	Influenced measured variables	
No.	Short text			
272	Main electronic failure	1. Restart device 2. Contact service	<ul style="list-style-type: none"> ▪ Conductivity ▪ Corrected conductivity ▪ Measured values 1 ▪ Measured values 2 ▪ Measured values 3 ▪ Density ▪ Electronic temperature ▪ Empty pipe detection ▪ Flow velocity ▪ Low flow cut off ▪ Mass flow ▪ Reference density ▪ Corrected volume flow ▪ Temperature ▪ Status ▪ Volume flow 	
	Measured variable status			
	Quality			Bad
	Quality substatus			Maintenance alarm
	Coding (hex)			0x24 to 0x27
	Status signal			F
	Diagnostic behavior			Alarm

Diagnostic information		Remedy instructions	Influenced measured variables	
No.	Short text			
273	Main electronic failure	Change electronic	<ul style="list-style-type: none"> ▪ Conductivity ▪ Corrected conductivity ▪ Measured values 1 ▪ Measured values 2 ▪ Measured values 3 ▪ Density ▪ Electronic temperature ▪ Empty pipe detection ▪ Flow velocity ▪ Low flow cut off ▪ Mass flow ▪ Reference density ▪ Corrected volume flow ▪ Temperature ▪ Status ▪ Volume flow 	
	Measured variable status			
	Quality			Bad
	Quality substatus			Maintenance alarm
	Coding (hex)			0x24 to 0x27
	Status signal			F
	Diagnostic behavior			Alarm

Diagnostic information		Remedy instructions	Influenced measured variables	
No.	Short text			
275	I/O module 1 to n defective	Change I/O module	<ul style="list-style-type: none"> ▪ Conductivity ▪ Corrected conductivity ▪ Measured values 1 ▪ Measured values 2 ▪ Measured values 3 ▪ Density ▪ Electronic temperature ▪ Empty pipe detection ▪ Flow velocity ▪ Low flow cut off ▪ Mass flow ▪ Reference density ▪ Corrected volume flow ▪ Temperature ▪ Status ▪ Volume flow 	
	Measured variable status			
	Quality			Bad
	Quality substatus			Maintenance alarm
	Coding (hex)			0x24 to 0x27
	Status signal			F
	Diagnostic behavior			Alarm

Diagnostic information		Remedy instructions	Influenced measured variables	
No.	Short text			
276	I/O module 1 to n faulty	1. Restart device 2. Change I/O module	<ul style="list-style-type: none"> ■ Conductivity ■ Corrected conductivity ■ Measured values 1 ■ Measured values 2 ■ Measured values 3 ■ Density ■ Electronic temperature ■ Empty pipe detection ■ Flow velocity ■ Low flow cut off ■ Mass flow ■ Reference density ■ Corrected volume flow ■ Temperature ■ Status ■ Volume flow 	
	Measured variable status			
	Quality			Bad
	Quality substatus			Maintenance alarm
	Coding (hex)			0x24 to 0x27
	Status signal			F
	Diagnostic behavior			Alarm

Diagnostic information		Remedy instructions	Influenced measured variables	
No.	Short text			
283	Memory content	1. Reset device 2. Contact service	<ul style="list-style-type: none"> ■ Conductivity ■ Corrected conductivity ■ Measured values 1 ■ Measured values 2 ■ Measured values 3 ■ Density ■ Electronic temperature ■ Empty pipe detection ■ Flow velocity ■ Low flow cut off ■ Mass flow ■ Reference density ■ Corrected volume flow ■ Temperature ■ Status ■ Volume flow 	
	Measured variable status			
	Quality			Bad
	Quality substatus			Maintenance alarm
	Coding (hex)			0x24 to 0x27
	Status signal			F
	Diagnostic behavior			Alarm

Diagnostic information		Remedy instructions	Influenced measured variables	
No.	Short text			
302	Device verification active	Device verification active, please wait.	<ul style="list-style-type: none"> ■ Conductivity ■ Corrected conductivity ■ Measured values 1 ■ Measured values 2 ■ Measured values 3 ■ Density ■ Electronic temperature ■ Empty pipe detection ■ Flow velocity ■ Low flow cut off ■ Mass flow ■ Reference density ■ Corrected volume flow ■ Temperature ■ Status ■ Volume flow 	
	Measured variable status [from the factory] ¹⁾			
	Quality			Good
	Quality substatus			Function check
	Coding (hex)			0xBC to 0xBF
	Status signal			C
	Diagnostic behavior			Warning

1) Diagnostic behavior can be changed. This causes the overall status of the measured variable to change.

Diagnostic information		Remedy instructions	Influenced measured variables	
No.	Short text			
303	I/O 1 to n configuration changed	1. Apply I/O module configuration (parameter 'Apply I/O configuration') 2. Afterwards reload device description and check wiring	-	
	Measured variable status			
	Quality			Bad
	Quality substatus			Maintenance alarm
	Coding (hex)			0x24 to 0x27
	Status signal			M
	Diagnostic behavior			Warning

Diagnostic information		Remedy instructions	Influenced measured variables	
No.	Short text			
311	Electronic failure	1. Do not reset device 2. Contact service	<ul style="list-style-type: none"> ▪ Conductivity ▪ Corrected conductivity ▪ Measured values 1 ▪ Measured values 2 ▪ Measured values 3 ▪ Density ▪ Electronic temperature ▪ Empty pipe detection ▪ Flow velocity ▪ Low flow cut off ▪ Mass flow ▪ Reference density ▪ Corrected volume flow ▪ Temperature ▪ Status ▪ Volume flow 	
	Measured variable status			
	Quality			Bad
	Quality substatus			Maintenance alarm
	Coding (hex)			0x24 to 0x27
	Status signal			M
	Diagnostic behavior			Warning

Diagnostic information		Remedy instructions	Influenced measured variables	
No.	Short text			
332	Writing in HistoROM backup failed	Replace user interface board Ex d/XP: replace transmitter	<ul style="list-style-type: none"> ▪ Conductivity ▪ Corrected conductivity ▪ Measured values 1 ▪ Measured values 2 ▪ Measured values 3 ▪ Density ▪ Electronic temperature ▪ Empty pipe detection ▪ Flow velocity ▪ Low flow cut off ▪ Mass flow ▪ Reference density ▪ Corrected volume flow ▪ Temperature ▪ Status ▪ Volume flow 	
	Measured variable status			
	Quality			Bad
	Quality substatus			Maintenance alarm
	Coding (hex)			0x24 to 0x27
	Status signal			F
	Diagnostic behavior			Alarm

Diagnostic information		Remedy instructions	Influenced measured variables	
No.	Short text			
361	I/O module 1 to n faulty	1. Restart device 2. Check electronic modules 3. Change I/O Modul or main electronics	<ul style="list-style-type: none"> ■ Conductivity ■ Corrected conductivity ■ Measured values 1 ■ Measured values 2 ■ Measured values 3 ■ Density ■ Electronic temperature ■ Empty pipe detection ■ Flow velocity ■ Low flow cut off ■ Mass flow ■ Reference density ■ Corrected volume flow ■ Temperature ■ Status ■ Volume flow 	
	Measured variable status			
	Quality			Bad
	Quality substatus			Maintenance alarm
	Coding (hex)			0x24 to 0x27
	Status signal			F
	Diagnostic behavior			Alarm

Diagnostic information		Remedy instructions	Influenced measured variables	
No.	Short text			
372	Sensor electronic (ISEM) faulty	1. Restart device 2. Check if failure recurs 3. Replace sensor electronic module (ISEM)	<ul style="list-style-type: none"> ■ Conductivity ■ Corrected conductivity ■ Measured values 1 ■ Measured values 2 ■ Measured values 3 ■ Density ■ Electronic temperature ■ Empty pipe detection ■ Flow velocity ■ Low flow cut off ■ Mass flow ■ Reference density ■ Corrected volume flow ■ Temperature ■ Status ■ Volume flow 	
	Measured variable status			
	Quality			Bad
	Quality substatus			Maintenance alarm
	Coding (hex)			0x24 to 0x27
	Status signal			F
	Diagnostic behavior			Alarm

Diagnostic information		Remedy instructions	Influenced measured variables	
No.	Short text			
373	Sensor electronic (ISEM) faulty	1. Transfer data or reset device 2. Contact service	<ul style="list-style-type: none"> ■ Conductivity ■ Corrected conductivity ■ Measured values 1 ■ Measured values 2 ■ Measured values 3 ■ Density ■ Electronic temperature ■ Empty pipe detection ■ Flow velocity ■ Low flow cut off ■ Mass flow ■ Reference density ■ Corrected volume flow ■ Temperature ■ Status ■ Volume flow 	
	Measured variable status			
	Quality			Bad
	Quality substatus			Maintenance alarm
	Coding (hex)			0x24 to 0x27
	Status signal			F
	Diagnostic behavior			Alarm

Diagnostic information		Remedy instructions	Influenced measured variables	
No.	Short text			
375	I/O- 1 to n communication failed	<ol style="list-style-type: none"> Restart device Check if failure recurs Replace module rack inclusive electronic modules 	<ul style="list-style-type: none"> Conductivity Corrected conductivity Measured values 1 Measured values 2 Measured values 3 Density Electronic temperature Empty pipe detection Flow velocity Low flow cut off Mass flow Reference density Corrected volume flow Temperature Status Volume flow 	
	Measured variable status			
	Quality			Bad
	Quality substatus			Maintenance alarm
	Coding (hex)			0x24 to 0x27
	Status signal			F
	Diagnostic behavior			Alarm

Diagnostic information		Remedy instructions	Influenced measured variables	
No.	Short text			
376	Sensor electronic (ISEM) faulty	<ol style="list-style-type: none"> Replace sensor electronic module (ISEM) Turn off diagnostic message 	<ul style="list-style-type: none"> Conductivity Corrected conductivity Measured values 1 Measured values 2 Measured values 3 Density Electronic temperature Empty pipe detection Flow velocity Low flow cut off Mass flow Reference density Corrected volume flow Temperature Status Volume flow 	
	Measured variable status [from the factory] ¹⁾			
	Quality			Bad
	Quality substatus			Maintenance alarm
	Coding (hex)			0x24 to 0x27
	Status signal			S
	Diagnostic behavior			Warning

1) Diagnostic behavior can be changed. This causes the overall status of the measured variable to change.

Diagnostic information		Remedy instructions	Influenced measured variables	
No.	Short text			
377	Sensor electronic (ISEM) faulty	<ol style="list-style-type: none"> Check sensor cable and sensor Perform Heartbeat Verification Replace sensor cable or sensor 	<ul style="list-style-type: none"> Conductivity Corrected conductivity Density Electronic temperature Empty pipe detection Flow velocity Low flow cut off Mass flow Reference density Corrected volume flow Temperature Status Volume flow 	
	Measured variable status [from the factory] ¹⁾			
	Quality			Bad
	Quality substatus			Maintenance alarm
	Coding (hex)			0x24 to 0x27
	Status signal			S
	Diagnostic behavior			Warning

1) Diagnostic behavior can be changed. This causes the overall status of the measured variable to change.

Diagnostic information		Remedy instructions	Influenced measured variables	
No.	Short text			
382	Data storage	1. Insert T-DAT 2. Replace T-DAT	<ul style="list-style-type: none"> ■ Conductivity ■ Corrected conductivity ■ Measured values 1 ■ Measured values 2 ■ Measured values 3 ■ Density ■ Electronic temperature ■ Empty pipe detection ■ Flow velocity ■ Low flow cut off ■ Mass flow ■ Reference density ■ Corrected volume flow ■ Temperature ■ Status ■ Volume flow 	
	Measured variable status			
	Quality			Bad
	Quality substatus			Maintenance alarm
	Coding (hex)			0x24 to 0x27
	Status signal			F
	Diagnostic behavior			Alarm

Diagnostic information		Remedy instructions	Influenced measured variables	
No.	Short text			
383	Memory content	1. Restart device 2. Delete T-DAT via 'Reset device' parameter 3. Replace T-DAT	<ul style="list-style-type: none"> ■ Conductivity ■ Corrected conductivity ■ Measured values 1 ■ Measured values 2 ■ Measured values 3 ■ Density ■ Electronic temperature ■ Empty pipe detection ■ Flow velocity ■ Low flow cut off ■ Mass flow ■ Reference density ■ Corrected volume flow ■ Temperature ■ Status ■ Volume flow 	
	Measured variable status			
	Quality			Bad
	Quality substatus			Maintenance alarm
	Coding (hex)			0x24 to 0x27
	Status signal			F
	Diagnostic behavior			Alarm

Diagnostic information		Remedy instructions	Influenced measured variables	
No.	Short text			
387	HistoROM backup failed	Contact service organization	<ul style="list-style-type: none"> ■ Conductivity ■ Corrected conductivity ■ Measured values 1 ■ Measured values 2 ■ Measured values 3 ■ Density ■ Electronic temperature ■ Empty pipe detection ■ Flow velocity ■ Low flow cut off ■ Mass flow ■ Reference density ■ Corrected volume flow ■ Temperature ■ Status ■ Volume flow 	
	Measured variable status			
	Quality			Bad
	Quality substatus			Maintenance alarm
	Coding (hex)			0x24 to 0x27
	Status signal			F
	Diagnostic behavior			Alarm

Diagnostic information		Remedy instructions	Influenced measured variables	
No.	Short text			
512	Sensor electronic (ISEM) faulty	1. Check ECC recovery time 2. Turn off ECC	<ul style="list-style-type: none"> ▪ Conductivity ▪ Corrected conductivity ▪ Density ▪ Electronic temperature ▪ Empty pipe detection ▪ Flow velocity ▪ Low flow cut off ▪ Mass flow ▪ Reference density ▪ Corrected volume flow ▪ Temperature ▪ Status ▪ Volume flow 	
	Measured variable status			
	Quality			Bad
	Quality substatus			Maintenance alarm
	Coding (hex)			0x24 to 0x27
	Status signal			F
	Diagnostic behavior			Alarm

12.7.3 Diagnostic of configuration

Diagnostic information		Remedy instructions	Influenced measured variables	
No.	Short text			
330	Flash file invalid	1. Update firmware of device 2. Restart device	<ul style="list-style-type: none"> ▪ Conductivity ▪ Corrected conductivity ▪ Measured values 1 ▪ Measured values 2 ▪ Measured values 3 ▪ Density ▪ Electronic temperature ▪ Empty pipe detection ▪ Flow velocity ▪ Low flow cut off ▪ Mass flow ▪ Reference density ▪ Corrected volume flow ▪ Temperature ▪ Status ▪ Volume flow 	
	Measured variable status			
	Quality			Bad
	Quality substatus			Maintenance alarm
	Coding (hex)			0x24 to 0x27
	Status signal			M
	Diagnostic behavior			Warning

Diagnostic information		Remedy instructions	Influenced measured variables	
No.	Short text			
331	Firmware update failed	1. Update firmware of device 2. Restart device	<ul style="list-style-type: none"> ▪ Conductivity ▪ Corrected conductivity ▪ Measured values 1 ▪ Measured values 2 ▪ Measured values 3 ▪ Density ▪ Electronic temperature ▪ Empty pipe detection ▪ Flow velocity ▪ Low flow cut off ▪ Mass flow ▪ Reference density ▪ Corrected volume flow ▪ Temperature ▪ Volume flow 	
	Measured variable status			
	Quality			Bad
	Quality substatus			Maintenance alarm
	Coding (hex)			0x24 to 0x27
	Status signal			F
	Diagnostic behavior			Warning

Diagnostic information		Remedy instructions	Influenced measured variables	
No.	Short text			
410	Data transfer	1. Check connection 2. Retry data transfer	<ul style="list-style-type: none"> ■ Conductivity ■ Corrected conductivity ■ Measured values 1 ■ Measured values 2 ■ Measured values 3 ■ Density ■ Electronic temperature ■ Empty pipe detection ■ Flow velocity ■ Low flow cut off ■ Mass flow ■ Reference density ■ Corrected volume flow ■ Temperature ■ Status ■ Volume flow 	
	Measured variable status			
	Quality			Bad
	Quality substatus			Maintenance alarm
	Coding (hex)			0x24 to 0x27
	Status signal			F
	Diagnostic behavior			Alarm

Diagnostic information		Remedy instructions	Influenced measured variables	
No.	Short text			
412	Processing download	Download active, please wait	<ul style="list-style-type: none"> ■ Conductivity ■ Corrected conductivity ■ Density ■ Electronic temperature ■ Empty pipe detection ■ Flow velocity ■ Low flow cut off ■ Mass flow ■ Reference density ■ Corrected volume flow ■ Temperature ■ Status ■ Volume flow 	
	Measured variable status			
	Quality			Uncertain
	Quality substatus			Initial value
	Coding (hex)			0x4C to 0x4F
	Status signal			C
	Diagnostic behavior			Warning

Diagnostic information		Remedy instructions	Influenced measured variables	
No.	Short text			
431	Trim 1 to n	Carry out trim	-	
	Measured variable status			
	Quality			Good
	Quality substatus			Function check
	Coding (hex)			0xBC to 0xBF
	Status signal			C
	Diagnostic behavior			Warning

Diagnostic information		Remedy instructions	Influenced measured variables	
No.	Short text			
437	Configuration incompatible	1. Restart device 2. Contact service	<ul style="list-style-type: none"> ■ Conductivity ■ Corrected conductivity ■ Measured values 1 ■ Measured values 2 ■ Measured values 3 ■ Density ■ Electronic temperature ■ Empty pipe detection ■ Flow velocity ■ Low flow cut off ■ Mass flow ■ Reference density ■ Corrected volume flow ■ Temperature ■ Status ■ Volume flow 	
	Measured variable status			
	Quality			Bad
	Quality substatus			Maintenance alarm
	Coding (hex)			0x24 to 0x27
	Status signal			F
	Diagnostic behavior			Alarm

Diagnostic information		Remedy instructions	Influenced measured variables	
No.	Short text			
438	Dataset	1. Check data set file 2. Check device configuration 3. Up- and download new configuration	<ul style="list-style-type: none"> ■ Conductivity ■ Corrected conductivity ■ Measured values 1 ■ Measured values 2 ■ Measured values 3 ■ Density ■ Electronic temperature ■ Empty pipe detection ■ Flow velocity ■ Low flow cut off ■ Mass flow ■ Reference density ■ Corrected volume flow ■ Temperature ■ Status ■ Volume flow 	
	Measured variable status			
	Quality			Uncertain
	Quality substatus			Maintenance demanded
	Coding (hex)			0x68 to 0x6B
	Status signal			M
	Diagnostic behavior			Warning

Diagnostic information		Remedy instructions	Influenced measured variables	
No.	Short text			
441	Current output 1 to n	1. Check process 2. Check current output settings	-	
	Measured variable status [from the factory] ¹⁾			
	Quality			Good
	Quality substatus			Function check
	Coding (hex)			0xBC to 0xBF
	Status signal			S
	Diagnostic behavior			Warning

1) Diagnostic behavior can be changed. This causes the overall status of the measured variable to change.

Diagnostic information		Remedy instructions	Influenced measured variables	
No.	Short text			
442	Frequency output 1 to n	1. Check process 2. Check frequency output settings	-	
	Measured variable status [from the factory] ¹⁾			
	Quality			Good
	Quality substatus			Function check
	Coding (hex)			0xBC to 0xBF
	Status signal			S
	Diagnostic behavior			Warning

1) Diagnostic behavior can be changed. This causes the overall status of the measured variable to change.

Diagnostic information		Remedy instructions	Influenced measured variables	
No.	Short text			
443	Pulse output 1 to n	1. Check process 2. Check pulse output settings	-	
	Measured variable status [from the factory] ¹⁾			
	Quality			Good
	Quality substatus			Function check
	Coding (hex)			0xBC to 0xBF
	Status signal			S
	Diagnostic behavior			Warning

1) Diagnostic behavior can be changed. This causes the overall status of the measured variable to change.

Diagnostic information		Remedy instructions	Influenced measured variables	
No.	Short text			
444	Current input 1 to n	1. Check process 2. Check current input settings	<ul style="list-style-type: none"> ■ Measured values 1 ■ Measured values 2 ■ Measured values 3 	
	Measured variable status [from the factory] ¹⁾			
	Quality			Good
	Quality substatus			Function check
	Coding (hex)			0xBC to 0xBF
	Status signal			S
	Diagnostic behavior			Warning

1) Diagnostic behavior can be changed. This causes the overall status of the measured variable to change.

Diagnostic information		Remedy instructions	Influenced measured variables	
No.	Short text			
453	Flow override	Deactivate flow override	<ul style="list-style-type: none"> ▪ Conductivity ▪ Corrected conductivity ▪ Density ▪ Electronic temperature ▪ Empty pipe detection ▪ Flow velocity ▪ Low flow cut off ▪ Mass flow ▪ Reference density ▪ Corrected volume flow ▪ Temperature ▪ Status ▪ Volume flow 	
	Measured variable status			
	Quality			Good
	Quality substatus			Function check
	Coding (hex)			0xBC to 0xBF
	Status signal			C
	Diagnostic behavior			Warning

Diagnostic information		Remedy instructions	Influenced measured variables	
No.	Short text			
463	Analog input 1 to n selection invalid	1. Check module/channel configuration 2. Check I/O module configuration	<ul style="list-style-type: none"> ▪ Measured values 1 ▪ Measured values 2 ▪ Measured values 3 	
	Measured variable status			
	Quality			Bad
	Quality substatus			Maintenance alarm
	Coding (hex)			0x24 to 0x27
	Status signal			F
	Diagnostic behavior			Alarm

Diagnostic information		Remedy instructions	Influenced measured variables	
No.	Short text			
482	FB not Auto/Cas	Set Block in AUTO mode	-	
	Measured variable status			
	Quality			Good
	Quality substatus			Ok
	Coding (hex)			0x80 to 0x83
	Status signal			F
	Diagnostic behavior			Alarm

Diagnostic information		Remedy instructions	Influenced measured variables	
No.	Short text			
484	Failure mode simulation	Deactivate simulation	<ul style="list-style-type: none"> ▪ Conductivity ▪ Corrected conductivity ▪ Density ▪ Electronic temperature ▪ Empty pipe detection ▪ Flow velocity ▪ Low flow cut off ▪ Mass flow ▪ Reference density ▪ Corrected volume flow ▪ Temperature ▪ Status ▪ Volume flow 	
	Measured variable status			
	Quality			Bad
	Quality substatus			Function check
	Coding (hex)			0x3C to 0x3F
	Status signal			C
	Diagnostic behavior			Alarm

Diagnostic information		Remedy instructions	Influenced measured variables	
No.	Short text			
485	Measured variable simulation	Deactivate simulation	<ul style="list-style-type: none"> ■ Conductivity ■ Corrected conductivity ■ Density ■ Electronic temperature ■ Empty pipe detection ■ Flow velocity ■ Low flow cut off ■ Mass flow ■ Reference density ■ Corrected volume flow ■ Temperature ■ Status ■ Volume flow 	
	Measured variable status			
	Quality			Good
	Quality substatus			Function check
	Coding (hex)			0xBC to 0xBF
	Status signal			C
	Diagnostic behavior			Warning

Diagnostic information		Remedy instructions	Influenced measured variables	
No.	Short text			
486	Current input 1 to n simulation	Deactivate simulation	<ul style="list-style-type: none"> ■ Measured values 1 ■ Measured values 2 ■ Measured values 3 	
	Measured variable status			
	Quality			Good
	Quality substatus			Function check
	Coding (hex)			0xBC to 0xBF
	Status signal			C
	Diagnostic behavior			Warning

Diagnostic information		Remedy instructions	Influenced measured variables	
No.	Short text			
491	Current output 1 to n simulation	Deactivate simulation	-	
	Measured variable status			
	Quality			Good
	Quality substatus			Function check
	Coding (hex)			0xBC to 0xBF
	Status signal			C
	Diagnostic behavior			Warning

Diagnostic information		Remedy instructions	Influenced measured variables	
No.	Short text			
492	Simulation frequency output 1 to n	Deactivate simulation frequency output	-	
	Measured variable status			
	Quality			Good
	Quality substatus			Function check
	Coding (hex)			0xBC to 0xBF
	Status signal			C
	Diagnostic behavior			Warning

Diagnostic information		Remedy instructions	Influenced measured variables	
No.	Short text			
493	Simulation pulse output 1 to n	Deactivate simulation pulse output	-	
	Measured variable status			
	Quality			Good
	Quality substatus			Function check
	Coding (hex)			0xBC to 0xBF
	Status signal			C
	Diagnostic behavior			Warning

Diagnostic information		Remedy instructions	Influenced measured variables	
No.	Short text			
494	Switch output simulation 1 to n	Deactivate simulation switch output	-	
	Measured variable status			
	Quality			Good
	Quality substatus			Function check
	Coding (hex)			0xBC to 0xBF
	Status signal			C
	Diagnostic behavior			Warning

Diagnostic information		Remedy instructions	Influenced measured variables	
No.	Short text			
495	Diagnostic event simulation	Deactivate simulation	-	
	Measured variable status			
	Quality			Good
	Quality substatus			Ok
	Coding (hex)			0x80 to 0x83
	Status signal			C
	Diagnostic behavior			Warning

Diagnostic information		Remedy instructions	Influenced measured variables	
No.	Short text			
496	Status input simulation	Deactivate simulation status input	-	
	Measured variable status			
	Quality			Good
	Quality substatus			Function check
	Coding (hex)			0xBC to 0xBF
	Status signal			C
	Diagnostic behavior			Warning

Diagnostic information		Remedy instructions	Influenced measured variables	
No.	Short text			
497	Simulation block output		Deactivate simulation	-
	Measured variable status			
	Quality	Good		
	Quality substatus	Ok		
	Coding (hex)	0x80 to 0x83		
	Status signal	C		
	Diagnostic behavior	Warning		

Diagnostic information		Remedy instructions	Influenced measured variables	
No.	Short text			
511	ISEM settings faulty		<ol style="list-style-type: none"> 1. Check measuring period and integration time 2. Check sensor properties 	<ul style="list-style-type: none"> ■ Conductivity ■ Corrected conductivity ■ Density ■ Electronic temperature ■ Empty pipe detection ■ Flow velocity ■ Low flow cut off ■ Mass flow ■ Reference density ■ Corrected volume flow ■ Temperature ■ Status ■ Volume flow
	Measured variable status			
	Quality	Bad		
	Quality substatus	Maintenance alarm		
	Coding (hex)	0x24 to 0x27		
	Status signal	C		
	Diagnostic behavior	Alarm		

Diagnostic information		Remedy instructions	Influenced measured variables	
No.	Short text			
520	I/O 1 to n hardware configuration invalid		<ol style="list-style-type: none"> 1. Check I/O hardware configuration 2. Replace wrong I/O module 3. Plug the module of double pulse output on correct slot 	-
	Measured variable status			
	Quality	Bad		
	Quality substatus	Function check		
	Coding (hex)	0x3C to 0x3F		
	Status signal	F		
	Diagnostic behavior	Alarm		

Diagnostic information		Remedy instructions	Influenced measured variables	
No.	Short text			
530	Electrode cleaning is running		Turn off ECC	<ul style="list-style-type: none"> ■ Conductivity ■ Corrected conductivity ■ Density ■ Electronic temperature ■ Empty pipe detection ■ Flow velocity ■ Low flow cut off ■ Mass flow ■ Reference density ■ Corrected volume flow ■ Temperature ■ Status ■ Volume flow
	Measured variable status			
	Quality	Good		
	Quality substatus	Function check		
	Coding (hex)	0xBC to 0xBF		
	Status signal	C		
	Diagnostic behavior	Warning		

Diagnostic information		Remedy instructions	Influenced measured variables	
No.	Short text			
531	Empty pipe adjustment faulty	Execute EPD adjustment	<ul style="list-style-type: none"> ■ Conductivity ■ Corrected conductivity ■ Empty pipe detection ■ Flow velocity ■ Low flow cut off ■ Mass flow ■ Corrected volume flow ■ Status ■ Volume flow 	
	Measured variable status [from the factory] ¹⁾			
	Quality			Bad
	Quality substatus			Maintenance alarm
	Coding (hex)			0x24 to 0x27
	Status signal			S
	Diagnostic behavior			Warning

1) Diagnostic behavior can be changed. This causes the overall status of the measured variable to change.

Diagnostic information		Remedy instructions	Influenced measured variables	
No.	Short text			
537	Configuration	1. Check IP addresses in network 2. Change IP address	-	
	Measured variable status			
	Quality			Good
	Quality substatus			Function check
	Coding (hex)			0xBC to 0xBF
	Status signal			F
	Diagnostic behavior			Warning

Diagnostic information		Remedy instructions	Influenced measured variables	
No.	Short text			
594	Relay output simulation	Deactivate simulation switch output	-	
	Measured variable status			
	Quality			Good
	Quality substatus			Function check
	Coding (hex)			0xBC to 0xBF
	Status signal			C
	Diagnostic behavior			Warning

12.7.4 Diagnostic of process

Diagnostic information		Remedy instructions	Influenced measured variables	
No.	Short text			
803	Current loop	1. Check wiring 2. Change I/O module	-	
	Measured variable status			
	Quality			Bad
	Quality substatus			Process related
	Coding (hex)			0x28 to 0x2B
	Status signal			F
	Diagnostic behavior			Alarm

Diagnostic information		Remedy instructions	Influenced measured variables	
No.	Short text			
832	Electronic temperature too high	Reduce ambient temperature	<ul style="list-style-type: none"> ■ Conductivity ■ Corrected conductivity ■ Measured values 1 ■ Measured values 2 ■ Measured values 3 ■ Density ■ Electronic temperature ■ Empty pipe detection ■ Flow velocity ■ Low flow cut off ■ Mass flow ■ Reference density ■ Corrected volume flow ■ Temperature ■ Status ■ Volume flow 	
	Measured variable status [from the factory] ¹⁾			
	Quality			Bad
	Quality substatus			Process related
	Coding (hex)			0x28 to 0x2B
	Status signal			S
Diagnostic behavior	Warning			

1) Diagnostic behavior can be changed. This causes the overall status of the measured variable to change.

Diagnostic information		Remedy instructions	Influenced measured variables	
No.	Short text			
833	Electronic temperature too low	Increase ambient temperature	<ul style="list-style-type: none"> ■ Conductivity ■ Corrected conductivity ■ Measured values 1 ■ Measured values 2 ■ Measured values 3 ■ Density ■ Electronic temperature ■ Empty pipe detection ■ Flow velocity ■ Low flow cut off ■ Mass flow ■ Reference density ■ Corrected volume flow ■ Temperature ■ Status ■ Volume flow 	
	Measured variable status [from the factory] ¹⁾			
	Quality			Bad
	Quality substatus			Process related
	Coding (hex)			0x28 to 0x2B
	Status signal			S
Diagnostic behavior	Warning			

1) Diagnostic behavior can be changed. This causes the overall status of the measured variable to change.

Diagnostic information		Remedy instructions	Influenced measured variables	
No.	Short text			
834	Process temperature too high	Reduce process temperature	<ul style="list-style-type: none"> ■ Conductivity ■ Corrected conductivity ■ Electronic temperature ■ Empty pipe detection ■ Flow velocity ■ Low flow cut off ■ Mass flow ■ Corrected volume flow ■ Temperature ■ Status ■ Volume flow 	
	Measured variable status [from the factory] ¹⁾			
	Quality			Uncertain
	Quality substatus			Process related
	Coding (hex)			0x78 to 0x7B
	Status signal			S
Diagnostic behavior	Warning			

1) Diagnostic behavior can be changed. This causes the overall status of the measured variable to change.

Diagnostic information		Remedy instructions	Influenced measured variables	
No.	Short text			
835	Process temperature too low	Increase process temperature	<ul style="list-style-type: none"> ▪ Conductivity ▪ Corrected conductivity ▪ Electronic temperature ▪ Empty pipe detection ▪ Flow velocity ▪ Low flow cut off ▪ Mass flow ▪ Corrected volume flow ▪ Temperature ▪ Status ▪ Volume flow 	
	Measured variable status [from the factory] ¹⁾			
	Quality			Uncertain
	Quality substatus			Process related
	Coding (hex)			0x78 to 0x7B
	Status signal			S
	Diagnostic behavior			Warning

1) Diagnostic behavior can be changed. This causes the overall status of the measured variable to change.

Diagnostic information		Remedy instructions	Influenced measured variables	
No.	Short text			
842	Process limit	Low flow cut off active! 1. Check low flow cut off configuration	<ul style="list-style-type: none"> ▪ Flow velocity ▪ Mass flow ▪ Corrected volume flow ▪ Status ▪ Volume flow 	
	Measured variable status [from the factory] ¹⁾			
	Quality			Uncertain
	Quality substatus			Process related
	Coding (hex)			0x78 to 0x7B
	Status signal			S
	Diagnostic behavior			Warning

1) Diagnostic behavior can be changed. This causes the overall status of the measured variable to change.

Diagnostic information		Remedy instructions	Influenced measured variables	
No.	Short text			
882	Input signal	1. Check input configuration 2. Check external device or process conditions	<ul style="list-style-type: none"> ▪ Corrected conductivity ▪ Measured values 1 ▪ Measured values 2 ▪ Measured values 3 ▪ Density ▪ Empty pipe detection ▪ Flow velocity ▪ Low flow cut off ▪ Mass flow ▪ Reference density ▪ Corrected volume flow ▪ Temperature ▪ Status ▪ Volume flow 	
	Measured variable status			
	Quality			Bad
	Quality substatus			Maintenance alarm
	Coding (hex)			0x24 to 0x27
	Status signal			F
	Diagnostic behavior			Alarm

Diagnostic information		Remedy instructions	Influenced measured variables	
No.	Short text			
937	Sensor symmetry	1. Eliminate external magnetic field near sensor 2. Turn off diagnostic message	<ul style="list-style-type: none"> ■ Conductivity ■ Corrected conductivity ■ Density ■ Electronic temperature ■ Empty pipe detection ■ Flow velocity ■ Low flow cut off ■ Mass flow ■ Reference density ■ Corrected volume flow ■ Temperature ■ Status ■ Volume flow 	
	Measured variable status [from the factory] ¹⁾			
	Quality			Bad
	Quality substatus			Maintenance alarm
	Coding (hex)			0x24 to 0x27
	Status signal			S
	Diagnostic behavior			Warning

1) Diagnostic behavior can be changed. This causes the overall status of the measured variable to change.

Diagnostic information		Remedy instructions	Influenced measured variables	
No.	Short text			
938	EMC interference	1. Check ambient conditions regarding EMC influence 2. Turn off diagnostic message	<ul style="list-style-type: none"> ■ Conductivity ■ Corrected conductivity ■ Density ■ Electronic temperature ■ Empty pipe detection ■ Flow velocity ■ Low flow cut off ■ Mass flow ■ Reference density ■ Corrected volume flow ■ Temperature ■ Status ■ Volume flow 	
	Measured variable status [from the factory] ¹⁾			
	Quality			Bad
	Quality substatus			Maintenance alarm
	Coding (hex)			0x24 to 0x27
	Status signal			F
	Diagnostic behavior			Alarm

1) Diagnostic behavior can be changed. This causes the overall status of the measured variable to change.

Diagnostic information		Remedy instructions	Influenced measured variables	
No.	Short text			
961	Electrode potential out of specification	1. Check process conditions 2. Check ambient conditions	<ul style="list-style-type: none"> ■ Empty pipe detection ■ Low flow cut off ■ Mass flow ■ Status ■ Volume flow 	
	Measured variable status [from the factory] ¹⁾			
	Quality			Bad
	Quality substatus			Maintenance alarm
	Coding (hex)			0x24 to 0x27
	Status signal			S
	Diagnostic behavior			Warning





1) Diagnostic behavior can be changed. This causes the overall status of the measured variable to change.



No.	Diagnostic information		Remedy instructions	Influenced measured variables
	Short text			
962	Pipe empty		1. Perform full pipe adjustment 2. Perform empty pipe adjustment 3. Turn off empty pipe detection	<ul style="list-style-type: none"> ■ Conductivity ■ Corrected conductivity ■ Flow velocity ■ Low flow cut off ■ Mass flow ■ Corrected volume flow ■ Status ■ Volume flow
	Measured variable status [from the factory] ¹⁾			
	Quality	Bad		
	Quality substatus	Process related		
	Coding (hex)	0x28 to 0x2B		
	Status signal	S		
	Diagnostic behavior	Warning		

1) Diagnostic behavior can be changed. This causes the overall status of the measured variable to change.

12.8 Pending diagnostic events





The **Diagnostics** menu allows the user to view the current diagnostic event and the previous diagnostic event separately.

-  To call up the measures to rectify a diagnostic event:
 - Via local display →  145
 - Via Web browser →  146
 - Via "FieldCare" operating tool →  147
 - Via "DeviceCare" operating tool →  147

-  Other pending diagnostic events can be displayed in the **Diagnostic list** submenu →  175

Navigation

"Diagnostics" menu

 Diagnostics	
Actual diagnostics	→  174
Previous diagnostics	→  174
Operating time from restart	→  175
Operating time	→  175

Parameter overview with brief description

Parameter	Prerequisite	Description	User interface
Actual diagnostics	A diagnostic event has occurred.	Shows the current occurred diagnostic event along with its diagnostic information.  If two or more messages occur simultaneously, the message with the highest priority is shown on the display.	Symbol for diagnostic behavior, diagnostic code and short message.
Previous diagnostics	Two diagnostic events have already occurred.	Shows the diagnostic event that occurred prior to the current diagnostic event along with its diagnostic information.	Symbol for diagnostic behavior, diagnostic code and short message.

Parameter	Prerequisite	Description	User interface
Operating time from restart	-	Shows the time the device has been in operation since the last device restart.	Days (d), hours (h), minutes (m) and seconds (s)
Operating time	-	Indicates how long the device has been in operation.	Days (d), hours (h), minutes (m) and seconds (s)

12.9 Diagnostic list

Up to 5 currently pending diagnostic events can be displayed in the **Diagnostic list** submenu along with the associated diagnostic information. If more than 5 diagnostic events are pending, the events with the highest priority are shown on the display.

Navigation path

Diagnostics → Diagnostic list

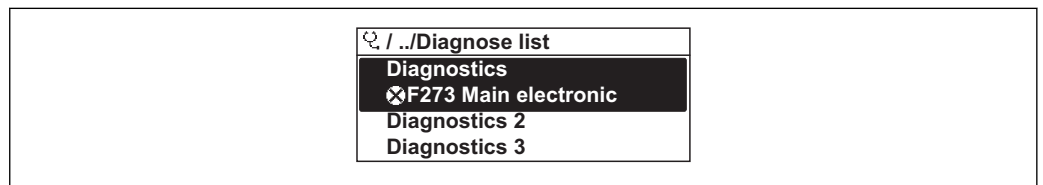

A0014006-EN

31 Taking the example of the local display

i To call up the measures to rectify a diagnostic event:

- Via local display → 145
- Via Web browser → 146
- Via "FieldCare" operating tool → 147
- Via "DeviceCare" operating tool → 147

12.10 Event logbook

12.10.1 Reading out the event logbook

A chronological overview of the event messages that have occurred is provided in the **Events list** submenu.

Navigation path

Diagnostics menu → **Event logbook** submenu → Event list

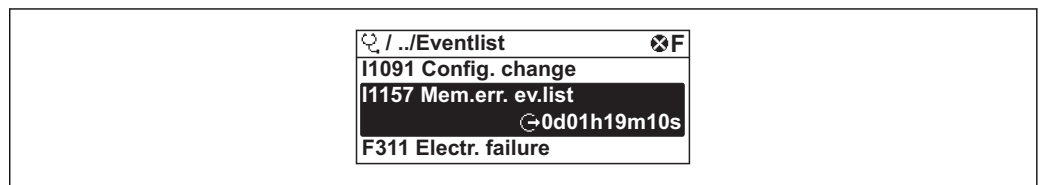

A0014008-EN

32 Taking the example of the local display

- A maximum of 20 event messages can be displayed in chronological order.
- If the **Extended HistoROM** application package (order option) is enabled in the device, the event list can contain up to 100 entries .





The event history includes entries for:

- Diagnostic events → 151
- Information events → 176

In addition to the operation time of its occurrence, each event is also assigned a symbol that indicates whether the event has occurred or is ended:

- Diagnostic event
 - ☺: Occurrence of the event
 - ☹: End of the event
- Information event
 - ☺: Occurrence of the event

 To call up the measures to rectify a diagnostic event:

- Via local display →  145
- Via Web browser →  146
- Via "FieldCare" operating tool →  147
- Via "DeviceCare" operating tool →  147

 For filtering the displayed event messages →  176

12.10.2 Filtering the event logbook

Using the **Filter options** parameter you can define which category of event message is displayed in the **Events list** submenu.

Navigation path

Diagnostics → Event logbook → Filter options

Filter categories

- All
- Failure (F)
- Function check (C)
- Out of specification (S)
- Maintenance required (M)
- Information (I)

12.10.3 Overview of information events

Unlike a diagnostic event, an information event is displayed in the event logbook only and not in the diagnostic list.

Info number	Info name
I1000	----- (Device ok)
I1079	Sensor changed
I1089	Power on
I1090	Configuration reset
I1091	Configuration changed
I1092	HistoROM backup deleted
I1137	Electronic changed
I1151	History reset
I1155	Reset electronic temperature
I1156	Memory error trend
I1157	Memory error event list
I1184	Display connected
I1256	Display: access status changed
I1278	I/O module reset detected
I1335	Firmware changed
I1351	Empty pipe detection adjustment failure

Info number	Info name
I1353	Empty pipe detection adjustment ok
I1361	Web server: login failed
I1397	Fieldbus: access status changed
I1398	CDI: access status changed
I1443	Coating thickness not determined
I1444	Device verification passed
I1445	Device verification failed
I1457	Measured error verification failed
I1459	I/O module verification failed
I1461	Sensor verification failed
I1462	Sensor electronic module verific. failed
I1512	Download started
I1513	Download finished
I1514	Upload started
I1515	Upload finished
I1618	I/O module 2 replaced
I1619	I/O module 3 replaced
I1621	I/O module 4 replaced
I1622	Calibration changed
I1624	Reset all totalizers
I1625	Write protection activated
I1626	Write protection deactivated
I1627	Web server: login successful
I1628	Display: login successful
I1629	CDI: login successful
I1631	Web server access changed
I1632	Display: login failed
I1633	CDI: login failed
I1634	Reset to factory settings
I1635	Reset to delivery settings
I1636	Fieldbus address reset
I1639	Max. switch cycles number reached
I1649	Hardware write protection activated
I1650	Hardware write protection deactivated
I1712	New flash file received
I1725	Sensor electronic module (ISEM) changed
I1726	Configuration backup failed

12.11 Resetting the measuring device

Using the **Device reset** parameter (→  123) it is possible to reset the entire device configuration or some of the configuration to a defined state.

12.11.1 Function scope of the "Device reset" parameter











Options	Description
Cancel	No action is executed and the user exits the parameter.
To delivery settings	Every parameter for which a customer-specific default setting was ordered is reset to this customer-specific value. All other parameters are reset to the factory setting.
Restart device	The restart resets every parameter whose data are in the volatile memory (RAM) to the factory setting (e.g. measured value data). The device configuration remains unchanged.
Restore S-DAT backup	Restore the data that are saved on the S-DAT. The data record is restored from the electronics memory to the S-DAT.  This option is displayed only in an alarm condition.

12.12 Device information





The **Device information** submenu contains all parameters that display different information for device identification.

Navigation

"Diagnostics" menu → Device information

► Device information	
Device tag	→  179
Serial number	→  179
Firmware version	→  179
Device name	→  179
Order code	→  179
Extended order code 1	→  179
Extended order code 2	→  179
Extended order code 3	→  179
ENP version	→  179
PROFIBUS ident number	→  179
Status PROFIBUS Master Config	→  179

Parameter overview with brief description

Parameter	Description	User interface	Factory setting
Device tag	Shows name of measuring point.	Max. 32 characters, such as letters, numbers or special characters (e.g. @, %, /).	Promag 300 PA
Serial number	Shows the serial number of the measuring device.	Max. 11-digit character string comprising letters and numbers.	–
Firmware version	Shows the device firmware version installed.	Character string in the format xx.yy.zz	–
Device name	Shows the name of the transmitter.  The name can be found on the nameplate of the transmitter.	Promag 300/500	–
Order code	Shows the device order code.  The order code can be found on the nameplate of the sensor and transmitter in the "Order code" field.	Character string composed of letters, numbers and certain punctuation marks (e.g. /).	–
Extended order code 1	Shows the 1st part of the extended order code.  The extended order code can also be found on the nameplate of the sensor and transmitter in the "Ext. ord. cd." field.	Character string	–
Extended order code 2	Shows the 2nd part of the extended order code.  The extended order code can also be found on the nameplate of the sensor and transmitter in the "Ext. ord. cd." field.	Character string	–
Extended order code 3	Shows the 3rd part of the extended order code.  The extended order code can also be found on the nameplate of the sensor and transmitter in the "Ext. ord. cd." field.	Character string	–
ENP version	Shows the version of the electronic nameplate (ENP).	Character string	2.02.00
PROFIBUS ident number	Displays the PROFIBUS identification number.	0 to FFFF	0x156C
Status PROFIBUS Master Config	Displays the status of the PROFIBUS Master configuration.	<ul style="list-style-type: none"> ■ Active ■ Not active 	Not active

12.13 Firmware history

Release date	Firmware version	Order code for "Firmware version"	Firmware changes	Documentation type	Documentation
08.2016	01.00.zz	Option 70	Original firmware	Operating Instructions	
11.2018	01.01.zz	Option 66	<ul style="list-style-type: none"> ▪ Local display - enhanced performance and data entry via text editor ▪ Optimized keypad lock for local display ▪ Web server feature update <ul style="list-style-type: none"> ▪ Support for trend data function ▪ Heartbeat function enhanced to include detailed results (page 3/4 of the report) ▪ Device configuration as PDF (parameter log, similar to FDT print) ▪ Network capability of Ethernet (service) interface ▪ Comprehensive Heartbeat feature update ▪ Local display - support for WLAN infrastructure mode ▪ Implementation of reset code 	Operating Instructions	BA01928D/06/EN/01.18

 It is possible to flash the firmware to the current version or the previous version using the service interface.

 For the compatibility of the firmware version with the previous version, the installed device description files and operating tools, observe the information about the device in the "Manufacturer's information" document.

 The manufacturer's information is available:

- In the Download Area of the Endress+Hauser web site: www.endress.com → Downloads
- Specify the following details:
 - Product root: e.g. 5W3B
The product root is the first part of the order code: see the nameplate on the device.
 - Text search: Manufacturer's information
 - Media type: Documentation – Technical Documentation

13 Maintenance

13.1 Maintenance tasks

No special maintenance work is required.

13.1.1 Exterior cleaning

When cleaning the exterior of measuring devices, always use cleaning agents that do not attack the surface of the housing or the seals.

WARNING

Cleaning agents can damage the plastic transmitter housing!

- ▶ Do not use high-pressure steam.
- ▶ Only use the permitted cleaning agents specified.

Permitted cleaning agents for the plastic transmitter housing

- Commercially available household cleaners
- Methyl alcohol or isopropyl alcohol
- Mild soap solutions

13.1.2 Interior cleaning

No interior cleaning is planned for the device.

13.1.3 Replacing seals

The sensor's seals (particularly aseptic molded seals) must be replaced periodically.

The interval between changes depends on the frequency of the cleaning cycles, the cleaning temperature and the medium temperature.

Replacement seals (accessory part) →  219

13.2 Measuring and test equipment

Endress+Hauser offers a wide variety of measuring and test equipment, such as W@M or device tests.

 Your Endress+Hauser Sales Center can provide detailed information on the services.

List of some of the measuring and testing equipment: →  184

13.3 Endress+Hauser services

Endress+Hauser offers a wide variety of services for maintenance such as recalibration, maintenance service or device tests.

 Your Endress+Hauser Sales Center can provide detailed information on the services.

14 Repair

14.1 General notes

14.1.1 Repair and conversion concept

The Endress+Hauser repair and conversion concept provides for the following:



- The measuring devices have a modular design.
- Spare parts are grouped into logical kits with the associated Installation Instructions.
- Repairs are carried out by Endress+Hauser Service or by appropriately trained customers.
- Certified devices can only be converted to other certified devices by Endress+Hauser Service or at the factory.

14.1.2 Notes for repair and conversion

For repair and modification of a measuring device, observe the following notes:

- ▶ Use only original Endress+Hauser spare parts.
- ▶ Carry out the repair according to the Installation Instructions.
- ▶ Observe the applicable standards, federal/national regulations, Ex documentation (XA) and certificates.
- ▶ Document every repair and each conversion and enter them into the *W@M* life cycle management database.

14.2 Spare parts

 Measuring device serial number:
Can be read out via the **Serial number** parameter (→  179) in the **Device information** submenu.

14.3 Endress+Hauser services

Endress+Hauser offers a wide range of services.

 Your Endress+Hauser Sales Center can provide detailed information on the services.

14.4 Return

The requirements for safe device return can vary depending on the device type and national legislation.

1. Refer to the website for more information:
<http://www.endress.com/support/return-material>
2. Return the device if repairs or a factory calibration are required, or if the wrong device was ordered or delivered.

14.5 Disposal

14.5.1 Removing the measuring device

1. Switch off the device.

⚠ WARNING**Danger to persons from process conditions.**

- ▶ Beware of hazardous process conditions such as pressure in the measuring device, high temperatures or aggressive fluids.
2. Carry out the mounting and connection steps from the "Mounting the measuring device" and "Connecting the measuring device" sections in reverse order. Observe the safety instructions.

14.5.2 Disposing of the measuring device

⚠ WARNING**Danger to personnel and environment from fluids that are hazardous to health.**

- ▶ Ensure that the measuring device and all cavities are free of fluid residues that are hazardous to health or the environment, e.g. substances that have permeated into crevices or diffused through plastic.

Observe the following notes during disposal:











- ▶ Observe valid federal/national regulations.
- ▶ Ensure proper separation and reuse of the device components.

15 Accessories

Various accessories, which can be ordered with the device or subsequently from Endress+Hauser, are available for the device. Detailed information on the order code in question is available from your local Endress+Hauser sales center or on the product page of the Endress+Hauser website: www.endress.com.

15.1 Device-specific accessories



15.1.1 For the transmitter

Accessories	Description
Proline 300 transmitter	<p>Transmitter for replacement or storage. Use the order code to define the following specifications:</p> <ul style="list-style-type: none"> ▪ Approvals ▪ Output ▪ Input ▪ Display/operation ▪ Housing ▪ Software <p> Order code: 5X3BXX</p> <p> Installation Instructions EA01263D</p>
Remote display and operating module DKX001	<ul style="list-style-type: none"> ▪ If ordered directly with the measuring device: Order code for "Display; operation", option O "Remote display 4-line illum.; 10 m (30 ft) Cable; touch control" ▪ If ordered separately: <ul style="list-style-type: none"> ▪ Measuring device: order code for "Display; operation", option M "W/o, prepared for remote display" ▪ DKX001: Via the separate product structure DKX001 ▪ If ordered subsequently: DKX001: Via the separate product structure DKX001 <p>Mounting bracket for DKX001</p> <ul style="list-style-type: none"> ▪ If ordered directly: order code for "Accessory enclosed", option RA "Mounting bracket, pipe 1/2" ▪ If ordered subsequently: order number: 71340960 <p>Connecting cable (replacement cable) Via the separate product structure: DKX002</p> <p> Further information on display and operating module DKX001 →  214.</p> <p> Special Documentation SD01763D</p>
External WLAN antenna	<p>External WLAN antenna with 1.5 m (59.1 in) connecting cable and two angle brackets. Order code for "Accessory enclosed", option P8 "Wireless antenna wide area".</p> <p> <ul style="list-style-type: none"> ▪ The external WLAN antenna is not suitable for use in hygienic applications. ▪ Further information on the WLAN interface →  74. </p> <p> Order number: 71351317</p> <p> Installation Instructions EA01238D</p>
Protective cover	<p>Is used to protect the measuring device from the effects of the weather: e.g. rainwater, excess heating from direct sunlight.</p> <p> Order number: 71343505</p> <p> Installation Instructions EA01160D</p>
Ground cable	Set, consisting of two ground cables for potential equalization.



15.1.2 For the sensor

Accessories	Description
Ground disks	<p>Are used to ground the medium in lined measuring tubes to ensure proper measurement.</p> <p> For details, see Installation Instructions EA00070D</p>

15.2 Service-specific accessories

Accessories	Description
Applicator	<p>Software for selecting and sizing Endress+Hauser measuring devices:</p> <ul style="list-style-type: none"> ▪ Choice of measuring devices for industrial requirements ▪ Calculation of all the necessary data for identifying the optimum flowmeter: e.g. nominal diameter, pressure loss, flow velocity and accuracy. ▪ Graphic illustration of the calculation results ▪ Determination of the partial order code, administration, documentation and access to all project-related data and parameters over the entire life cycle of a project. <p>Applicator is available:</p> <ul style="list-style-type: none"> ▪ Via the Internet: https://portal.endress.com/webapp/applicator ▪ As a downloadable DVD for local PC installation.
W@M	<p>W@M Life Cycle Management</p> <p>Improved productivity with information at your fingertips. Data relevant to a plant and its components is generated from the first stages of planning and during the asset's complete life cycle.</p> <p>W@M Life Cycle Management is an open and flexible information platform with online and on-site tools. Instant access for your staff to current, in-depth data shortens your plant's engineering time, speeds up procurement processes and increases plant uptime.</p> <p>Combined with the right services, W@M Life Cycle Management boosts productivity in every phase. For more information, visit www.endress.com/lifecyclemanagement</p>
FieldCare	<p>FDT-based plant asset management tool from Endress+Hauser. It can configure all smart field units in your system and helps you manage them. By using the status information, it is also a simple but effective way of checking their status and condition.</p> <p> Operating Instructions BA00027S and BA00059S</p>
DeviceCare	<p>Tool to connect and configure Endress+Hauser field devices.</p> <p> Innovation brochure IN01047S</p>

15.3 System components

Accessories	Description
Memograph M graphic data manager	<p>The Memograph M graphic data manager provides information on all the relevant measured variables. Measured values are recorded correctly, limit values are monitored and measuring points analyzed. The data are stored in the 256 MB internal memory and also on a SD card or USB stick.</p> <p> <ul style="list-style-type: none"> ▪ Technical Information TI00133R ▪ Operating Instructions BA00247R </p>
iTEMP	<p>The temperature transmitters can be used in all applications and are suitable for the measurement of gases, steam and liquids. They can be used to read in the medium temperature.</p> <p> "Fields of Activity" document FA00006T</p>

16 Technical data

16.1 Application

The measuring device is only suitable for flow measurement of liquids with a minimum conductivity of 5 $\mu\text{S}/\text{cm}$.

Depending on the version ordered, the measuring device can also measure potentially explosive, flammable, poisonous and oxidizing media.

To ensure that the device remains in proper operating condition for its service life, use the measuring device only for media against which the process-wetted materials are sufficiently resistant.

16.2 Function and system design

Measuring principle Electromagnetic flow measurement on the basis of *Faraday's law of magnetic induction*.

Measuring system The device consists of a transmitter and a sensor.
 The device is available as a compact version:
 The transmitter and sensor form a mechanical unit.
 For information on the structure of the device →  14

16.3 Input

Measured variable **Direct measured variables**

- Volume flow (proportional to induced voltage)
- Electrical conductivity

Calculated measured variables

Mass flow

Measuring range Typically $v = 0.01$ to 10 m/s (0.03 to 33 ft/s) with the specified accuracy
 Electrical conductivity: ≥ 5 $\mu\text{S}/\text{cm}$ for liquids in general

Flow characteristic values in SI units: DN 25 to 125 (1 to 4")

Nominal diameter		Recommended flow min./max. full scale value ($v \sim 0.3/10$ m/s) [dm ³ /min]	Factory settings		
[mm]	[in]		Full scale value current output ($v \sim 2.5$ m/s) [dm ³ /min]	Pulse value (~ 2 pulse/s) [dm ³]	Low flow cut off ($v \sim 0.04$ m/s) [dm ³ /min]
25	1	9 to 300	75	0.5	1
32	-	15 to 500	125	1	2
40	1 ½	25 to 700	200	1.5	3
50	2	35 to 1100	300	2.5	5
65	-	60 to 2000	500	5	8
80	3	90 to 3000	750	5	12

Nominal diameter		Recommended flow min./max. full scale value (v ~ 0.3/10 m/s) [dm ³ /min]	Factory settings		
[mm]	[in]		Full scale value current output (v ~ 2.5 m/s) [dm ³ /min]	Pulse value (~ 2 pulse/s) [dm ³]	Low flow cut off (v ~ 0.04 m/s) [dm ³ /min]
100	4	145 to 4 700	1200	10	20
125	-	220 to 7 500	1850	15	30

Flow characteristic values in SI units: DN 150 to 2400 (6 to 90")

Nominal diameter		Recommended flow min./max. full scale value (v ~ 0.3/10 m/s) [m ³ /h]	Factory settings		
[mm]	[in]		Full scale value current output (v ~ 2.5 m/s) [m ³ /h]	Pulse value (~ 2 pulse/s) [m ³]	Low flow cut off (v ~ 0.04 m/s) [m ³ /h]
150	6	20 to 600	150	0.025	2.5
200	8	35 to 1 100	300	0.05	5
250	10	55 to 1 700	500	0.05	7.5
300	12	80 to 2 400	750	0.1	10
350	14	110 to 3 300	1000	0.1	15
375	15	140 to 4 200	1200	0.15	20
400	16	140 to 4 200	1200	0.15	20
450	18	180 to 5 400	1500	0.25	25
500	20	220 to 6 600	2000	0.25	30
600	24	310 to 9 600	2500	0.3	40
700	28	420 to 13 500	3500	0.5	50
750	30	480 to 15 000	4000	0.5	60
800	32	550 to 18 000	4500	0.75	75
900	36	690 to 22 500	6000	0.75	100
1000	40	850 to 28 000	7000	1	125
-	42	950 to 30 000	8000	1	125
1200	48	1 250 to 40 000	10000	1.5	150
-	54	1 550 to 50 000	13000	1.5	200
1400	-	1 700 to 55 000	14000	2	225
-	60	1 950 to 60 000	16000	2	250
1600	-	2 200 to 70 000	18000	2.5	300
-	66	2 500 to 80 000	20500	2.5	325
1800	72	2 800 to 90 000	23000	3	350
-	78	3 300 to 100 000	28500	3.5	450
2000	-	3 400 to 110 000	28500	3.5	450
-	84	3 700 to 125 000	31000	4.5	500
2200	-	4 100 to 136 000	34000	4.5	540
-	90	4 300 to 143 000	36000	5	570
2400	-	4 800 to 162 000	40000	5.5	650

Flow characteristic values in SI units: DN 50 to 300 (2 to 12") for order code for "Design", option C "Fixed flange, without inlet/outlet runs"

Nominal diameter		Recommended flow min./max. full scale value (v ~ 0.12/5 m/s)	Factory settings		
[mm]	[in]		Full scale value current output (v ~ 2.5 m/s)	Pulse value (~ 4 pulse/s)	Low flow cut off (v ~ 0.01 m/s)
		[m ³ /h]	[m ³ /h]	[m ³]	[m ³ /h]
50	2	15 to 600 dm ³ /min	300 dm ³ /min	1.25 dm ³	1.25 dm ³ /min
65	–	25 to 1000 dm ³ /min	500 dm ³ /min	2 dm ³	2 dm ³ /min
80	3	35 to 1 500 dm ³ /min	750 dm ³ /min	3 dm ³	3.25 dm ³ /min
100	4	60 to 2 400 dm ³ /min	1200 dm ³ /min	5 dm ³	4.75 dm ³ /min
125	–	90 to 3 700 dm ³ /min	1850 dm ³ /min	8 dm ³	7.5 dm ³ /min
150	6	145 to 5 400 dm ³ /min	2 500 dm ³ /min	10 dm ³	11 dm ³ /min
200	8	220 to 9 400 dm ³ /min	5 000 dm ³ /min	20 dm ³	19 dm ³ /min
250	10	20 to 850	500	0.03	1.75
300	12	35 to 1 300	750	0.05	2.75

Flow characteristic values in US units: 1 to 48" (DN 25 to 1200)

Nominal diameter		Recommended flow min./max. full scale value (v ~ 0.3/10 m/s)	Factory settings		
[in]	[mm]		Full scale value current output (v ~ 2.5 m/s)	Pulse value (~ 2 pulse/s)	Low flow cut off (v ~ 0.04 m/s)
		[gal/min]	[gal/min]	[gal]	[gal/min]
1	25	2.5 to 80	18	0.2	0.25
–	32	4 to 130	30	0.2	0.5
1 ½	40	7 to 185	50	0.5	0.75
2	50	10 to 300	75	0.5	1.25
–	65	16 to 500	130	1	2
3	80	24 to 800	200	2	2.5
4	100	40 to 1 250	300	2	4
–	125	60 to 1 950	450	5	7
6	150	90 to 2 650	600	5	12
8	200	155 to 4 850	1 200	10	15
10	250	250 to 7 500	1 500	15	30
12	300	350 to 10 600	2 400	25	45
14	350	500 to 15 000	3 600	30	60
15	375	600 to 19 000	4 800	50	60
16	400	600 to 19 000	4 800	50	60
18	450	800 to 24 000	6 000	50	90
20	500	1 000 to 30 000	7 500	75	120
24	600	1 400 to 44 000	10 500	100	180
28	700	1 900 to 60 000	13 500	125	210
30	750	2 150 to 67 000	16 500	150	270
32	800	2 450 to 80 000	19 500	200	300

Nominal diameter		Recommended flow min./max. full scale value (v ~ 0.3/10 m/s) [gal/min]	Factory settings		
[in]	[mm]		Full scale value current output (v ~ 2.5 m/s) [gal/min]	Pulse value (~ 2 pulse/s) [gal]	Low flow cut off (v ~ 0.04 m/s) [gal/min]
36	900	3 100 to 100 000	24000	225	360
40	1000	3 800 to 125 000	30000	250	480
42	-	4 200 to 135 000	33000	250	600
48	1200	5 500 to 175 000	42000	400	600

Flow characteristic values in US units: 54 to 90" (DN 1400 to 2400)



Nominal diameter		Recommended flow min./max. full scale value (v ~ 0.3/10 m/s) [Mgal/d]	Factory settings		
[in]	[mm]		Full scale value current output (v ~ 2.5 m/s) [Mgal/d]	Pulse value (~ 2 pulse/s) [Mgal]	Low flow cut off (v ~ 0.04 m/s) [Mgal/d]
54	-	9 to 300	75	0.0005	1.3
-	1400	10 to 340	85	0.0005	1.3
60	-	12 to 380	95	0.0005	1.3
-	1600	13 to 450	110	0.0008	1.7
66	-	14 to 500	120	0.0008	2.2
72	1800	16 to 570	140	0.0008	2.6
78	-	18 to 650	175	0.0010	3.0
-	2000	20 to 700	175	0.0010	2.9
84	-	24 to 800	190	0.0011	3.2
-	2200	26 to 870	210	0.0012	3.4
90	-	27 to 910	220	0.0013	3.6
-	2400	31 to 1030	245	0.0014	4.1

Flow characteristic values in US units: 2 to 12" (DN 50 to 300) for order code for "Design", option C "Fixed flange, without inlet/outlet runs"

Nominal diameter		Recommended flow min./max. full scale value (v ~ 0.12/5 m/s) [gal/min]	Factory settings		
[in]	[mm]		Full scale value current output (v ~ 2.5 m/s) [gal/min]	Pulse value (~ 4 pulse/s) [gal]	Low flow cut off (v ~ 0.01 m/s) [gal/min]
2	50	4 to 160	75	0.3	0.35
-	65	7 to 260	130	0.5	0.6
3	80	10 to 400	200	0.8	0.8
4	100	16 to 650	300	1.2	1.25
-	125	24 to 1000	450	1.8	2
6	150	40 to 1400	600	2.5	3
8	200	60 to 2 500	1200	5	5

Nominal diameter		Recommended flow min./max. full scale value (v ~ 0.12/5 m/s)	Factory settings		
			Full scale value current output (v ~ 2.5 m/s)	Pulse value (~ 4 pulse/s)	Low flow cut off (v ~ 0.01 m/s)
[in]	[mm]	[gal/min]	[gal/min]	[gal]	[gal/min]
10	250	90 to 3 700	1 500	6	8
12	300	155 to 5 700	2 400	9	12

Recommended measuring range

 Flow limit →  203

Operable flow range Over 1000 : 1

Input signal

External measured values

To increase the accuracy of certain measured variables or to calculate the mass flow, the automation system can continuously write different measured values to the measuring device:

- Medium temperature enables temperature-compensated conductivity measurement (e.g. iTEMP)
- Reference density for calculating the mass flow

 Various pressure transmitters and temperature measuring devices can be ordered from Endress+Hauser: see "Accessories" section →  185

It is recommended to read in external measured values to calculate the corrected volume flow.

Current input

The measured values are written from the automation system to the measuring device via the current input →  190.

Digital communication

The measured values are written from the automation system to the measuring device via PROFIBUS PA.

Current input 0/4 to 20 mA

Current input	0/4 to 20 mA (active/passive)
Current span	<ul style="list-style-type: none"> ■ 4 to 20 mA (active) ■ 0/4 to 20 mA (passive)
Resolution	1 µA
Voltage drop	Typically: 0.6 to 2 V for 3.6 to 22 mA (passive)
Maximum input voltage	≤ 30 V (passive)
Open-circuit voltage	≤ 28.8 V (active)
Possible input variables	<ul style="list-style-type: none"> ■ Temperature ■ Density

Status input

Maximum input values	<ul style="list-style-type: none">▪ DC -3 to 30 V▪ If status input is active (ON): $R_i > 3 \text{ k}\Omega$
Response time	Configurable: 5 to 200 ms
Input signal level	<ul style="list-style-type: none">▪ Low signal: DC -3 to +5 V▪ High signal: DC 12 to 30 V
Assignable functions	<ul style="list-style-type: none">▪ Off▪ Reset the individual totalizers separately▪ Reset all totalizers▪ Flow override

16.4 Output

Output signal

PROFIBUS PA

PROFIBUS PA	In accordance with EN 50170 Volume 2, IEC 61158-2 (MBP), galvanically isolated
Data transmission	31.25 kbit/s
Current consumption	10 mA
Permitted supply voltage	9 to 32 V
Bus connection	With integrated reverse polarity protection

Current output 4 to 20 mA

Signal mode	Can be set to: <ul style="list-style-type: none"> ■ Active ■ Passive
Current range	Can be set to: <ul style="list-style-type: none"> ■ 4 to 20 mA NAMUR ■ 4 to 20 mA US ■ 4 to 20 mA ■ 0 to 20 mA (only with signal mode active) ■ Fixed current value
Maximum output values	22.5 mA
Open-circuit voltage	DC 28.8 V (active)
Maximum input voltage	DC 30 V (passive)
Load	0 to 700 Ω
Resolution	0.38 μA
Damping	Configurable: 0 to 999 s
Assignable measured variables	<ul style="list-style-type: none"> ■ Volume flow ■ Mass flow ■ Corrected volume flow ■ Flow velocity ■ Conductivity ■ Electronics temperature

Current output 4 to 20 mA Ex i passive

Order code	"Output; Input 2" (21), "Output; Input 3" (022): Option C: current output 4 to 20 mA Ex i passive
Signal mode	Passive
Current range	Can be set to: <ul style="list-style-type: none"> ■ 4 to 20 mA NAMUR ■ 4 to 20 mA US ■ 4 to 20 mA ■ Fixed current value
Maximum output values	22.5 mA
Maximum input voltage	DC 30 V
Load	0 to 700 Ω
Resolution	0.38 μA

Damping	Configurable: 0 to 999 s
Assignable measured variables	<ul style="list-style-type: none"> ▪ Volume flow ▪ Mass flow ▪ Corrected volume flow ▪ Flow velocity ▪ Conductivity ▪ Electronics temperature

Pulse/frequency/switch output

Function	Can be set to pulse, frequency or switch output
Version	Open collector Can be set to: <ul style="list-style-type: none"> ▪ Active ▪ Passive ▪ Passive NAMUR  Ex-i, passive
Maximum input values	DC 30 V, 250 mA (passive)
Open-circuit voltage	DC 28.8 V (active)
Voltage drop	For 22.5 mA: ≤ DC 2 V
Pulse output	
Maximum input values	DC 30 V, 250 mA (passive)
Maximum output current	22.5 mA (active)
Open-circuit voltage	DC 28.8 V (active)
Pulse width	Configurable: 0.05 to 2 000 ms
Maximum pulse rate	10 000 Impulse/s
Pulse value	Adjustable
Assignable measured variables	<ul style="list-style-type: none"> ▪ Volume flow ▪ Mass flow ▪ Corrected volume flow
Frequency output	
Maximum input values	DC 30 V, 250 mA (passive)
Maximum output current	22.5 mA (active)
Open-circuit voltage	DC 28.8 V (active)
Output frequency	Adjustable: end value frequency 2 to 10 000 Hz ($f_{\max} = 12\,500$ Hz)
Damping	Configurable: 0 to 999 s
Pulse/pause ratio	1:1
Assignable measured variables	<ul style="list-style-type: none"> ▪ Volume flow ▪ Mass flow ▪ Corrected volume flow ▪ Flow velocity ▪ Conductivity ▪ Electronics temperature
Switch output	
Maximum input values	DC 30 V, 250 mA (passive)
Open-circuit voltage	DC 28.8 V (active)
Switching behavior	Binary, conductive or non-conductive
Switching delay	Configurable: 0 to 100 s

Number of switching cycles	Unlimited
Assignable functions	<ul style="list-style-type: none"> ■ Off ■ On ■ Diagnostic behavior ■ Limit value: <ul style="list-style-type: none"> ■ Off ■ Volume flow ■ Mass flow ■ Corrected volume flow ■ Flow velocity ■ Conductivity ■ Totalizer 1-3 ■ Electronics temperature ■ Flow direction monitoring ■ Status <ul style="list-style-type: none"> ■ Empty pipe detection ■ Low flow cut off

Relay output

Function	Switch output
Version	Relay output, galvanically isolated
Switching behavior	Can be set to: <ul style="list-style-type: none"> ■ NO (normally open), factory setting ■ NC (normally closed)
Maximum switching capacity (passive)	<ul style="list-style-type: none"> ■ DC 30 V, 0.1 A ■ AC 30 V, 0.5 A
Assignable functions	<ul style="list-style-type: none"> ■ Off ■ On ■ Diagnostic behavior ■ Limit value: <ul style="list-style-type: none"> ■ Off ■ Volume flow ■ Mass flow ■ Corrected volume flow ■ Flow velocity ■ Conductivity ■ Totalizer 1-3 ■ Electronic temperature ■ Flow direction monitoring ■ Status <ul style="list-style-type: none"> ■ Empty pipe detection ■ Low flow cut off

User-configurable input/output

One specific input or output is assigned to a user-configurable input/output (configurable I/O) during device commissioning.

The following inputs and outputs are available for assignment:

- Choice of current output: 4 to 20 mA (active), 0/4 to 20 mA (passive)
- Pulse/frequency/switch output
- Choice of current input: 4 to 20 mA (active), 0/4 to 20 mA (passive)
- Status input

Signal on alarm

Depending on the interface, failure information is displayed as follows:

PROFIBUS PA

Status and alarm messages	Diagnostics in accordance with PROFIBUS PA Profile 3.02
Failure current FDE (Fault Disconnection Electronic)	0 mA

Current output 0/4 to 20 mA*4 to 20 mA*

Failure mode	Choose from: <ul style="list-style-type: none"> ▪ 4 to 20 mA in accordance with NAMUR recommendation NE 43 ▪ 4 to 20 mA in accordance with US ▪ Min. value: 3.59 mA ▪ Max. value: 22.5 mA ▪ Freely definable value between: 3.59 to 22.5 mA ▪ Actual value ▪ Last valid value
---------------------	--

0 to 20 mA

Failure mode	Choose from: <ul style="list-style-type: none"> ▪ Maximum alarm: 22 mA ▪ Freely definable value between: 0 to 20.5 mA
---------------------	---

Pulse/frequency/switch output

Pulse output	
Failure mode	Choose from: <ul style="list-style-type: none"> ▪ Actual value ▪ No pulses
Frequency output	
Failure mode	Choose from: <ul style="list-style-type: none"> ▪ Actual value ▪ 0 Hz ▪ Defined value (f_{\max} 2 to 12 500 Hz)
Switch output	
Failure mode	Choose from: <ul style="list-style-type: none"> ▪ Current status ▪ Open ▪ Closed

Relay output

Failure mode	Choose from: <ul style="list-style-type: none"> ▪ Current status ▪ Open ▪ Closed
---------------------	---

Local display

Plain text display	With information on cause and remedial measures
Backlight	Red backlighting indicates a device error.

 Status signal as per NAMUR recommendation NE 107

Interface/protocol



- Via digital communication:
PROFIBUS PA
- Via service interface
 - CDI-RJ45 service interface
 - WLAN interface

Plain text display	With information on cause and remedial measures
--------------------	---

Web browser

Plain text display	With information on cause and remedial measures
--------------------	---

Light emitting diodes (LED)

Status information	Status indicated by various light emitting diodes The following information is displayed depending on the device version: <ul style="list-style-type: none"> ▪ Supply voltage active ▪ Data transmission active ▪ Device alarm/error has occurred  Diagnostic information via light emitting diodes →  142
---------------------------	--

Low flow cut off The switch points for low flow cut off are user-selectable.

Galvanic isolation The outputs are galvanically isolated from one another and from earth (PE).

Protocol-specific data

Manufacturer ID	0x11
Ident number	0x156C
Profile version	3.02
Device description files (GSD, DTM, DD)	Information and files under: <ul style="list-style-type: none"> ▪ www.endress.com ▪ www.profibus.org
Supported functions	<ul style="list-style-type: none"> ▪ Identification & Maintenance Simplest device identification on the part of the control system and nameplate ▪ PROFIBUS upload/download Reading and writing parameters is up to ten times faster with PROFIBUS upload/download ▪ Condensed status Simplest and self-explanatory diagnostic information by categorizing diagnostic messages that occur
Configuration of the device address	<ul style="list-style-type: none"> ▪ DIP switches on the I/O electronics module ▪ Local display ▪ Via operating tools (e.g. FieldCare)

Compatibility with earlier model	<p>If the device is replaced, the measuring device Promag 300 supports the compatibility of the cyclic data with previous models. It is not necessary to adjust the engineering parameters of the PROFIBUS network with the Promag 300 GSD file.</p> <p>Earlier models:</p> <ul style="list-style-type: none"> ▪ Promag 50 PROFIBUS PA <ul style="list-style-type: none"> ▪ ID No.: 1525 (hex) ▪ Extended GSD file: EH3x1525.gsd ▪ Standard GSD file: EH3_1525.gsd ▪ Promag 53 PROFIBUS PA <ul style="list-style-type: none"> ▪ ID No.: 1527 (hex) ▪ Extended GSD file: EH3x1527.gsd ▪ Standard GSD file: EH3_1527.gsd
System integration	<p>Information regarding system integration →  84.</p> <ul style="list-style-type: none"> ▪ Cyclic data transmission ▪ Block model ▪ Description of the modules

16.5 Power supply

Terminal assignment →  39

Device plugs available →  39

Pin assignment, device plug →  39

Supply voltage	Order code for "Power supply"		Terminal voltage	Frequency range
Option D	DC24 V		±20%	-
Option E	AC100 to 240 V		-15...+10%	50/60 Hz, ±4 Hz
Option I	DC24 V		±20%	-
	AC100 to 240 V		-15...+10%	50/60 Hz, ±4 Hz

Power consumption **Transmitter**
Max. 10 W (active power)

switch-on current	Max. 36 A (<5 ms) as per NAMUR Recommendation NE 21
--------------------------	---

Current consumption **Transmitter**

- Max. 400 mA (24 V)
- Max. 200 mA (110 V, 50/60 Hz; 230 V, 50/60 Hz)

Power supply failure

- Totalizers stop at the last value measured.
- Depending on the device version, the configuration is retained in the device memory or in the pluggable data memory (HistoROM DAT).
- Error messages (incl. total operated hours) are stored.

Electrical connection →  41

Potential equalization →  44

terminals Spring-loaded terminals: Suitable for strands and strands with ferrules.
Conductor cross-section 0.2 to 2.5 mm² (24 to 12 AWG).

Cable entries

- Cable gland: M20 × 1.5 with cable Ø 6 to 12 mm (0.24 to 0.47 in)
- Thread for cable entry:
 - NPT ½"
 - G ½"
 - M20
- Device plug for digital communication: M12

Cable specification →  36

16.6 Performance characteristics

Reference operating conditions

- Error limits following DIN EN 29104, in future ISO 20456
- Water, typically: +15 to +45 °C (+59 to +113 °F); 0.5 to 7 bar (73 to 101 psi)
- Data as indicated in the calibration protocol
- Accuracy based on accredited calibration rigs according to ISO 17025

Maximum measured error o.r. = of reading

Error limits under reference operating conditions

Volume flow

- ±0.5 % o.r. ± 1 mm/s (0.04 in/s)
- Optional: ±0.2 % o.r. ± 2 mm/s (0.08 in/s)

Order code for "Design"	Installation <i>with</i> inlet and outlet runs max. measured error		Installation <i>without</i> inlet and outlet runs max. measured error
	0.5 %	0.2 %	0.5 %
Options D, E, F, G (standard)	✔	✔	not recommended
Options C, H, I (0 x DN)	✔	✔	✔

 Fluctuations in the supply voltage do not have any effect within the specified range.

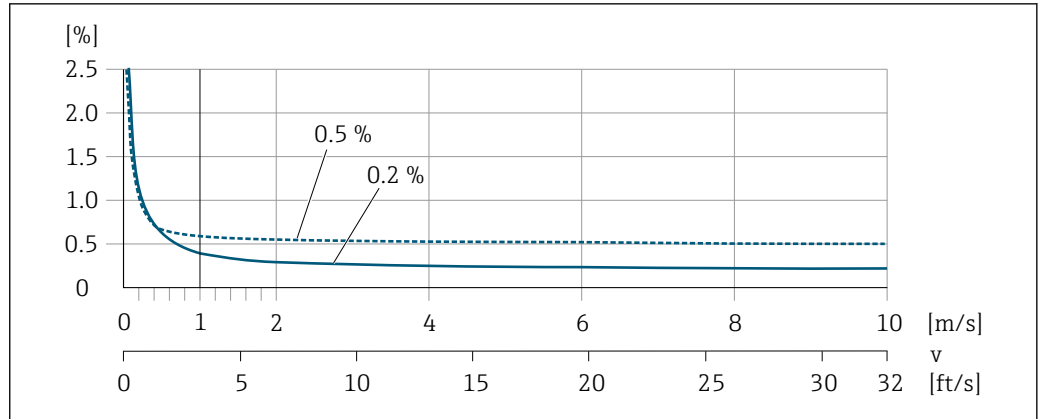

A0028974

33 Maximum measured error in % o.r.

Flat Spec

For Flat Spec in the range $v_{0.5}$ ($v_{0.2}$) up to v_{max} the measured error is constant.

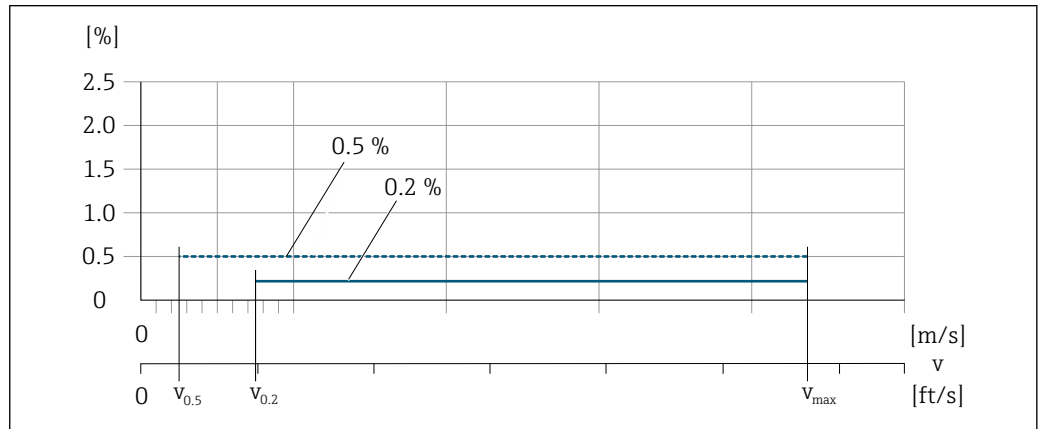

A0017051

34 Flat Spec in % o.r.

Flat Spec flow values 0.5 %

Nominal diameter		$v_{0.5}$		v_{max}	
[mm]	[in]	[m/s]	[ft/s]	[m/s]	[ft/s]
25 to 600	1 to 24	0.5	1.64	10	32
50 to 300 ¹⁾	2 to 12	0.25	0.82	5	16

1) Order code for "Design", option C

Flat Spec flow values 0.2 %

Nominal diameter		$v_{0.2}$		v_{max}	
[mm]	[in]	[m/s]	[ft/s]	[m/s]	[ft/s]
25 to 600	1 to 24	1.5	4.92	10	32
50 to 300 ¹⁾	2 to 12	0.6	1.97	4	13

1) Order code for "Design", option C

Electrical conductivity

Max. measured error not specified.

Accuracy of outputs

The outputs have the following base accuracy specifications.

Current output

Accuracy	±5 µA
-----------------	-------

Pulse/frequency output

o.r. = of reading

Accuracy	Max. ±50 ppm o.r. (over the entire ambient temperature range)
-----------------	---

Repeatability o.r. = of reading

Volume flow

Max. ±0.1 % o.r. ± 0.5 mm/s (0.02 in/s)

Electrical conductivity

Max. ±5 % o.r.

Influence of ambient temperature

Current output

Temperature coefficient	Max. 1 µA/°C
--------------------------------	--------------

Pulse/frequency output

Temperature coefficient	No additional effect. Included in accuracy.
--------------------------------	---

16.7 Installation

Chapter "Mounting requirements" →  21

16.8 Environment

Ambient temperature range →  23

Storage temperature The storage temperature corresponds to the operating temperature range of the transmitter and the sensor →  23.

- Protect the measuring device against direct sunlight during storage in order to avoid unacceptably high surface temperatures.
- Select a storage location where moisture cannot collect in the measuring device as fungus or bacteria infestation can damage the liner.
- If protection caps or protective covers are mounted these should never be removed before installing the measuring device.

Degree of protection **Measuring device**

- As standard: IP66/67, type 4X enclosure
- When housing is open: IP20, type 1 enclosure
- Display module: IP20, type 1 enclosure

External WLAN antenna
IP67

Vibration- and shock-
resistance

Vibration sinusoidal, in accordance with IEC 60068-2-6

- 2 to 8.4 Hz, 3.5 mm peak
- 8.4 to 2 000 Hz, 1 g peak

Vibration broad-band random, according to IEC 60068-2-64

- 10 to 200 Hz, 0.003 g²/Hz
- 200 to 2 000 Hz, 0.001 g²/Hz
- Total: 1.54 g rms

Shock half-sine, according to IEC 60068-2-27

6 ms 30 g

Rough handling shocks according to IEC 60068-2-31

Mechanical load

- Protect the transmitter housing against mechanical effects, such as shock or impact; the use of the remote version is sometimes preferable.
- Never use the transmitter housing as a ladder or climbing aid.

Electromagnetic
compatibility (EMC)

As per IEC/EN 61326 and NAMUR Recommendation 21 (NE 21)



Details are provided in the Declaration of Conformity.

16.9 Process

Medium temperature range

- 0 to +80 °C (+32 to +176 °F) for hard rubber, DN 50 to 2400 (2 to 90")
- -20 to +50 °C (-4 to +122 °F) for polyurethane, DN 25 to 1200 (1 to 48")
- -20 to +90 °C (-4 to +194 °F) for PTFE, DN 25 to 300 (1 to 12")

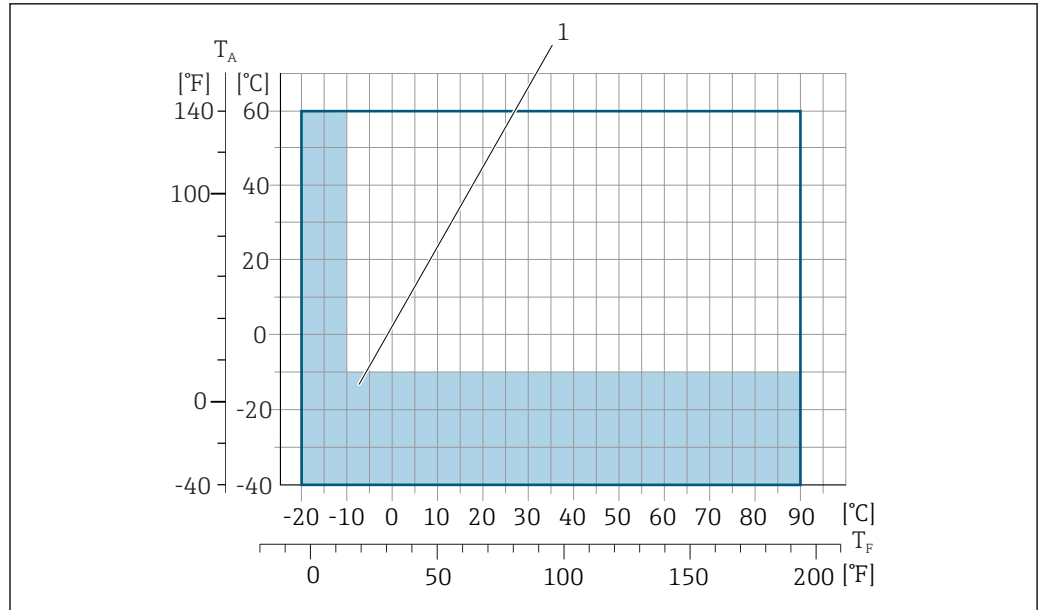

A0038130

T_A Ambient temperature range

T_F Medium temperature

1 Colored area: the ambient temperature range of -10 to -40 °C ($+14$ to -40 °F) and the fluid temperature range of -10 to -20 °C ($+14$ to -4 °F) applies to stainless flanges only

Conductivity $\geq 5 \mu\text{S/cm}$ for liquids in general.

Pressure-temperature ratings  An overview of the pressure-temperature ratings for the process connections is provided in the "Technical Information" document

Pressure tightness *Liner: hard rubber*

Nominal diameter		Limit values for absolute pressure in [mbar] ([psi]) for medium temperatures:		
[mm]	[in]	+25 °C (+77 °F)	+50 °C (+122 °F)	+80 °C (+176 °F)
50 ... 2400	2 ... 90	0 (0)	0 (0)	0 (0)

Liner: polyurethane

Nominal diameter		Limit values for absolute pressure in [mbar] ([psi]) for medium temperatures:	
[mm]	[in]	+25 °C (+77 °F)	+50 °C (+122 °F)
25 ... 1200	1 ... 48	0 (0)	0 (0)

Liner: PTFE

Nominal diameter		Limit values for absolute pressure in [mbar] ([psi]) for medium temperatures:	
[mm]	[in]	+25 °C (+77 °F)	+90 °C (+194 °F)
25	1	0 (0)	0 (0)
40	2	0 (0)	0 (0)
50	2	0 (0)	0 (0)
65	2 ½	0 (0)	40 (0.58)
80	3	0 (0)	40 (0.58)
100	4	0 (0)	135 (2.0)

Nominal diameter		Limit values for absolute pressure in [mbar] ([psi]) for medium temperatures:	
[mm]	[in]	+25 °C (+77 °F)	+90 °C (+194 °F)
125	5	135 (2.0)	240 (3.5)
150	6	135 (2.0)	240 (3.5)
200	8	200 (2.9)	290 (4.2)
250	10	330 (4.8)	400 (5.8)
300	12	400 (5.8)	500 (7.3)

Flow limit

The diameter of the pipe and the flow rate determine the nominal diameter of the sensor. The optimum velocity of flow is between 2 to 3 m/s (6.56 to 9.84 ft/s). Also match the velocity of flow (v) to the physical properties of the fluid:

- $v < 2 \text{ m/s}$ (6.56 ft/s): for abrasive fluids (e.g. potter's clay, lime milk, ore slurry)
- $v > 2 \text{ m/s}$ (6.56 ft/s): for fluids producing buildup (e.g. wastewater sludge)

i A necessary increase in the flow velocity can be achieved by reducing the sensor nominal diameter.

i For an overview of the full scale values for the measuring range, see the "Measuring range" section

Pressure loss

- No pressure loss occurs if the sensor is installed in a pipe with the same nominal diameter.
- Pressure losses for configurations incorporating adapters according to DIN EN 545
→ 25

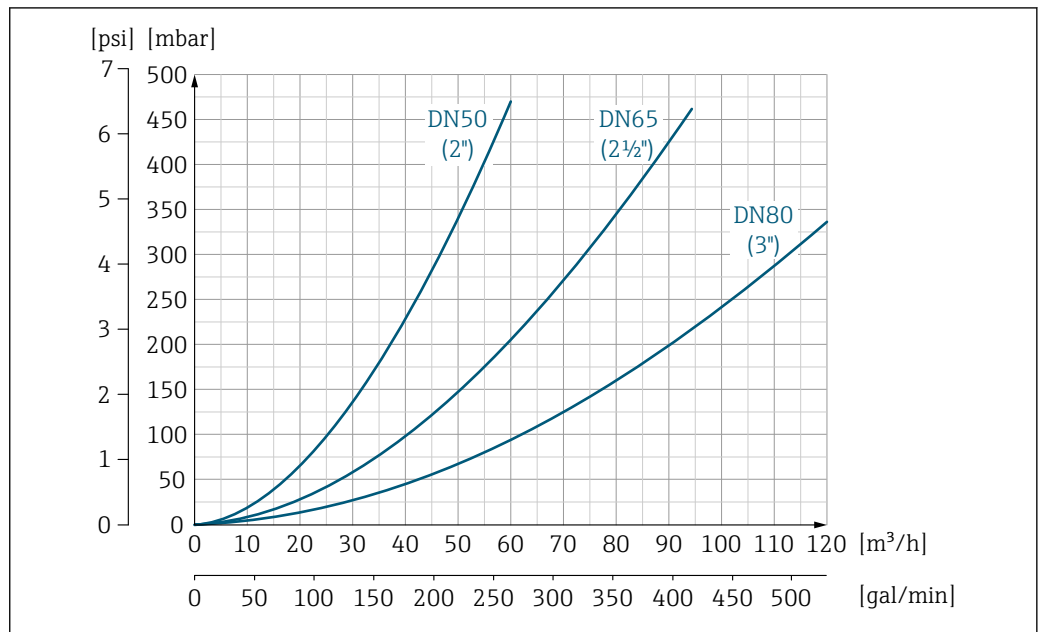

35 Pressure loss DN 50 to 80 (2 to 3") for order code for "Design", option C "fixed flange, without inlet/outlet runs"

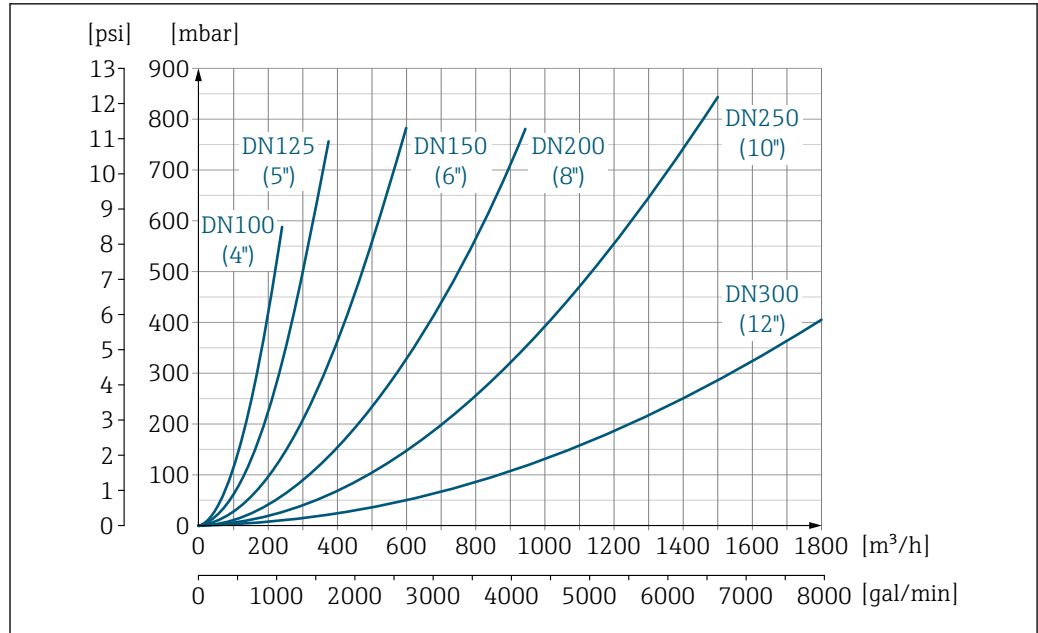

36 Pressure loss DN 100 to 300 (4 to 12") for order code for "Design", option C "fixed flange, without inlet/outlet runs"

System pressure → 24

Vibrations → 24

16.10 Mechanical construction

Design, dimensions

For the dimensions and installation lengths of the device, see the "Technical Information" document, "Mechanical construction" section.

Weight

All values (weight exclusive of packaging material) refer to devices with flanges of the standard pressure rating.

The weight may be lower than indicated depending on the pressure rating and design. Weight specifications including transmitter as per order code for "Housing", option A "Aluminum, coated".

Different values due to different transmitter versions:

Transmitter version for the hazardous area

(Order code for "Housing", option A "Aluminum, coated"; Ex d): +2 kg (+4.4 lbs)

Weight in SI units

Order code for "Design", options C, D, E DN 25 to 400, DN 1" to 16"				
Nominal diameter		Reference values		
		EN (DIN), AS, JIS		ASME (Class 150)
[mm]	[in]	Pressure rating	[kg]	[kg]
25	1	PN 40	10	5
32	-	PN 40	11	-
40	1 ½	PN 40	12	7
50	2	PN 40	13	9
65	-	PN 16	13	-
80	3	PN 16	15	14
100	4	PN 16	18	19
125	-	PN 16	25	-
150	6	PN 16	31	33
200	8	PN 10	52	52
250	10	PN 10	81	90
300	12	PN 10	95	129
350	14	PN 6	106	172
375	15	PN 6	121	-
400	16	PN 6	121	203

Order code for "Design", options F ≥ DN 450 (18")				
Nominal diameter		Reference values		
		EN (DIN) (PN16)	AS (PN 16)	ASME (Class 150), AWWA (Class D)
[mm]	[in]	[kg]	[kg]	[kg]
450	18	142	138	191
500	20	182	186	228
600	24	227	266	302
700	28	291	369	266
-	30	-	447	318
800	32	353	524	383
900	36	444	704	470
1000	40	566	785	587
-	42	-	-	670

Order code for "Design", options F ≥ DN 450 (18")				
Nominal diameter		Reference values		
		EN (DIN) (PN16)	AS (PN 16)	ASME (Class 150), AWWA (Class D)
[mm]	[in]	[kg]	[kg]	[kg]
1200	48	843	1229	901
-	54	-	-	1273
1400	-	1204	-	-
-	60	-	-	1594
1600	-	1845	-	-
-	66	-	-	2131
1800	72	2357	-	2568
-	78	2929	-	3113
2000	-	2929	-	3113
-	84	-	-	3755
2200	-	3422	-	-
-	90	-	-	4797
2400	-	4094	-	-

Order code for "Design", options G ≥ DN 450 (18")				
Nominal diameter		Reference values		
		EN (DIN) (PN 6)	ASME (Class 150), AWWA (Class D)	
[mm]	[in]	[kg]	[kg]	
450	18	161	255	
500	20	156	285	
600	24	208	405	
700	28	304	400	
-	30	-	460	
800	32	357	550	
900	36	485	800	
1000	40	589	900	
-	42	-	1100	
1200	48	850	1400	
-	54	850	2200	
1400	-	1300	-	
-	60	-	2700	
1600	-	1845	-	
-	66	-	3700	
1800	72	2357	4100	
-	78	2929	4600	
2000	-	2929	-	

Weight in US units

Order code for "Design", options C, D, E DN 25 to 400, DN 1" to 16"		
Nominal diameter		Reference values ASME (Class 150)
[mm]	[in]	[lb]
25	1	11
32	-	-
40	1 ½	15
50	2	20
65	-	-
80	3	31
100	4	42
125	-	-
150	6	73
200	8	115
250	10	198
300	12	284
350	14	379
375	15	-
400	16	448

Order code for "Design", options F ≥ DN 450 (18")		
Nominal diameter		Reference values ASME (Class 150), AWWA (Class D)
[mm]	[in]	[lb]
450	18	421
500	20	503
600	24	666
700	28	587
-	30	701
800	32	845
900	36	1036
1000	40	1294
-	42	1477
1200	48	1987
-	54	2807
1400	-	-
-	60	3515
1600	-	-
-	66	4699
1800	72	5662
-	78	6864

Order code for "Design", options F ≥ DN 450 (18")		
Nominal diameter		Reference values ASME (Class 150), AWWA (Class D)
[mm]	[in]	[lb]
2000	-	6864
-	84	8280
2200	-	-
-	90	10577
2400	-	-

Order code for "Design", options G ≥ DN 450 (18")		
Nominal diameter		Reference values ASME (Class 150), AWWA (Class D)
[mm]	[in]	[lb]
450	18	562
500	20	628
600	24	893
700	28	882
-	30	1014
800	32	1213
900	36	1764
1000	40	1984
-	42	2426
1200	48	3087
-	54	4851
1400	-	-
-	60	5954
1600	-	-
-	66	8158
1800	72	9040
-	78	10143
2000	-	-

Measuring tube specification

Nominal diameter		EN (DIN)	Pressure rating			Measuring tube internal diameter					
[mm]	[in]		ASME AWWA	AS 2129 AS 4087	JIS	Hard rubber		Polyurethane		PTFE	
[mm]	[in]					[mm]	[in]	[mm]	[in]	[mm]	[in]
25	1	PN 40	Class 150	-	20K	-	-	24	0.94	25	0.98
32	-	PN 40	-	-	20K	-	-	32	1.26	34	1.34
40	1 ½	PN 40	Class 150	-	20K	-	-	38	1.50	40	1.57
50	2	PN 40	Class 150	Table E, PN 16	10K	50	1.97	50	1.97	52	2.05

Nominal diameter		Pressure rating				Measuring tube internal diameter					
		EN (DIN)	ASME AWWA	AS 2129 AS 4087	JIS	Hard rubber		Polyurethane		PTFE	
[mm]	[in]					[mm]	[in]	[mm]	[in]	[mm]	[in]
50 ¹⁾	2	PN 40	Class 150	Table E, PN 16	10K	32	1.26	-	-	-	-
65	-	PN 16	-	-	10K	66	2.60	66	2.60	68	2.68
65 ¹⁾	-	PN 16	-	-	10K	38	1.50	-	-	-	-
80	3	PN 16	Class 150	Table E, PN 16	10K	79	3.11	79	3.11	80	3.15
80 ¹⁾	3	PN 16	Class 150	Table E, PN 16	10K	50	1.97	-	-	-	-
100	4	PN 16	Class 150	Table E, PN 16	10K	102	4.02	102	4.02	104	4.09
100 ¹⁾	4	PN 16	Class 150	Table E, PN 16	10K	66	2.60	-	-	-	-
125	-	PN 16	-	-	10K	127	5.00	127	5.00	130	5.12
125 ¹⁾	-	PN 16	-	-	10K	79	3.11	-	-	-	-
150	6	PN 16	Class 150	Table E, PN 16	10K	156	6.14	156	6.14	156	6.14
150 ¹⁾	6	PN 16	Class 150	Table E, PN 16	10K	102	4.02	-	-	-	-
200	8	PN 10	Class 150	Table E, PN 16	10K	204	8.03	204	8.03	202	7.95
200 ¹⁾	8	PN 16	Class 150	Table E, PN 16	10K	127	5.00	-	-	-	-
250	10	PN 10	Class 150	Table E, PN 16	10K	258	10.2	258	10.2	256	10.08
250 ¹⁾	10	PN 16	Class 150	Table E, PN 16	10K	156	6.14	-	-	-	-
300	12	PN 10	Class 150	Table E, PN 16	10K	309	12.2	309	12.2	306	12.05
300 ¹⁾	12	PN 16	Class 150	Table E, PN 16	10K	204	8.03	-	-	-	-
350	14	PN 6	Class 150	Table E, PN 16	10K	337	13.3	342	13.5	-	-
375	15	-	-	PN 16	10K	389	15.3	-	-	-	-
400	16	PN 6	Class 150	Table E, PN 16	10K	387	15.2	392	15.4	-	-
450	18	PN 6	Class 150	-	10K	436	17.1	437	17.2	-	-
500	20	PN 6	Class 150	Table E, PN 16	10K	487	19.1	492	19.4	-	-
600	24	PN 6	Class 150	Table E, PN 16	10K	589	23.0	594	23.4	-	-
700	28	PN 6	Class D	Table E, PN 16	10K	688	27.1	692	27.2	-	-
750	30	-	Class D	Table E, PN 16	10K	737	29.1	742	29.2	-	-
800	32	PN 6	Class D	Table E, PN 16	-	788	31.0	794	31.3	-	-
900	36	PN 6	Class D	Table E, PN 16	-	889	35.0	891	35.1	-	-
1000	40	PN 6	Class D	Table E, PN 16	-	991	39.0	994	39.1	-	-
-	42	-	Class D	-	-	1043	41.1	1043	41.1	-	-
1200	48	PN 6	Class D	Table E, PN 16	-	1191	46.9	1197	47.1	-	-
-	54	-	Class D	-	-	1339	52.7	-	-	-	-
1400	-	PN 6	-	-	-	1402	55.2	-	-	-	-
-	60	-	Class D	-	-	1492	58.7	-	-	-	-
1600	-	PN 6	-	-	-	1600	63.0	-	-	-	-
-	66	-	Class D	-	-	1638	64.5	-	-	-	-
1800	72	PN 6	-	-	-	1786	70.3	-	-	-	-
-	78	-	Class D	-	-	1989	78.3	-	-	-	-
2000	-	PN 6	-	-	-	1989	78.3	-	-	-	-
-	84	-	Class D	-	-	2099	84.0	-	-	-	-
2200	-	PN 6	-	-	-	2194	87.8	-	-	-	-

Nominal diameter		Pressure rating				Measuring tube internal diameter					
		EN (DIN)	ASME AWWA	AS 2129 AS 4087	JIS	Hard rubber		Polyurethane		PTFE	
[mm]	[in]					[mm]	[in]	[mm]	[in]	[mm]	[in]
-	90	-	Class D	-	-	2 246	89.8	-	-	-	-
2400	-	PN 6	-	-	-	2 391	94.1	-	-	-	-

1) Order code for "Design", option C

Materials

Transmitter housing

Order code for "Housing":

Option A "Aluminum, coated": aluminum, AlSi10Mg, coated

Window material

Order code for "Housing":

Option A "Aluminum, coated": glass

Cable entries/cable glands

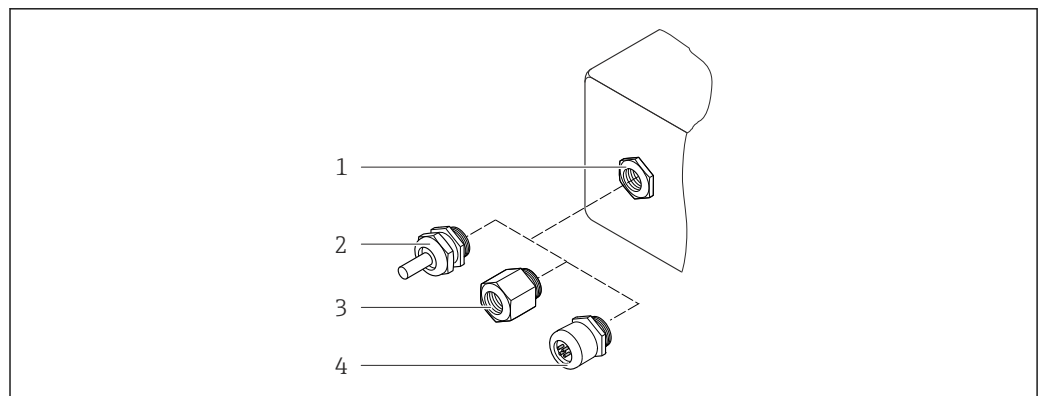

37 Possible cable entries/cable glands

- 1 Female thread M20 × 1.5
- 2 Cable gland M20 × 1.5
- 3 Adapter for cable entry with internal thread G ½" or NPT ½"
- 4 Device plugs

Order code for "Housing", option A "Aluminum, coated"

The various cable entries are suitable for hazardous and non-hazardous areas.

Cable entry/cable gland	Material
Coupling M20 × 1.5	Non-Ex: plastic
	Z2, D2, Ex d/de: brass with plastic
Adapter for cable entry with internal thread G ½"	Nickel-plated brass
Adapter for cable entry with internal thread NPT ½"	

Device plug

Electrical connection	Material
Plug M12x1	<ul style="list-style-type: none"> ▪ Socket: Stainless steel, 1.4404 (316L) ▪ Contact housing: Polyamide ▪ Contacts: Gold-plated brass

Sensor housing

- DN 25 to 300 (1 to 12")
Aluminum half-shell housing, aluminum, AlSi10Mg, coated
- DN 350 to 2400 (14 to 90")
Fully welded carbon steel housing with protective varnish

Measuring tubes

- DN 25 to 600 (1 to 24")
Stainless steel: 1.4301, 1.4306, 304, 304L
- DN 700 to 2400 (28 to 90")
Stainless steel: 1.4301, 304



Liner

- DN 25 to 300 (1 to 12"): PTFE
- DN 25 to 1200 (1 to 48"): polyurethane
- DN 50 to 2400 (2 to 90"): hard rubber

Electrodes

- Stainless steel, 1.4435 (316L)
- Alloy C22, 2.4602 (UNS N06022)
- Tantalum

Process connections

-  For flanges made of carbon steel:
 - DN ≤ 300 (12"): with Al/Zn protective coating or protective varnish
 - DN ≥ 350 (14"): protective varnish
-  All carbon steel lap joint flanges are supplied with a hot-dip galvanized finish.

*EN 1092-1 (DIN 2501)***Fixed flange**

- Carbon steel:
 - DN ≤ 300: S235JRG2, S235JR+N, P245GH, A105, E250C
 - DN 350 to 2400: P245GH, S235JRG2, A105, E250C
- Stainless steel:
 - DN ≤ 300: 1.4404, 1.4571, F316L
 - DN 350 to 600: 1.4571, F316L, 1.4404
 - DN 700 to 1000: 1.4404, F316L

Lap joint flange

- Carbon steel DN ≤ 300: S235JRG2, A105, E250C
- Stainless steel DN ≤ 300: 1.4306, 1.4404, 1.4571, F316L

Lap joint flange, stamped plate

- Carbon steel DN ≤ 300: S235JRG2 similar to S235JR+AR or 1.0038
- Stainless steel DN ≤ 300: 1.4301 similar to 304

ASME B16.5

Fixed flange, lap joint flange

- Carbon steel: A105
- Stainless steel: F316L

JIS B2220

- Carbon steel: A105, A350 LF2
- Stainless steel: F316L

AWWA C207

Carbon steel: A105, P265GH, A181 Class 70, E250C, S275JR

AS 2129

Carbon steel: A105, E250C, P235GH, P265GH, S235JRG2

AS 4087

Carbon steel: A105, P265GH, S275JR

Seals

As per DIN EN 1514-1, form IBC

Accessories*Protective cover*

Stainless steel, 1.4404 (316L)

External WLAN antenna

- Antenna: ASA plastic (acrylic ester-styrene-acrylonitrile) and nickel-plated brass
- Adapter: Stainless steel and nickel-plated brass
- Cable: Polyethylene
- Plug: Nickel-plated brass
- Angle bracket: Stainless steel

Ground disks

- Stainless steel, 1.4435 (316L)
- Alloy C22, 2.4602 (UNS N06022)
- Tantalum

Fitted electrodes



Measurement, reference and empty pipe detection electrodes available as standard with:

- 1.4435 (316L)
- Alloy C22, 2.4602 (UNS N06022)
- Tantalum

Process connections

- EN 1092-1 (DIN 2501)
 - DN ≤ 300: fixed flange (PN 10/16/25/40) = Form A, lap joint flange (PN 10/16), lap joint flange, stamped plate (PN 10) = Form A
 - DN ≥ 350: fixed flange (PN 6/10/16/25) = flat face (Form B)
 - DN 450 to 2400: fixed flange (PN 6/10/16) = flat face (Form B)
- ASME B16.5
 - DN 350 to 2400 (14 to 90"): fixed flange (Class 150)
 - DN 25 to 600 (1 to 24"): lap joint flange (Class 150)
 - DN 25 to 150 (1 to 6"): fixed flange (Class 300)
- JIS B2220
 - DN 50 to 750: fixed flange (10K)
 - DN 25 to 600: fixed flange (20K)

- AWWA C207
DN 48 to 90": fixed flange (Class D)
- AS 2129
DN 50 to 1200: fixed flange (Table E)
- AS 4087
DN 50 to 1200): fixed flange (PN 16)

 For information on the different materials used in the process connections →  211

Surface roughness Electrodes with 1.4435 (316L); Alloy C22, 2.4602 (UNS N06022); tantalum:
≤ 0.3 to 0.5 μm (11.8 to 19.7 μin)
(All data relate to parts in contact with fluid)

16.11 Human interface

Languages Can be operated in the following languages:

- Via local operation
English, German, French, Spanish, Italian, Dutch, Portuguese, Polish, Russian, Turkish, Chinese, Japanese, Korean, Bahasa (Indonesian), Vietnamese, Czech, Swedish
- Via Web browser
English, German, French, Spanish, Italian, Dutch, Portuguese, Polish, Russian, Turkish, Chinese, Japanese, Korean, Bahasa (Indonesian), Vietnamese, Czech, Swedish
- Via "FieldCare", "DeviceCare" operating tool: English, German, French, Spanish, Italian, Chinese, Japanese

Local operation **Via display module**

Equipment:

- Order code for "Display; operation", option F "4-line, illuminated, graphic display; touch control"
- Order code for "Display; operation", option G "4-line, illuminated, graphic display; touch control + WLAN"

 Information about WLAN interface →  74

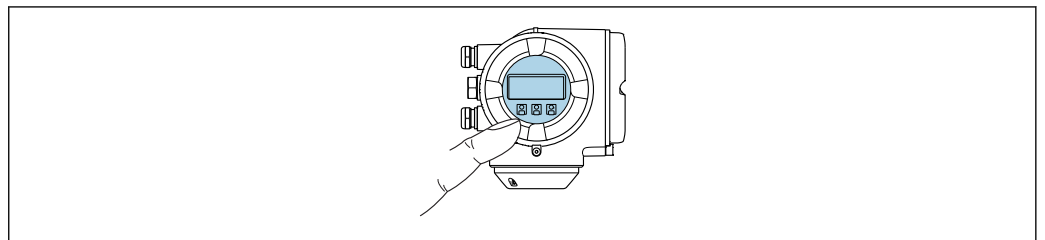

 38 Operation with touch control

Display elements

- 4-line, illuminated, graphic display
- White background lighting; switches to red in event of device errors
- Format for displaying measured variables and status variables can be individually configured
- Permitted ambient temperature for the display: -20 to +60 °C (-4 to +140 °F)
The readability of the display may be impaired at temperatures outside the temperature range.

Operating elements

- External operation via touch control (3 optical keys) without opening the housing: ☒, ☑, ☒
- Operating elements also accessible in the various zones of the hazardous area

Via remote display and operating module DKX001

i The remote display and operating module DKX001 is available as an optional extra → 184.

- The measuring device is always supplied with a dummy cover when the remote display and operating module DKX001 is ordered directly with the measuring device. Display or operation at the transmitter is not possible in this case.
- If ordered subsequently, the remote display and operating module DKX001 may not be connected at the same time as the existing measuring device display module. Only one display or operation unit may be connected to the transmitter at any one time.

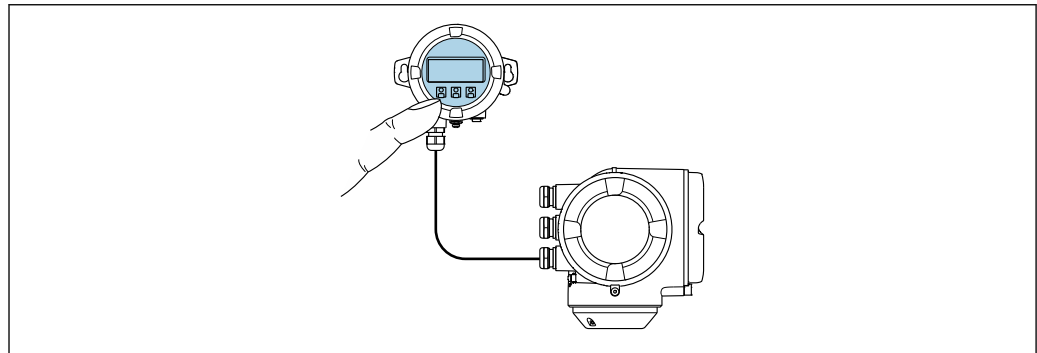

A0026786

39 *Operation via remote display and operating module DKX001*

Display and operating elements

The display and operating elements correspond to those of the display module → 213.

Housing material

Transmitter housing		Remote display and operating module
Order code for "Housing"	Material	Material
Option A "Aluminum, coated"	AlSi10Mg, coated	AlSi10Mg, coated

Cable entry

Corresponds to the choice of transmitter housing, order code for "Electrical connection".

Connecting cable

→ 37



Dimensions

i Information on the dimensions:
 "Mechanical construction" section of the "Technical Information" document.

Remote operation → 73

Service interface → 73

Supported operating tools Different operating tools can be used for local or remote access to the measuring device. Depending on the operating tool used, access is possible with different operating units and via a variety of interfaces.

Supported operating tools	Operating unit	Interface	Additional information
Web browser	Notebook, PC or tablet with Web browser	<ul style="list-style-type: none"> ▪ CDI-RJ45 service interface ▪ WLAN interface 	Special Documentation for device
DeviceCare SFE100	Notebook, PC or tablet with Microsoft Windows system	<ul style="list-style-type: none"> ▪ CDI-RJ45 service interface ▪ WLAN interface ▪ Fieldbus protocol 	→  185
FieldCare SFE500	Notebook, PC or tablet with Microsoft Windows system	<ul style="list-style-type: none"> ▪ CDI-RJ45 service interface ▪ WLAN interface ▪ Fieldbus protocol 	→  185

 Other operating tools based on FDT technology with a device driver such as DTM/iDTM or DD/EDD can be used for device operation. These operating tools are available from the individual manufacturers. Integration into the following operating tools, among others, is supported:

- FactoryTalk AssetCentre (FTAC) by Rockwell Automation → www.rockwellautomation.com
- Process Device Manager (PDM) by Siemens → www.siemens.com
- Field Device Manager (FDM) by Honeywell → www.honeywellprocess.com
- FieldMate by Yokogawa → www.yokogawa.com
- PACTWare → www.pactware.com

The associated device description files are available at: www.endress.com → Downloads

Web server

Thanks to the integrated Web server, the device can be operated and configured via a Web browser and via a service interface (CDI-RJ45) or via a WLAN interface. The structure of the operating menu is the same as for the local display. In addition to the measured values, status information on the device is also displayed and allows the user to monitor the status of the device. Furthermore the device data can be managed and the network parameters can be configured.



A device that has a WLAN interface (can be ordered as an option) is required for the WLAN connection: order code for "Display; operation", option G "4-line, illuminated; touch control + WLAN". The device acts as an Access Point and enables communication by computer or a mobile handheld terminal.

Supported functions

Data exchange between the operating unit (such as a notebook for example) and the measuring device:

- Upload the configuration from the measuring device (XML format, configuration backup)
- Save the configuration to the measuring device (XML format, restore configuration)
- Export event list (.csv file)
- Export parameter settings (.csv file or PDF file, document the measuring point configuration)
- Export the Heartbeat verification log (PDF file, only available with the "Heartbeat Verification" application package)

- Flash firmware version for device firmware upgrade, for instance
- Download driver for system integration
- Visualize up to 1000 saved measured values (only available with the **Extended HistoROM** application package →  219)

 Web server special documentation →  221

HistoROM data management

The measuring device features HistoROM data management. HistoROM data management comprises both the storage and import/export of key device and process data, making operation and servicing far more reliable, secure and efficient.

 When the device is delivered, the factory settings of the configuration data are stored as a backup in the device memory. This memory can be overwritten with an updated data record, for example after commissioning.

Additional information on the data storage concept

There are different types of data storage units in which device data are stored and used by the device:

	Device memory	T-DAT	S-DAT
Available data	<ul style="list-style-type: none"> ■ Event logbook such as diagnostic events for example ■ Parameter data record backup ■ Device firmware package ■ Driver for system integration for exporting via Web server, e.g: GSD for PROFIBUS PA 	<ul style="list-style-type: none"> ■ Measured value logging ("Extended HistoROM" order option) ■ Current parameter data record (used by firmware at run time) ■ Peakhold indicator (min/max values) ■ Totalizer values 	<ul style="list-style-type: none"> ■ Sensor data: nominal diameter etc. ■ Serial number ■ Calibration data ■ Device configuration (e.g. SW options, fixed I/O or multi I/O)
Storage location	Fixed on the user interface board in the connection compartment	Attachable to the user interface board in the connection compartment	In the sensor plug in the transmitter neck part

Data backup

Automatic

- The most important device data (sensor and transmitter) are automatically saved in the DAT modules
- If the transmitter or measuring device is replaced: once the T-DAT containing the previous device data has been exchanged, the new measuring device is ready for operation again immediately without any errors
- If the sensor is replaced: once the sensor has been replaced, new sensor data are transferred from the S-DAT in the measuring device and the measuring device is ready for operation again immediately without any errors
- If exchanging the electronics module (e.g. I/O electronics module): Once the electronics module has been replaced, the software of the module is compared against the current device firmware. The module software is upgraded or downgraded where necessary. The electronics module is available for use immediately afterwards and no compatibility problems occur.

Manual

Additional parameter data record (complete parameter settings) in the integrated device memory HistoROM backup for:

- Data backup function
Backup and subsequent restoration of a device configuration in the device memory HistoROM backup
- Data comparison function
Comparison of the current device configuration with the device configuration saved in the device memory HistoROM backup

Data transfer**Manual**

- Transfer of a device configuration to another device using the export function of the specific operating tool, e.g. with FieldCare, DeviceCare or Web server: to duplicate the configuration or to store in an archive (e.g. for backup purposes)
- Transmission of the drivers for system integration via Web server, e.g.: GSD for PROFIBUS PA

Event list**Automatic**

- Chronological display of up to 20 event messages in the events list
- If the **Extended HistoROM** application package (order option) is enabled: up to 100 event messages are displayed in the events list along with a time stamp, plain text description and remedial measures
- The events list can be exported and displayed via a variety of interfaces and operating tools e.g. DeviceCare, FieldCare or Web server

Data logging**Manual**

If the **Extended HistoROM** application package (order option) is enabled:

- Record up to 1 000 measured values via 1 to 4 channels
- User configurable recording interval
- Record up to 250 measured values via each of the 4 memory channels
- Export the measured value log via a variety of interfaces and operating tools e.g. FieldCare, DeviceCare or web server

16.12 Certificates and approvals



Currently available certificates and approvals can be called up via the product configurator.

CE mark	The device meets the legal requirements of the applicable EU Directives. These are listed in the corresponding EU Declaration of Conformity along with the standards applied. Endress+Hauser confirms successful testing of the device by affixing to it the CE mark.
RCM-tick symbol	The measuring system meets the EMC requirements of the "Australian Communications and Media Authority (ACMA)".
Ex approval	The devices are certified for use in hazardous areas and the relevant safety instructions are provided in the separate "Safety Instructions" (XA) document. Reference is made to this document on the nameplate.
Drinking water approval	<ul style="list-style-type: none"> ■ ACS ■ KTW/W270 ■ NSF 61 ■ WRAS BS 6920

Certification PROFIBUS

PROFIBUS interface

The measuring device is certified and registered by the PNO (PROFIBUS User Organization Organization). The measuring system meets all the requirements of the following specifications:

- Certified in accordance with PROFIBUS PA Profile 3.02
- The device can also be operated with certified devices of other manufacturers (interoperability)

Radio approval

The measuring device has radio approval.



For detailed information regarding radio approval, see Special Documentation

Other standards and guidelines

- EN 60529
Degrees of protection provided by enclosures (IP code)
- EN 61010-1
Safety requirements for electrical equipment for measurement, control and laboratory use - general requirements
- IEC/EN 61326
Emission in accordance with Class A requirements. Electromagnetic compatibility (EMC requirements).
- NAMUR NE 21
Electromagnetic compatibility (EMC) of industrial process and laboratory control equipment
- NAMUR NE 32
Data retention in the event of a power failure in field and control instruments with microprocessors
- NAMUR NE 43
Standardization of the signal level for the breakdown information of digital transmitters with analog output signal.
- NAMUR NE 53
Software of field devices and signal-processing devices with digital electronics
- NAMUR NE 105
Specifications for integrating fieldbus devices in engineering tools for field devices
- NAMUR NE 107
Self-monitoring and diagnosis of field devices
- NAMUR NE 131
Requirements for field devices for standard applications
- ETSI EN 300 328
Guidelines for 2.4 GHz radio components.
- EN 301489
Electromagnetic compatibility and radio spectrum matters (ERM).

16.13 Application packages

Many different application packages are available to enhance the functionality of the device. Such packages might be needed to address safety aspects or specific application requirements.

The application packages can be ordered with the device or subsequently from Endress+Hauser. Detailed information on the order code in question is available from your local Endress+Hauser sales center or on the product page of the Endress+Hauser website: www.endress.com.

Diagnostics functions

Package	Description
Extended HistoROM	<p>Comprises extended functions concerning the event log and the activation of the measured value memory.</p> <p>Event log: Memory volume is extended from 20 message entries (standard version) to up to 100 entries.</p> <p>Data logging (line recorder):</p> <ul style="list-style-type: none"> ▪ Memory capacity for up to 1000 measured values is activated. ▪ 250 measured values can be output via each of the 4 memory channels. The recording interval can be defined and configured by the user. ▪ Measured value logs can be accessed via the local display or operating tool e.g. FieldCare, DeviceCare or Web server.



Heartbeat Technology

Package	Description
Heartbeat Verification +Monitoring	<p>Heartbeat Verification Meets the requirement for traceable verification to DIN ISO 9001:2008 Chapter 7.6 a) "Control of monitoring and measuring equipment".</p> <ul style="list-style-type: none"> ▪ Functional testing in the installed state without interrupting the process. ▪ Traceable verification results on request, including a report. ▪ Simple testing process via local operation or other operating interfaces. ▪ Clear measuring point assessment (pass/fail) with high test coverage within the framework of manufacturer specifications. ▪ Extension of calibration intervals according to operator's risk assessment. <p>Heartbeat Monitoring Continuously supplies data, which are characteristic of the measuring principle, to an external condition monitoring system for the purpose of preventive maintenance or process analysis. These data enable the operator to:</p> <ul style="list-style-type: none"> ▪ Draw conclusions - using these data and other information - about the impact process influences (such as corrosion, abrasion, buildup etc.) have on the measuring performance over time. ▪ Schedule servicing in time. ▪ Monitor the process or product quality, e.g. gas pockets.

Cleaning

Package	Description
Electrode cleaning circuit (ECC)	The electrode cleaning circuit (ECC) function has been developed to have a solution for applications where magnetite (Fe_3O_4) deposits frequently occur (e.g. hot water). Since magnetite is highly conductive this build up leads to measuring errors and ultimately to the loss of signal. The application package is designed to AVOID build up of highly conductive matter and thin layers (typical of magnetite).

16.14 Accessories

 Overview of accessories available for order →  184

16.15 Supplementary documentation

 For an overview of the scope of the associated Technical Documentation, refer to the following:

- *W@M Device Viewer* (www.endress.com/deviceviewer): Enter the serial number from nameplate
- *Endress+Hauser Operations App*: Enter the serial number from the nameplate or scan the 2D matrix code (QR code) on the nameplate

Standard documentation **Brief Operating Instructions**

Brief Operating Instructions for the sensor

Measuring device	Documentation code
Proline Promag W	KA01266D

Brief Operating Instructions for transmitter

Measuring device	Documentation code
Proline 300	KA01405D

Technical Information

Measuring device	Documentation code
Promag W 300	TI01414D

Description of device parameters

Measuring device	Documentation code
Promag 300	GP01052D

Device-dependent
additional documentation

Safety instructions

Safety instructions for electrical equipment for hazardous areas.

Contents	Documentation code
ATEX/IECEX Ex d/Ex de	XA01414D
ATEX/IECEX Ex ec	XA01514D
cCSAus XP	XA01515D
cCSAus Ex d/ Ex de	XA01516D
cCSAus Ex nA	XA01517D
INMETRO Ex d/Ex de	XA01518D
INMETRO Ex ec	XA01519D
NEPSI Ex d/Ex de	XA01520D
NEPSI Ex nA	XA01521D
EAC Ex d/Ex de	XA01656D
EAC Ex nA	XA01657D
JPN Ex d	XA01775D

Remote display and operating module DKX001

Contents	Documentation code
ATEX/IECEX Ex i	XA01494D
ATEX/IECEX Ex ec	XA01498D
cCSAus IS	XA01499D
cCSAus Ex nA	XA01513D
INMETRO Ex i	XA01500D



Contents	Documentation code
INMETRO Ex ec	XA01501D
NEPSI Ex i	XA01502D
NEPSI Ex nA	XA01503D

Special Documentation

Contents	Documentation code
Information on the Pressure Equipment Directive	SD01614D
Radio approvals for WLAN interface for A309/A310 display module	SD01793D
Remote display and operating module DKX001	SD01763D

Contents	Documentation code
Heartbeat Technology	SD01744D
Web server	SD01656D

Installation Instructions

Content	Comment
Installation instructions for spare part sets and accessories	<ul style="list-style-type: none"> ▪ Access the overview of all the available spare part sets via <i>W@M Device Viewer</i> →  182 ▪ Accessories available for order with Installation Instructions →  184

Index

A

About this document	6
Access authorization to parameters	
Read access	65
Write access	65
Access code	65
Incorrect input	65
Adapters	25
Adapting the diagnostic behavior	148
Ambient temperature	
Influence	200
Ambient temperature range	23
Analog Input module	85
Analog Output module	87
Application	186
Applicator	186
Approvals	217

C

Cable entries	
Technical data	198
Cable entry	
Degree of protection	50
CE mark	10, 217
Certificates	217
Certification PROFIBUS	218
Checklist	
Post-connection check	51
Post-installation check	35
Cleaning	
Exterior cleaning	181
Interior cleaning	181
Commissioning	90
Advanced settings	112
Configuring the measuring device	91
Compatibility with earlier model	79
Conductivity	202
Connecting cable	36, 37
Connecting the measuring device	41
Connecting the signal cables	41
Connecting the supply voltage cables	41
Connection	
see Electrical connection	
Connection examples, potential equalization	44, 45
Connection preparations	40
Connection tools	36
Context menu	
Calling up	61
Closing	61
Explanation	61
Current consumption	197
Cyclic data transmission	84

D

Degree of protection	50, 200
Designated use	9
Device components	14
Device description files	79
Device documentation	
Supplementary documentation	8
Device locking, status	129
Device master file	
GSD	79
Device name	
Sensor	17
Transmitter	16
Device repair	182
Device type ID	79
DeviceCare	77
Device description file	79
Diagnostic behavior	
Explanation	144
Symbols	144
Diagnostic information	
Design, description	144, 147
DeviceCare	146
FieldCare	146
Light emitting diodes	142
Local display	143
Overview	151
Remedial measures	151
Web browser	145
Diagnostic list	175
Diagnostic message	143
Diagnostics	
Symbols	143
DIP switches	
see Write protection switch	
Direct access	63
Direct access code	57
Disabling write protection	126
Discrete Input module	88
Discrete Output module	88
Display	
see Onsite display	
Display and operating module DKX001	214
Display area	
For operational display	56
In the navigation view	58
Display values	
For locking status	129
Disposal	182
Document	
Function	6
Symbols	6
Document function	6
Down pipe	21
Drinking water approval	217

- E**
- ECC 118
 - Editing view 59
 - Input screen 60
 - Using operating elements 59, 60
 - Electrical connection
 - Degree of protection 50
 - Measuring device 36
 - Operating tools
 - Via PROFIBUS PA network 73
 - Via service interface (CDI-RJ45) 73
 - Via WLAN interface 74
 - Web server 73
 - WLAN interface 74
 - Electromagnetic compatibility 201
 - Electronics module 14
 - EMPTY_MODULE module 89
 - Enabling write protection 126
 - Enabling/disabling the keypad lock 66
 - Endress+Hauser services
 - Maintenance 181
 - Repair 182
 - Environment
 - Ambient temperature range 23
 - Mechanical load 201
 - Storage temperature 200
 - Vibration- and shock-resistance 201
 - Error messages
 - see Diagnostic messages
 - Event list 175
 - Event logbook 175
 - Ex approval 217
 - Extended order code
 - Sensor 17
 - Transmitter 16
 - Exterior cleaning 181
- F**
- Field of application
 - Residual risks 10
 - FieldCare 75
 - Device description file 79
 - Establishing a connection 76
 - Function 75
 - User interface 77
 - Filtering the event logbook 176
 - Firmware
 - Release date 79
 - Version 79
 - Firmware history 180
 - Fitted electrodes 212
 - Flow direction 22
 - Flow limit 203
 - Function check 90
 - Function scope
 - SIMATIC PDM 77
 - Functions
 - see Parameters
- G**
- Galvanic isolation 196
- H**
- Hardware write protection 127
 - Heavy sensors 22
 - Help text
 - Calling up 64
 - Closing 64
 - Explanation 64
 - HistoROM 120
- I**
- Identifying the measuring device 15
 - Incoming acceptance 15
 - Influence
 - Ambient temperature 200
 - Inlet runs 23
 - Input 186
 - Inspection
 - Installation 35
 - Received goods 15
 - Inspection check
 - Connection 51
 - Installation 21
 - Installation conditions
 - Adapters 25
 - Down pipe 21
 - Heavy sensors 22
 - Inlet and outlet runs 23
 - Installation dimensions 23
 - Mounting location 21
 - Orientation 22
 - Partially filled pipe 22
 - System pressure 24
 - Thermal insulation 24
 - Vibrations 24
 - Installation dimensions 23
 - Interior cleaning 181
- L**
- Languages, operation options 213
 - Line recorder 135
 - Local display 213
 - Navigation view 57
 - see Diagnostic message
 - see In alarm condition
 - see Operational display
 - Low flow cut off 196
- M**
- Main electronics module 14
 - Maintenance tasks 181
 - Replacing seals 181
 - Managing the device configuration 120
 - Manufacturer ID 79
 - Manufacturing date 16, 17
 - Materials 210
 - Maximum measured error 198

Measured values	
Calculated	186
Measured	186
see Process variables	
Measuring and test equipment	181
Measuring device	
Configuration	91
Conversion	182
Disposal	183
Integrating via communication protocol	79
Mounting the sensor	26
Mounting the ground cable/ground disks	27
Mounting the seals	27
Screw tightening torques	27
Screw tightening torques, maximum	27
Screw tightening torques, nominal	32
Preparing for electrical connection	40
Preparing for mounting	26
Removing	182
Repairs	182
Structure	14
Switch-on	90
Measuring principle	186
Measuring range	186
Measuring system	186
Measuring tube specification	208
Mechanical load	201
Medium temperature range	201
Menu	
Diagnostics	174
Setup	91, 92
Menus	
For measuring device configuration	91
For specific settings	112
Module	
Analog input	85
Analog output	87
Discrete Input	88
Discrete Output	88
EMPTY_MODULE	89
Totalizer	
SETTOT_MODETOT_TOTAL	86
SETTOT_TOTAL	86
TOTAL	85
Mounting dimensions	
see Installation dimensions	
Mounting location	21
Mounting preparations	26
Mounting tools	26

N

Nameplate	
Sensor	17
Transmitter	16
Navigation path (navigation view)	57
Navigation view	
In the submenu	57
In the wizard	57
Numeric editor	59

O

Onsite display	
Numeric editor	59
Text editor	59
Operable flow range	190
Operating elements	61, 144
Operating keys	
see Operating elements	
Operating menu	
Menus, submenus	53
Structure	53
Submenus and user roles	54
Operating philosophy	54
Operation	129
Operation options	52
Operational display	55
Operational safety	10
Order code	16, 17
Orientation (vertical, horizontal)	22
Outlet runs	23
Output	192
Output signal	192

P

Packaging disposal	20
Parameter	
Changing	64
Entering values or text	64
Parameter settings	
Administration (Submenu)	123
Analog inputs (Submenu)	95
Communication (Submenu)	94
Configuration backup (Submenu)	120
Current input	96
Current input (Wizard)	96
Current input 1 to n (Submenu)	132
Current output	98
Current output (Wizard)	98
Data logging (Submenu)	135
Define access code (Wizard)	122
Device information (Submenu)	178
Diagnostics (Menu)	174
Display (Submenu)	115
Display (Wizard)	108
Electrode cleaning circuit (Submenu)	118
Empty pipe detection (Wizard)	111
I/O configuration	95
I/O configuration (Submenu)	95
Low flow cut off (Wizard)	110
Process variables (Submenu)	130
Pulse/frequency/switch output	101
Pulse/frequency/switch output (Wizard)	101, 102, 105
Pulse/frequency/switch output 1 to n (Submenu)	133
Relay output	107
Relay output 1 to n (Submenu)	134
Relay output 1 to n (Wizard)	107
Reset access code (Submenu)	122
Sensor adjustment (Submenu)	113

- Setup (Menu) 92
- Simulation (Submenu) 123
- Status input 97
- Status input (Submenu) 97
- Status input 1 to n (Submenu) 132
- System units (Submenu) 93
- Totalizer 1 to n (Submenu) 113, 130
- Totalizer handling (Submenu) 134
- Value current output 1 to n (Submenu) 133
- Web server (Submenu) 72
- WLAN settings (Wizard) 118
- Partially filled pipe 22
- Performance characteristics 198
- Post-connection check (checklist) 51
- Post-installation check 90
- Post-installation check (checklist) 35
- Potential equalization 44
- Power consumption 197
- Power supply failure 197
- Pressure loss 203
- Pressure tightness 202
- Pressure-temperature ratings 202
- Process conditions
 - Conductivity 202
 - Flow limit 203
 - Medium temperature 201
 - Pressure loss 203
 - Pressure tightness 202
- Process connections 212
- Product safety 10
- Profile version 79
- Protecting parameter settings 126
- R**
- Radio approval 218
- RCM-tick symbol 217
- Read access 65
- Reading measured values 129
- Recalibration 181
- Reference operating conditions 198
- Registered trademarks 8
- Remedial measures
 - Calling up 145
 - Closing 145
- Remote operation 214
- Repair 182
- Repair of a device 182
- Repairs
 - Notes 182
- Repeatability 200
- Replacement
 - Device components 182
- Replacing seals 181
- Requirements for personnel 9
- Return 182
- S**
- Safety 9
- Screw tightening torques 27
 - Maximum 27
 - Nominal 32
- Sensor
 - Mounting 26
- Serial number 16, 17
- Setting the operating language 90
- Settings
 - Adapting the measuring device to the process conditions 134
 - Administration 121
 - Advanced display configurations 115
 - Analog input 95
 - Communication interface 94
 - Current input 96
 - Current output 98
 - Device reset 177
 - Device tag 92
 - Electrode cleaning circuit (ECC) 118
 - Empty pipe detection (EPD) 111
 - I/O configuration 95
 - Local display 108
 - Low flow cut off 110
 - Managing the device configuration 120
 - Operating language 90
 - Pulse output 101
 - Pulse/frequency/switch output 101, 102
 - Relay output 107
 - Resetting the totalizer 134
 - Sensor adjustment 113
 - Simulation 123
 - Status input 97
 - Switch output 105
 - System units 93
 - Totalizer 113
 - Totalizer reset 134
 - WLAN 118
- SETTOT_MODETOT_TOTAL module 86
- SETTOT_TOTAL module 86
- Showing data logging 135
- Signal on alarm 194
- SIMATIC PDM 77
 - Function 77
- Spare part 182
- Spare parts 182
- Special connection instructions 46
- Standards and guidelines 218
- Status area
 - For operational display 56
 - In the navigation view 57
- Status signals 143, 146
- Storage concept 216
- Storage conditions 19
- Storage temperature 19
- Storage temperature range 200
- Structure
 - Measuring device 14
 - Operating menu 53

Submenu

Administration	121, 123
Advanced setup	112
Analog inputs	95
Communication	90, 94
Configuration backup	120
Current input 1 to n	132
Data logging	135
Device information	178
Display	115
Electrode cleaning circuit	118
Event list	175
I/O configuration	95
Input values	131
Measured values	129
Output values	132
Overview	54
Process variables	130
Pulse/frequency/switch output 1 to n	133
Relay output 1 to n	134
Reset access code	122
Sensor adjustment	113
Simulation	123
Status input	97
Status input 1 to n	132
System units	93
Totalizer 1 to n	113, 130
Totalizer handling	134
Value current output 1 to n	133
Web server	72
Supplementary documentation	219
Supply voltage	197
Surface roughness	213
Switch output	194
Symbols	
Controlling data entries	60
For communication	56
For diagnostic behavior	56
For locking	56
For measured variable	56
For measurement channel number	56
For menus	58
For parameters	58
For status signal	56
For submenu	58
For wizard	58
In the status area of the local display	56
Input screen	60
Operating elements	59
System design	
Measuring system	186
see Measuring device design	
System integration	79
System pressure	24

T

Technical data, overview	186
Temperature range	
Ambient temperature range for display	213

Storage temperature	19
Terminal assignment	39
terminals	198
Text editor	59
Thermal insulation	24
Tool tip	
see Help text	
Tools	
Electrical connection	36
For mounting	26
Transport	19
TOTAL module	85
Totalizer	
Assign process variable	130
Configuration	113
Operation	134
Reset	134
Transmitter	
Turning the display module	34
Turning the housing	33
Transporting the measuring device	19
Troubleshooting	
General	139
Turning the display module	34
Turning the electronics housing	
see Turning the transmitter housing	
Turning the transmitter housing	33

U

Use of the measuring device	
Borderline cases	9
Incorrect use	9
see Designated use	
User interface	
Current diagnostic event	174
Previous diagnostic event	174
User roles	54

V

Vibration- and shock-resistance	201
Vibrations	24

W

W@M	181, 182
W@M Device Viewer	15, 182
Weight	
Transport (notes)	19
Wizard	
Current input	96
Current output	98
Define access code	122
Display	108
Empty pipe detection	111
Low flow cut off	110
Pulse/frequency/switch output	101, 102, 105
Relay output 1 to n	107
WLAN settings	118
WLAN settings	118
Workplace safety	10

Write access	65
Write protection	
Via access code	126
Via write protection switch	127
Write protection switch	127

www.addresses.endress.com
